

DECEMBER 1922

25 CENTS

# RADIO

Stanford Library  
NOV 22 1922  
B6



## Santa Claus adopts Radio

—he has at last found  
a set so simple and  
easy to operate it can  
be used every place  
he calls, a marvelous-  
ly efficient radio re-  
ceiver which requires  
neither aerial nor  
ground connection—

The Oard  
**Phantom**  
Receptor

ATLANTIC-PACIFIC  
RADIO SUPPLIES CO.  
646 Mission St. San Francisco

# Cunningham TUBES



The trade mark GE is the guarantee of these quality tubes. Each tube is built to most rigid specifications.

## Assure Clearest Broadcast Reception

Nationally known for Super-sensitive Detector Action and Distortionless Amplification, Cunningham tubes are ideal for use in your home receiving set.

The results obtained from the best radio sets depend largely upon the vacuum tubes used. Cunningham Detector Tubes insure clear reception—maximum signal strength and an absolutely quiet receiver in the absence of incoming signals.

Cunningham Distortionless Amplifier Tubes perform a great service. In making possible the reception of distant stations and the use of loud speaking telephones, these tubes bring into your home the music of great concerts and the singing of famous artists, aiding in the cultivation of the musical side of home life.

**TYPE C-300**  
Super-Sensitive  
**DETECTOR**

**\$5.00**

Amplifies  
as it  
Detects

**TYPE C-301**  
Distortionless  
**AMPLIFIER**

**\$6.50**

**Patent Notice** Cunningham tubes are covered by patents dated 11-7-05, 1-15-07, 2-18-08 and others issued and pending. Licensed only for amateur or experimental uses in radio communication. Any other use will be an infringement.

*E. J. Cunningham*

**Home Office:**  
248 First Street  
San Francisco, Calif.

**Eastern Representative:**  
154 West Lake St.  
Chicago, Illinois

# Burgess, the *Radio* Battery —construction fully patented

When you buy a Burgess "B" Battery you get more than long life, noiselessness, high capacity and moderate price. You get also Burgess special radio construction, perfected by wireless specialists and fully patented! This exclusive *radio* construction is found in no other battery on the market to-day.

What does this mean to users of radio batteries? It means clear receiving. It means low-

est cost per hour of service. It means long shelf life and highest current capacity. It means that Burgess "B" Batteries are the finest radio batteries it is possible to produce. Don't take our word for it—ask any radio engineer.

Leading manufacturers of radio equipment specify "Burgess." Burgess "B" Batteries are handled by all progressive jobbers and dealers. "Look for the Black and White Stripes." And if your dealer doesn't handle Burgess "B," just address:

## BURGESS BATTERY COMPANY Engineers—Dry Batteries—Manufacturers

Offices and Warehouses at:

CHICAGO, ILL., 111 W. Monroe St. NEW YORK, N. Y., 50 Church St. BOSTON, MASS., 136 Federal St.  
ST. PAUL, MINN., 2362 University Ave. KANSAS CITY, MO., 2109 Grand Ave. MADISON, WIS., Main and Beardsley Sts.

In Canada: BURGESS BATTERIES, Ltd.  
Winnipeg, Toronto, Montreal

# BURGESS "B" BATTERIES

"ASK ANY RADIO ENGINEER"



Tell them that you saw it in RADIO

# RADIO

Established 1917 as Pacific Radio News

Volume IV

for DECEMBER, 1922

Number 12

## CONTENTS for DECEMBER, 1922

	Page
Radiatorial Comment .....	9
Exit "KUSD" .....	10
Radio Tuning Devices .....	11
<i>By ELLERY W. STONE</i>	
The Professional Radio Operator .....	13
<i>By VOLNEY G. MATHISON</i>	
The Code and Its Difficulties .....	15
<i>By CARLOS S. MUNDT</i>	
A Four-Tube Radiophone Transmitter .....	16
<i>By FRANCIS J. ANDREWS</i>	
Simplified Theory of the Federal Arc Transmitter .....	17
<i>By V. FORD GREAVES</i>	
Radio in Australia .....	18
<i>By L. S. LANE</i>	
A New Radio Frequency Amplifier .....	19
<i>By E. M. SARGENT</i>	
Two-Stage R. F. Amplifier and Detector .....	20
<i>By WM. J. O'NEILL</i>	
Radio Broadcasting in Great Britain .....	21
Roundabout Remarks on Radio Remembrances .....	22
<i>By S. P. WRIGHT</i>	
Christmas Phantoms .....	23
<i>By EARL ENNIS</i>	
A Regenerative Hook-Up for the Loose Coupler and Vacuum Tube .....	24
<i>By CHAS. R. FRYE</i>	
Inductance Design .....	25
<i>By JESSE MARSTEN</i>	
Operation and Care of Motors and Generators .....	27
<i>By D. B. MCGOWN</i>	
Are Shorter Wavelengths Worth While? .....	29
<i>By WALTER EMMET</i>	
Power Supply for Vacuum Tube Transmitters .....	30
<i>By CHARLES K. FULGHUM</i>	
News of The Broadcasters .....	32
News of the Radio Clubs .....	35
DX Work during September and October .....	37
<i>By LAWRENCE MOTT</i>	
Recent Radio Patents .....	38
Queries and Replies on C. W. Practice .....	39
<i>By G. M. BEST</i>	
New Apparatus and Supplies .....	40
Calls Heard .....	41

RADIO is Published Monthly by the Pacific Radio Publishing Co., Inc., Pacific Building, San Francisco, Calif.

ARTHUR H. HALLORAN, *Editor.*

LAWRENCE MOTT, *Associate Editor.*

LOUIS TREVISO, *Art Editor*

GERALD M. BEST, *Technical Adviser.*

O. SCHUWENDT, *Engineering Draughtsman.*

H. W. DICKOW, *Advertising Manager.*

Branch Offices: 17 West 42nd St., New York City, Telephone Longacre 8248, 6442 Ingleside Ave., Chicago; 761 Spitzer Bldg., Toledo, Ohio; 52 Irving Street, Boston; 1102 Republic Bldg., Kansas City, Mo.; Suite 510, 456 So. Spring St., Los Angeles, Cal.; M. C. Mogensen & Co., Inc., Securities Bldg., Seattle, Wash.

Advertising Forms Close on the First of the Month Preceding Date of Issue

Issued Monthly, 25c a copy. Subscription price \$2.50 per year in the U. S., \$3.00 per year elsewhere. Instructions for change of address should be sent to the publisher two weeks before the date they are to go into effect. Both old and new addresses must always be given.

Entered as second-class matter at the Post Office at San Francisco, Calif., under the Act of March 3, 1879.

Copyright, 1922, by the Pacific Radio Publishing Co.

## Forecast of Contributions for January Issue

To start the New Year there will be published the first of a series of practical articles in narrative form by S. P. Wright. These articles will give the information that every amateur should know but presented with a fictional background that will entertain the novices as well as jog the memories of the amateurs. The first in the series—"Wildcat Builds a Tuner," a story on the use of a wave trap—and then by an account of an exciting radio game for club meetings. In the quaint style of "And It Came to Pass," Mr. Wright will also have some appropriate remarks about New Year Resolutions.

D. B. McGown, assistant radio inspector for the Sixth District, has written another one of his constructional articles, this being a description of a receiving set especially adapted for use with 32 volt current from a farm lighting set, although the directions are given for using current of other voltages. This article should prove helpful to anyone about to build a new receiving set.

Some good stuff for the transmitting amateur will be found in Charles K. Fulghum's suggestions on the "Construction and Use of A Filament Heating Transformer for C. W. Transmission," and in Jesse Marsten's notes on "Vacuum Tubes in Parallel," which includes a comparison of master oscillators and self-exciting oscillators and gives suggestions for securing greater power output.

A fiction writer new to readers of RADIO is Albert Lippinpool, who has a good story on "The Radium Bulb," with special illustration by C. J. Dow. Speaking of Dow, we suggest that you look at his list of Calls Heard as published in this issue—"Twill make you green with envy."

Volney G. Mathison, in his fifth article on "The Practical Radio Operator," tells about getting the first ship and gives some experienced suggestions about the operator's conduct aboard ship.

Ellery W. Stone will present the seventh and eighth assignments of the University of California Extension Division Correspondence Course on Elementary Radio. His subjects are "Detection" and "Telephone Receivers."

G. M. Best, in addition to his answers to queries, will write of his experience in eliminating inductive interference from high tension power conductors, a phenomenon that had previously been ascribed to static.

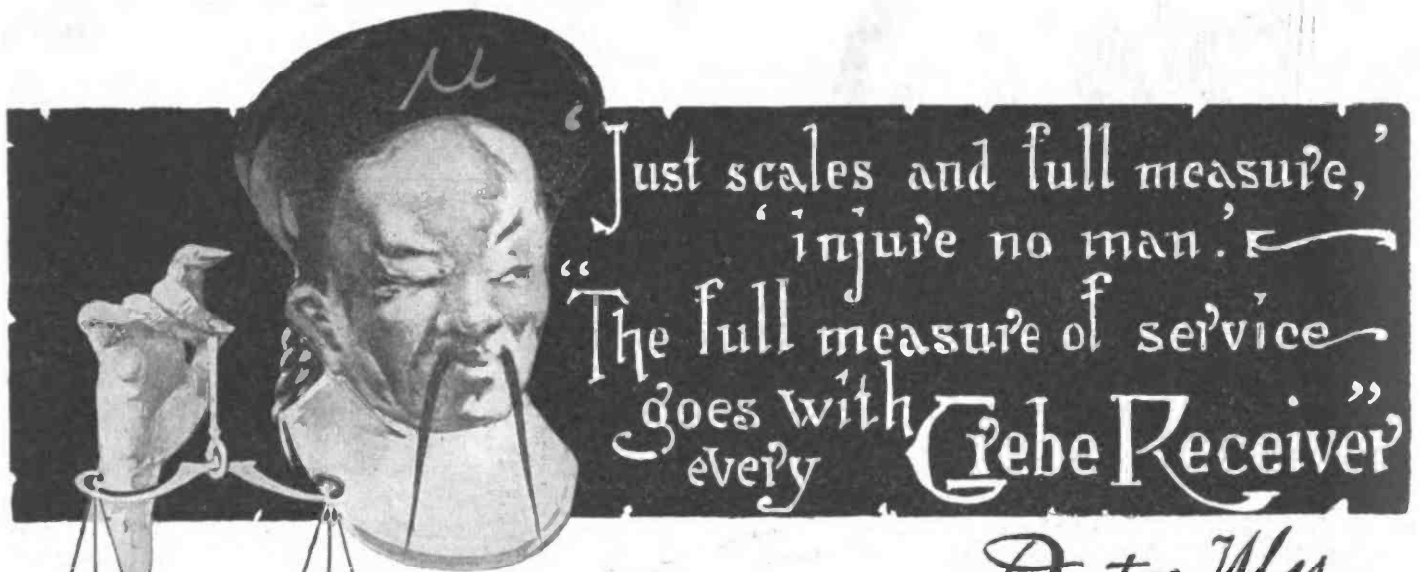

‘Just scales and full measure,  
 ‘injure no man.’  
 “The full measure of service  
 goes with **Grebe Receiver**”  
 every

*Doctor May.*

**ANYONE** who knows a radio will tell you how well the Grebe CR-5 performs on the daily concerts, lectures, etc., in the air.

Two simple tuning adjustments are used. Tiresome adjustments, unpleasant interruptions are unnecessary with the Grebe CR 5. Its

range, 150—3000 metres.

Ten years experience in satisfying a critical radio public has taught us how to build it for your year-round enjoyment.

If your Dealer does not sell Grebe Radio Apparatus, send us his name and receive interesting circular.

**A. H. GREBE & CO., Inc.**

Van Wyck Blvd., Richmond Hill, N. Y.

General Offices and Factory

Western Branch—451 East 3rd St., Los Angeles, Cal.

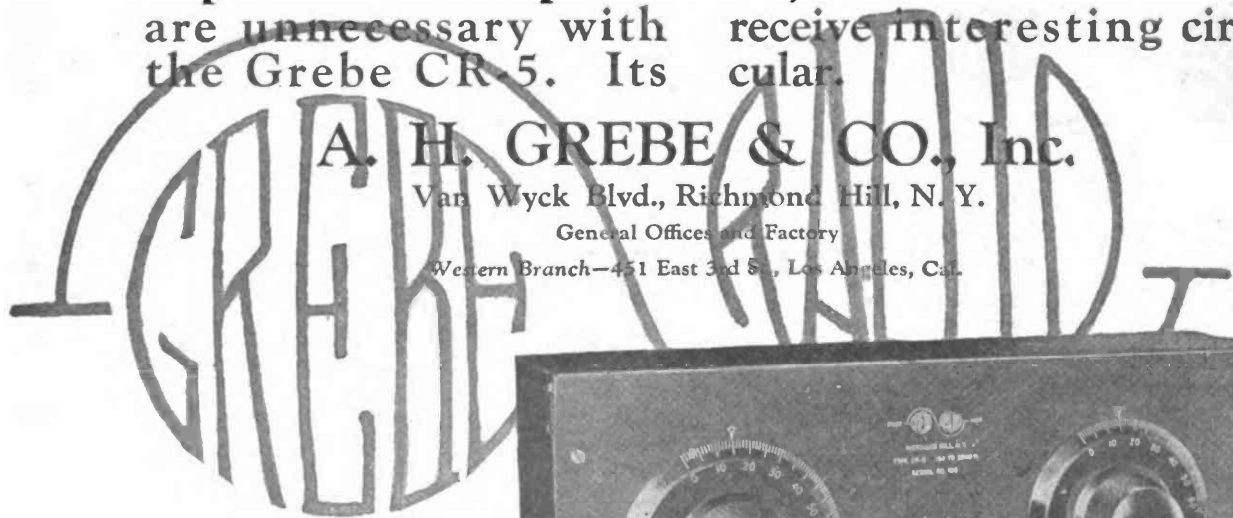

Licensed under  
 Armstrong U. S. Patent,  
 No. 1113149.



Tell them that you saw it in RADIO

# Santa Headquarters

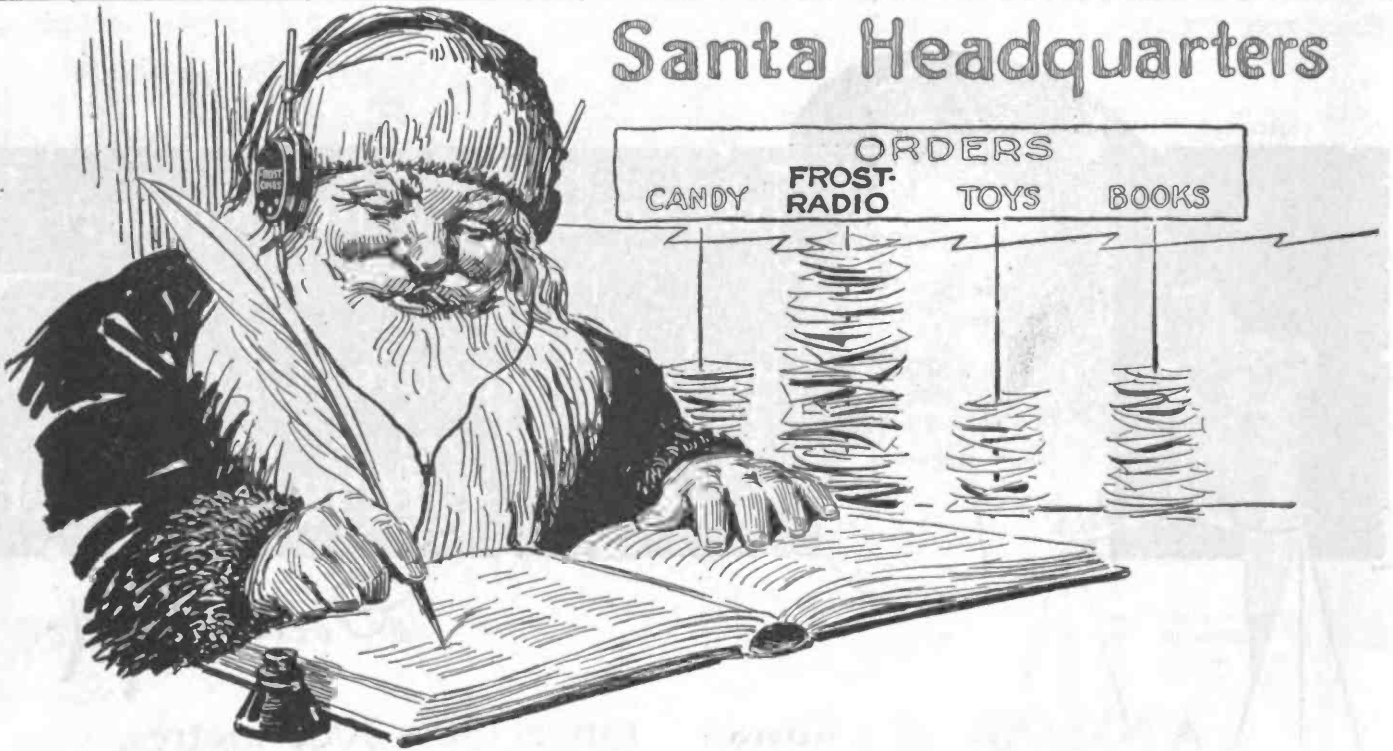

Santa's Taking His Orders by Radio This Year—And They Are Demanding

## FROST-RADIO



**FROST FONES**

No. 162  
2000 Ohm  
Set.. \$5.00

No. 163  
3000 Ohm  
Set.. \$8.00

A Quality Achievement.

Ideal Receivers for use with Home Radio Sets.

Combined maximum efficiency with permanent sensitiveness.

These Radio accessories are the big hit of the season. They win the whole-hearted approval of every Radio "fan." The reason is simply that every item is built to perform best the particular function for which it is intended—priced to satisfying trade-holding levels and quality unsurpassed.

**FROST-RADIO** Is the Front Door Key to Radio Satisfaction!

On these two pages we show some Frost-Radio leaders. Your local dealer or jobber can supply you. Get in touch with him today.



**HERBERT**  
NATIONAL FACTORY DISTRIBUTORS  
154 W. LAKE ST.

Tell them that you saw it in RADIO



## —And a Flock of Radio “Bugs” Step Up to Broadcast Their Christmas Orders!

Three million eager American boys know that this year Santa won't have any excuse for mistaking their orders on account of poor writing. Billie, last year got a Doll and he wrote for a Ball! Santa's Frost-Fones are a guarantee of clear accurate Radio reception. They will bring satisfaction to thousands of homes through their dependable service.

### A New Plug for 60c



No. 139—All Terminal Plug—60c

#### Arrived In Time for Xmas!

The new member of the Frost-Radio family

This plug (shown above) will be the talk of the Radio field. Priced within reach of every purse. A handsome, highly finished, strong, light weight plug with conductive parts of machined brass. Handle is one piece and ground from solid rubber. Screw binding post terminals take cord-tips and terminals of all types. Adjustable brass thumb screws connect wire to plug and insure positive contact. No tools needed. Unnecessary to cut telephone tips. Not affected by body capacity and fits any standard jack.



Showing screw binding post terminals with phone cord tips inserted.

### FROST-RADIO PLUGS

Small, neat and perfectly finished. Specially designed for Radio Panel Work. Interchangeable with other standard makes.

### Frost-Radio Extension Cord and Plug

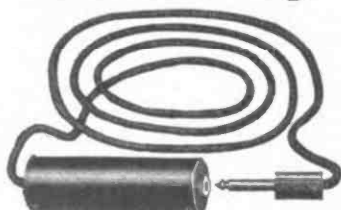

Comes in lengths from 10 to 100 feet. Loud speaker can be placed anywhere and connected with Radio set with Frost-Radio Extension Cord.

The Better You Know the Magic of Radio, the Better You Will Appreciate Frost-Radio Accessories!

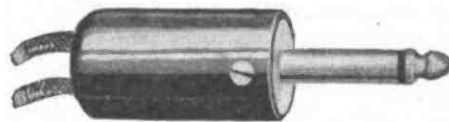

New type of plug taking cord tips directly. Not necessary to remove tips. Handsomely finished. Polished hard rubber sleeve covers tips and is held firmly by tightening one screw. Nothing to come loose. Cord Tip Plug No. 137—Each, \$1.25.

A Frost-Radio Multiphone Plug for 4 or less Headsets. Fits any jack.

Packed in individual container. No. 138—Price each, \$2.50.

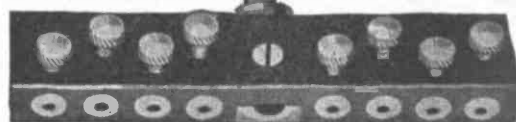

# H. FROST

TO THE ELECTRICAL-RADIO JOBBER  
CHICAGO, ILL. U.S.A.

Tell them that you saw it in RADIO



A big part of the enjoyment of Radio is in the assembling of your own set. Besides, when you do this, you cannot help but learn, and more quickly, the facts you need to know for better Radio receiving.

Install Kellogg dependable, high quality, radio parts in your set; for instance, a Kellogg variable condenser with vernier. With this piece of apparatus, accurate and careful tuning is assured. Kellogg variable condensers are a very important and necessary equipment in accurate selecting of various broadcasting stations.

With the condenser, get a Kellogg Bakelite molded variometer which can be assembled as a variocoupler, if desired, according to the circuit.

Also three Kellogg dials. These likewise are an ex-

ceptional product. They come in four inch and three inch diameter, and are finished on both sides with bushings which allow of attachment to shaft of various dimensions.

We do not believe there is a better tube socket than the Kellogg. Kellogg jacks are a standard product, and like Kellogg receivers and other parts, have been manufactured by this company steadily for over twenty-five years, assuring the product of highest value for the cost.

Who in your family is the Radio fan?

Have each member of the family give him one part, and don't forget to include a Kellogg head set which is the lightest on the market, and its design is based on standard receiver production of a most successful line of equipment.

*If your dealer does not handle Kellogg, write us for our illustrated bulletins, and we would appreciate receiving his name and address.*

### **KELLOGG SWITCHBOARD & SUPPLY CO.**

Main Offices and Factory: Chicago, Illinois

*Builders of High Grade Telephone Equipment for Twenty-five Years*

**Broadcasting to you A Merry Christmas and Good Wishes**



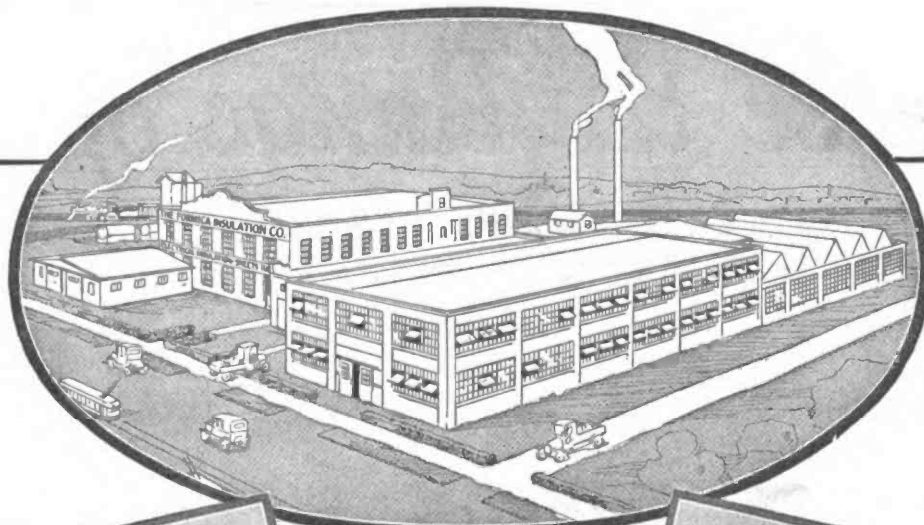

The Formica plant today

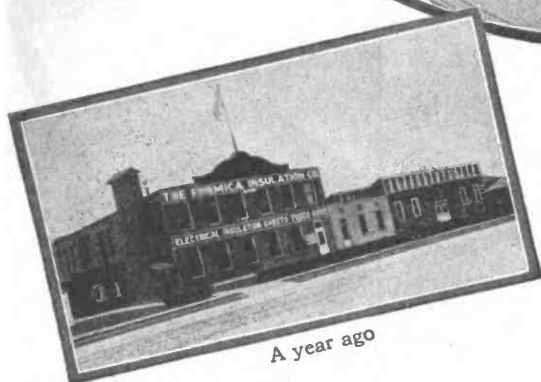

A year ago

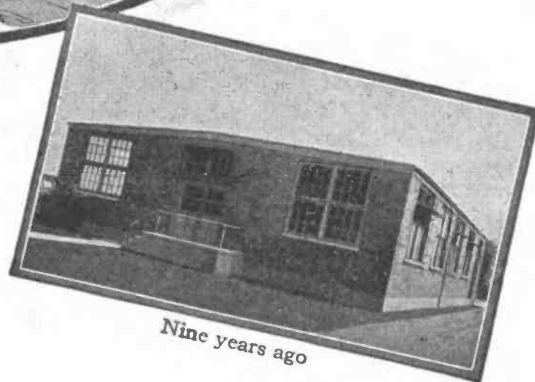

Nine years ago

# Appreciation and Progress

**N**INE years ago the Formica Insulation Company began business in the small building shown at the right.

Two years ago the demand for the product from every branch of the electrical industry, forced a move to the building shown at the left where capacity was greatly increased.

Now, recently constructed additions to that plant have brought into existence the plant shown at the top—a plant with more than twice the capacity of the company—a year ago—and the largest in the industry.

Appreciation of a better insulating product—one that at very slightly increased costs removes thousands of troublesome and costly possibilities for insulation failure—has built the business.

*If you do not know or use Formica write us now for literature and prices*

**THE FORMICA INSULATION COMPANY**  
4616 Spring Grove Ave., Cincinnati, Ohio

**SALES OFFICES**

50 Church Street...New York, N. Y. 414 Finance Bldg...Cleveland, Ohio 422 First Avenue...Pittsburg, Pa.  
9 South Clinton Street...Chicago, Ill. 1042 Granite Bldg...Rochester, N. Y. 1210 Arch Street...Philadelphia, Pa.  
415 Ohio Building...Toledo, Ohio 313 Title Building...Baltimore, Md. Sheldon Building, San Francisco, Cal.

# FORMICA

A Laminated Phenolic Condensation Product  
**SHEETS TUBES RODS**

Tell them that you saw it in RADIO

# Increase the Range of your AERIOLA SR. with the new AC AMPLIFIER



**T**HE new AC Amplifier, to a considerable extent, increases the reception possibilities of the Aeriola Sr. With head telephones and the AC Amplifier reception ranges of one hundred to three hundred miles become possible for the owner of an Aeriola Sr., depending on local conditions. Used with the Vocarola loud-speaker, the Aeriola Sr. and AC Amplifier fill a whole room with music and speech received over distances of ten to thirty miles.

Anybody can make the simple connections required, including mother and the girls.

See this New Amplifier at Your Dealer

**Radio**  **Corporation**  
of America

Sales Dept. Suite 2059  
233 Broadway  
New York City

District Office  
10 South La Salle St.  
Chicago, Ill.



## AERIOLA AMPLIFIER

Model AC  
Complete with 2WD-11A vacuum tubes  
(without batteries)

\$68.00



## VOCAROLA LOUD- SPEAKER

Model LV  
\$30.00



This symbol of quality  
is your protection

Before buying radio apparatus, always consult the book "Radio Enters the Home." Price 35 cents by mail or at your dealer.

## Radiatorial Comment

**A** CHEERY CHRISTMAS TO YOU, GOOD FRIEND! RADIO extends to you the hand of radio fellowship at this Festive Season and cordially hopes that your radiations will grow none the less.

In the year that is now rapidly passing a-down the aisles of the Present, and turning the corner into the dim archways of the Past, RADIO has tried to be of interest to you all! In its pages the editors have sought to place before you material that would be of interest to the ambitious beginner in radio, as well as to those that have progressed far along the way.

We have endeavored to avoid useless, and sometimes acrimonious, discussions as to various methods of transmission, feeling that it is every law-abiding operator's inalienable right to develop along *his own* lines, and after his own methods! This wee, sma' world in which we move would be a deadly dull place if we ALL thought alike, and acted alike!

There is ONE thing, however, that most amateurs have in common—and that is the very human trait of wanting to *help t'other fellow*! There seems to be, very strongly developed, in the great class of amateur operators a spirit of friendly co-operation that speaks WELL for the youth of these great United States of ours! At times the Green Eyed monster rears its ugly head—but not for long! "*Live and help live*" must always be the motto in the fair-minded operator's inner Consciousness!

Any fool can *destructively* criticize!

And no one gets any for'arder!

The thing to do is to *constructively* help!

And then everyone is—happy!

The chief factor of the great power of our blessed Nation, among the nations of the world, is our *cohesiveness*! In unity—of anything—there is STRENGTH! In warring "factions," is dangerous weakness!

Because 99% of the amateur radio operators of this land obey the laws, and pull together, their great body has earned—and won—recognition, as well as respect, at Washington. The result has been that laws of much benefit to the amateur have been passed, and his ways smoothed as far as logically possible!

The radio army is recruiting rapidly. Already the awkward squads—the tyros—outnumber the old guard a hun-

dred to one. Their requirements oft seem unreasonable—an unreasonableness based on ignorance. If they knew better they would be more reasonable. To show them the right—to teach them—is at once the duty and the privilege of the old guard.

To try to down the flood of public opinion with opposition is suicide. But by gently leading it into the channels of understanding its power may be utilized for the benefit of all. Congress must be urged to pass the new laws that are needed to improve conditions on the air.

In the persons of the Secretary of Commerce, and the Commissioner of Navigation, radio effort is indubitably blessed! We extend to these two gentlemen our warmest Yule-tide Greetings, at the same time venturing to express our KEEN appreciation for all that they have done toward assisting the amateur! We have but to look at the endless difficulties, the drastic laws, etc., that hamper amateurs of other nations, to realize how extraordinarily fortunate we Americans are.

The thing, then, to do is to abide by our Radio Laws, thus proving that we are appreciative, and that we intend, to the best of our abilities, to show our worth.

And when the Christmas bells ring in their gladsome tidings we may be proud of our association with this wonderful agency which, more than any other, is destined to bring about world understanding and unity. So send it and receive it—"*Peace on Earth, Good Will Toward Men*"—by radio.

MAJOR LAWRENCE MOTT



**T**O the editor, the most interesting departments of RADIO are the "Letters to the Editor" and "Calls Heard" because they indicate what our readers are thinking and doing. 'Tis with regret that hundreds of complimentary letters cannot be published because they would crowd out material of greater interest to the reader. We are deeply appreciative of these bouquets and take this opportunity to thank the senders. Especial attention is called to some of the remarkable long distance records that are modestly listed among the "Calls Heard." In case of failure of other methods of communication or in other national emergency the nation has at its service hundreds of amateur operators ready and able to transmit messages across the continent and even across the sea. The maintenance of this reserve is the fundamental reason why every possible consideration should be shown the radio amateur.

## Exit "KUSD"

*That fact may be more dramatic than fiction is demonstrated by this graphic portrayal of the important part played by radio in the rescue of the passengers and crew of the ill-fated "City of Honolulu." Well-deserved tribute is paid to the former amateur operators who manned the vessel's radio cabin.*

"CQ! CQ! CQ! - de KUSD - fire aboard ship please stand by for position!"

This dramatic message, flashed across the Pacific ocean at 5:56 o'clock on the morning of October 12th, brought to a listening radio world, the first intimation that the palatial steamer *City of Honolulu* was afire 700 miles off the California coast with 262 persons, passengers and crew, aboard.

The vessel had cleared from Honolulu on October 7. It carried a standard Navy type Radio Corporation of America 2 k. w. spark set, in charge of Chief Operator Walter P. Bell of Oakland, Second Operator H. D. Hancock of Venice, and Third Operator N. C. Kumler of Yakima, Wash.,—all former amateurs. The radio staff worked in three shifts of four hours on and eight hours off duty.

Kumler was on duty when the fire broke out, but he knew nothing of it. He had the "dog-watch," from midnight until 4 a.m., and there had been plenty to keep him awake. A two-hour message from Pearl Harbor was one thing. Static was another. Off to the Westward "WML" the *Lurline* had been handling re-transmission stuff to "KHK"—Wahaiwa, Hawaiian Islands—when Kumler decided to clean up. He had one for the *Manoa*—"WMQ."—and reached for his key.

"WMQ de KUSD!" he called, signing the call for the *City of Honolulu*.

"Go ahead," sang out the *Manoa*, two hundred miles away.

Kumler reached for his key . . .

Into the radio room came the sudden ring of the bridge telephone. Kumler paused and glanced at his clock. It was 5:40 a.m., just before dawn. Instantly he knew that something had happened. Telling the *Manoa* to wait a minute, he answered the telephone.

Captain H. R. Lester, the vessel's commander, spoke to him from the

bridge. "Wake the other operators and report to the bridge!" he commanded.

Kumler knew then that something serious had occurred. He immediately awakened Chief Operator Bell, who slept in an adjoining cabin, informed him of the captain's orders and rushed to the bridge. There he was told the ship was on fire and to ask all vessels to stand by until position computations were made.

broke the silence of the air with the vessel's position—"Latitude 31-07 North, Longitude 131.40 West."

Three acknowledgments came back from that position announcement—the *Enterprise*, the *City of Los Angeles* and the *Thomas*. In the meantime KPH took official charge of the air, broadcasting a "QRT" to all vessels to "stop sending." NPG, Goat Island, similarly ordered all naval vessels into silence and a tomb-like quietness dropped over 6,000 miles of busy night air.

Aboard ship, the battle against the flames had begun. The wireless operators stayed at their posts, oblivious to that portion of passing events. Bell took charge of the key work, the other two maintaining a messenger service between the radio room and bridge to facilitate orders from the ship's commander.

As all the world knows, the battle of the crew and the ship's officers against the encroaching

flames was a losing one. Smoke was everywhere, swirling down upon the decks and the radio room in great billowing clouds. Passengers were running to and fro gathering up personal belongings. The crew were preparing the lifeboats for the inevitable. Through it all, three radio operators, with impassive faces, played the game with Death—and won.

The *City of Honolulu* tilted over on her beam ends as the fight went on. She wallowed with a list of thirty-five degrees to starboard. Bell braced his foot against the table. His pencil and message blanks went skidding downward. Articles fell out of the racks. The chairs slid the floor and banked against the wall. The switchboard was tilted at a crazy angle. But the outside radio world knew nothing of this until afterward. At the time Bell's sending was smooth, steady—as cool as his nerves.

*Continued on page 72*

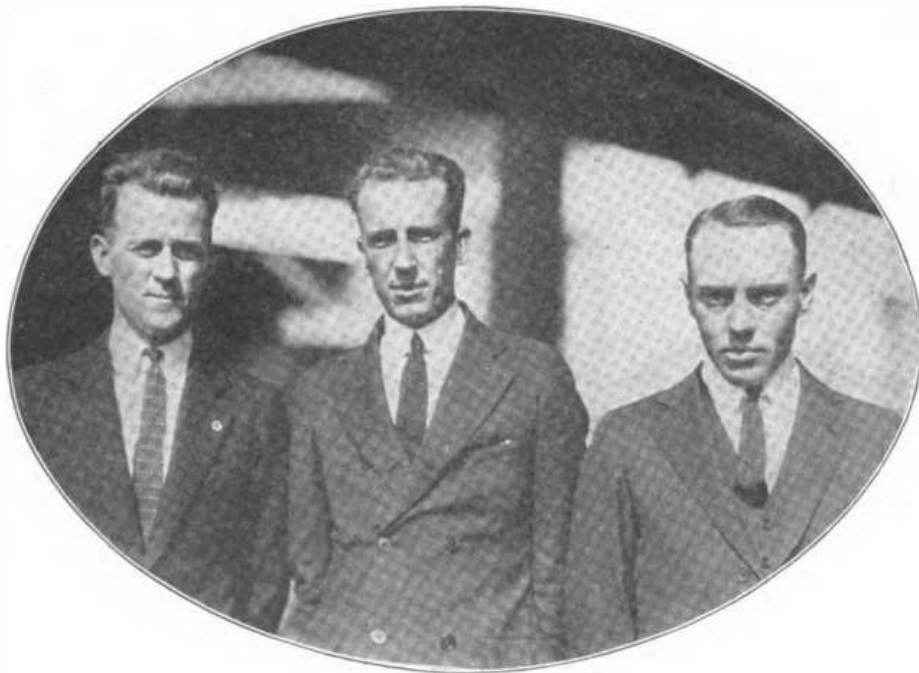

W. P. Bell

H. D. Hancock

N. C. Kumler

When this was reported back to Chief Operator Bell, the latter sent out the "CQ" call, noted above, which shocked a whole West coast into instant attention, and turned half a score of half-awake operators into competent, alert machines.

East and West sped the "CQ" call. It was caught at Pearl Harbor. It was picked up by three vessels—the *Enterprise*, the *City of Los Angeles*, and the U. S. Army Transport *Thomas* many miles away. It drummed into the ears of the night operator at KPH, the Radio Corporation station at Marshall, Calif., and throwing on his full power he flashed back an answer.

"Any report?" he asked.

"Not yet," said Bell, sighing with relief. For, even in the annals of quick radio, that was somewhat of a record—a matter of three seconds response to a call from mid-ocean.

Two minutes after the "CQ" call went forth, Chief Operator Bell again

# Radio Tuning Devices

By Ellery W. Stone

*This, the fifth and sixth assignments of the correspondence course in Elementary Radio being conducted by the University of California Extension Division, discusses the theory and practice of single and double slide tuners, variable condensers, loose couplers, variometers, vario-couplers and honeycomb coils. Previous assignments, question sheets and supplementary data may be secured from the Extension Division, 301 California Hall, Berkeley, Calif.*

## SINGLE AND DOUBLE SLIDE TUNERS

In the last assignment, we studied the theoretical side of tuning the receiving antenna to the frequency of the incoming radio wave. In this assignment, we shall consider the design and construction of some of the instruments which are used in actual practice to effect these results. Fig. 21 illustrated the earliest type of tuned receiver, one in which the detector was inserted directly in the antenna circuit. Such a circuit did not prove satisfactory in practice, however, because of the ensuing high damping of the receiving antenna circuit caused by the introduction of the high resistance of the crystal detector. Actually, in the pioneer circuits, a high resistance device called the *coherer* was used in place of the crystal detector, which was not developed until later. However, for our purposes, and in order that you may not have to spend time studying the operation of a device which is now of merely historic interest, we shall consider the use of the crystal detector only.

It became necessary, therefore, as we learned in the last assignment, to remove the detector from the antenna circuit and to couple it inductively to this circuit instead. In this connection, we have already studied the action of the two coil receiving transformer, but there is another type which was first used and which, because of its simplicity, is again finding favor in the reception of radio-telephone broadcasting. This is called the single coil or *auto-transformer*.

Fig. 24 shows the two coil receiving transformer, whose action we have already investigated, consisting of a primary coil and a secondary coil. The dotted lines threading the two coils represent the magnetic field or *flux*, as it is called, generated by the alternating current in the primary coil. This magnetic field threads the secondary coil and induces, by the principle of electromagnetic induction, an alternating potential of the same frequency across the terminals of the secondary coil. In Fig. 24, the primary coil is shown as consisting of three turns of wire while the secondary consists of four turns.

Fig. 25 illustrates another type of receiving transformer called the auto-transformer, the transformer action being limited to, or is self-contained in, one coil, although the single coil really contains both a primary and secondary.

This coil is seen to consist of four turns of wire. Taps are taken off three of the turns so as to form the primary while the entire coil is used as the secondary. In so far as the number of turns in both primary and secondary is concerned, therefore, this arrangement is exactly similar to that shown in Fig. 24—the alternating current which flows through the three turns that comprise the primary inducing an alternating potential across the four turns of the secondary.

It will be seen, however, that while there is no actual electrical connection

transformer in place of the inductive receiving transformer. The small fixed condenser, *C*, called a *stopping condenser*, shown shunted across the telephone receivers is not for tuning purposes. Its function and that of the detector will be more thoroughly discussed in a later assignment. For the present, we shall confine ourselves to the construction and operation of the tuning coil.

This coil consists of a single layer of copper wire, insulated with a covering of cotton, silk, or enamel lacquer. This layer is wound on a tube of insulating material, such as cardboard. The tube,

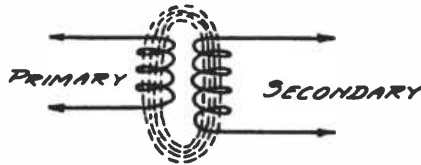

FIG 24



FIG 25

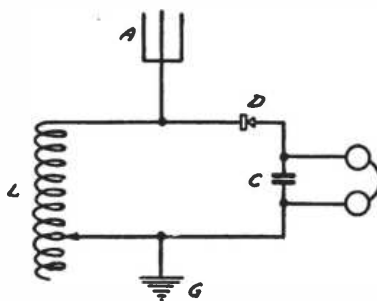

FIG 26

Fig. 24. Two Coil Receiving Transformer.  
Fig. 26. Receiving Circuit with Single Slide Tuner.

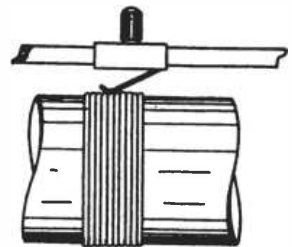

FIG 27

Fig. 25. Auto-transformer.  
Fig. 27. Detail of Slider Construction.

between the primary and the secondary of the receiving transformer shown in Fig. 24, there is electrical contact between the primary and the secondary of the auto-transformer of Fig. 25. For this reason, the primary and secondary of an auto-transformer are said to be *conductively* coupled to each other, although the induction of potential across the terminals of the secondary in both cases is by *inductive* means.

In Fig. 22, we showed how the detector could be removed from the antenna circuit so as to reduce the latter's resistance. The circuit shown in Fig. 26 also accomplishes the same purpose by the use of a single slide tuner or auto-

irrespective of the material of which it is made, is called the *core*.

The inductance of this coil may be varied so as to increase or decrease the wavelength of the receiving antenna by adding to or reducing the number of turns. This is because the inductance of a coil, as we have seen, depends upon the size and number of turns of which it is composed. So far as the electrical characteristics in this circuit are concerned, the coil may be considered as consisting only of the number of turns actually in the circuit between the lead from the antenna and the arrow, representing the slider which is connected to the ground.

Since the slider must make contact with each turn of the coil, it is necessary to remove a small portion of the insulation from each turn over the entire length of the coil. This is most easily accomplished when enameled wire is used, since the enamel may be removed by sandpaper. After the enamel has been removed by this means, a soft cloth should be rubbed over the exposed surface of the wire in order to remove any fine bits of copper which may be lodged between adjacent turns and which would thus short-circuit them. Such a short-circuited turn would really constitute a single turn, short-circuited secondary and due to its low resistance, a large induced current would flow in it. Such a flow of current would thus extract a wasteful amount of energy from the antenna circuit.

The proper size of the wire ranges from No. 22 to No. 28, B.&S. gauge, No. 24 being probably the most satisfactory. If the wire used is too small not only will its resistance be too high for most efficient results, but the small diameter of the wire will facilitate the deleterious short-circuiting of adjacent turns by the slider.

The slider usually consists of a small piece of spring brass or copper soldered to a short piece of square brass tubing, about three-fourths to an inch in length. A moulded knob of insulating material is fastened to the opposite side of the brass tubing, and the whole slides along a square brass rod slightly smaller than the inside dimensions of the tubing. The detail of the slider construction is shown in Fig. 27.

Tuning coils are usually made from 6 to 10 in. in length and from 2 to 4 in. in diameter. Occasionally, they are wound with bare copper wire and thread, the thread serving to insulate adjacent turns from each other. Such practice obviates the necessity of scraping the insulation off the wire in order that the slider may make contact with it.

In Fig. 26, the antenna circuit is tuned by means of the slider. This circuit consists of the antenna, that portion of the inductance,  $L$ , which is included between the antenna and the slider, and the ground. The secondary or detector circuit consists of the same amount of inductance, the detector, and the parallel combination of stopping condenser and telephone receivers.

The secondary circuit is called an *untuned secondary*, since no means is provided for tuning it to the incoming wave. The wavelength of the antenna circuit will always be greater than that of the secondary because of the additional inherent capacity and inductance of the elevated antenna itself. Only that portion of the inductance,  $L$ , which is included in the antenna circuit as a

means of varying its wavelength is common to both circuits.

In the third assignment, we learned that the current in a radio circuit "will not oscillate if the resistance of the circuit,  $R$ , in Fig. 8, is greater than a certain value, just as the pendulum will not oscillate if it is immersed in a very heavy liquid." In Fig. 26, unless a very large amount of the inductance,  $L$ , is in use (for receiving very long wavelengths the resistance of the detector,  $D$ , is too high to permit the detector circuit to oscillate. This means that the secondary or detector circuit is really a non-oscillatory circuit. The result is that it has no frequency of its own,

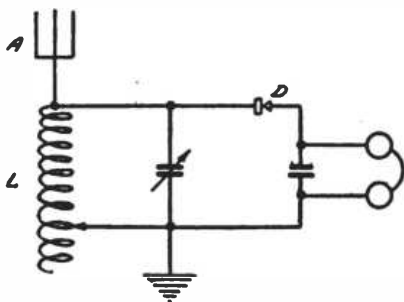

FIG 28

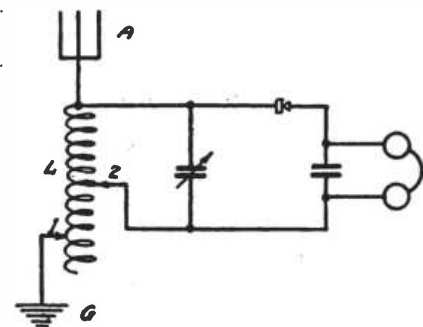

FIG 29

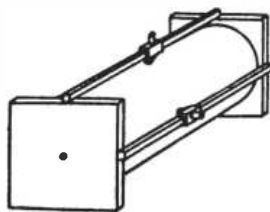

FIG 30

Fig. 28. Inductance Shunted by Variable Condenser.

Fig. 29. Circuit with Double Slide Tuning Coil.

Fig. 30. Typical Two-Slide Tuner.

since it cannot vibrate, so it responds equally well to waves or electrical currents of any frequency. In tuning the receiver shown in Fig. 26, therefore, it is only necessary to run the slider up and down on the tuning coil until the signals, voice, or music are heard the loudest.

If we shunt the inductance with a variable condenser, as shown in Fig. 28, we shall have provided means for tuning the secondary circuit, since the secondary circuit now consists of the active portion of the inductance,  $L$ , and the variable condenser. The detector is thus removed from both the primary and the secondary circuits, and we have two oscillating circuits, both of which must be tuned to resonance with the incoming wave and with each other. This circuit is similar to Fig. 22 of the last assignment except that the primary and sec-

ondary circuits are directly or conductively coupled to each other. (See definition of *auto-transformer* in the first part of this assignment.)

The circuit shown in Fig. 28 may be still further improved by the use of a double slide tuning coil, connected as shown in Fig. 29.

It has been found that the more turns of the inductance,  $L$ , which are used in, or are common to, both primary and secondary circuits, the broader is the tuning. This is because of the fact that as we increase the number of turns common to both circuits, we either increase the number of turns of the secondary threaded by the magnetic field of the

primary or else we increase the number of turns of the primary generating the magnetic field which intersects the secondary. Since the potential induced across the secondary depends upon the strength of the magnetic field within it and the number of turns comprising it, we are extracting energy from the primary at a more rapid rate with an increased number of turns common to both circuits—or with *close coupling*, as we say—than when the circuits are loosely coupled, i.e., with only a few turns, if any, common to both primary and secondary.

The energy which is extracted from the primary circuit by the secondary, as far as its effect on the primary is concerned, may be likened to energy wasted in resistance in the primary or antenna circuit. In other words, it tends to in-

Continued on page 78

# The Professional Radio Operator

By Volney G. Mathison

(Continued)

*In following the long road leading to the operator's first ship the ambitious reader will here find a guide as to wireless schools, correspondence courses, and license examinations. While "there is no royal road to knowledge," a few sign posts help greatly. These the author points out from the abundance of his personal experience.*

## THE WIRELESS SCHOOL

WHILE the operation of an amateur wireless outfit and diligent home study has in not a few cases sufficed in the obtaining of a commercial radio operator's license, the student should, if at all possible, plan to attend a good wireless school for a short time before essaying the government examination. If by book study he has imbibed the theory of radio and has gained a fairly comprehensive understanding of the general construction of radio equipment, in the wireless school he has an opportunity actually to operate the various types of apparatus about which he has read; he is enabled to acquire a familiarity with the instruments which only a practical demonstration of them can bring. In the school, too, he may have any desired amount of fast receiving drill that will prepare him to face with confidence the dreaded session at the test table of the government radio inspector.

In choosing a wireless school, the student should try to make sure that he selects a real school and not some sort of a semi-amateur establishment. Of the many so-called wireless schools scattered throughout the country not all are first class in the matter of instructors and equipment — especially the latter. There should be at least one complete installation of modern quenched-spark transmitting equipment; and the better schools have several. Aside from code practice, the student is wasting his time in a place where instead of finding the latest types of standard-make commercial equipment, he is introduced to a haphazard conglomeration of amateur apparatus such as he already has plenty of in his own wood-shed, or to some sort of antiquated straight-gap outfit of the type that Herr Hertz used in his experiments with oscillatory discharges of electric currents forty-two years ago.

The sort of instructors employed in a wireless school is also an important thing to determine as far as possible before enrolling. I once visited a widely advertised wireless school which I found to be in charge of a land-wire operator who could not send two lines of practice matter in the Continental code without slipping in half-a-dozen Morse letters; and who knew less about the technical side of radio than some of his students. I was informed by the manager of the school that a "radio expert"

came to the place three times a week to give technical instruction. If the radio expert was in keeping with the school and its equipment, he must have been some young operator with a second-class license—or perhaps none at all.

If the student wishes to learn to operate arc equipment, he should not fail to select a school that has a modern

movably around ten to sixteen words a minute no matter how long they practice. The layman, that is to say, one who has knowledge neither of telegraphic code nor of radio equipment, should plan to attend a good wireless school from six to twelve months to qualify for a first grade commercial operator's license.

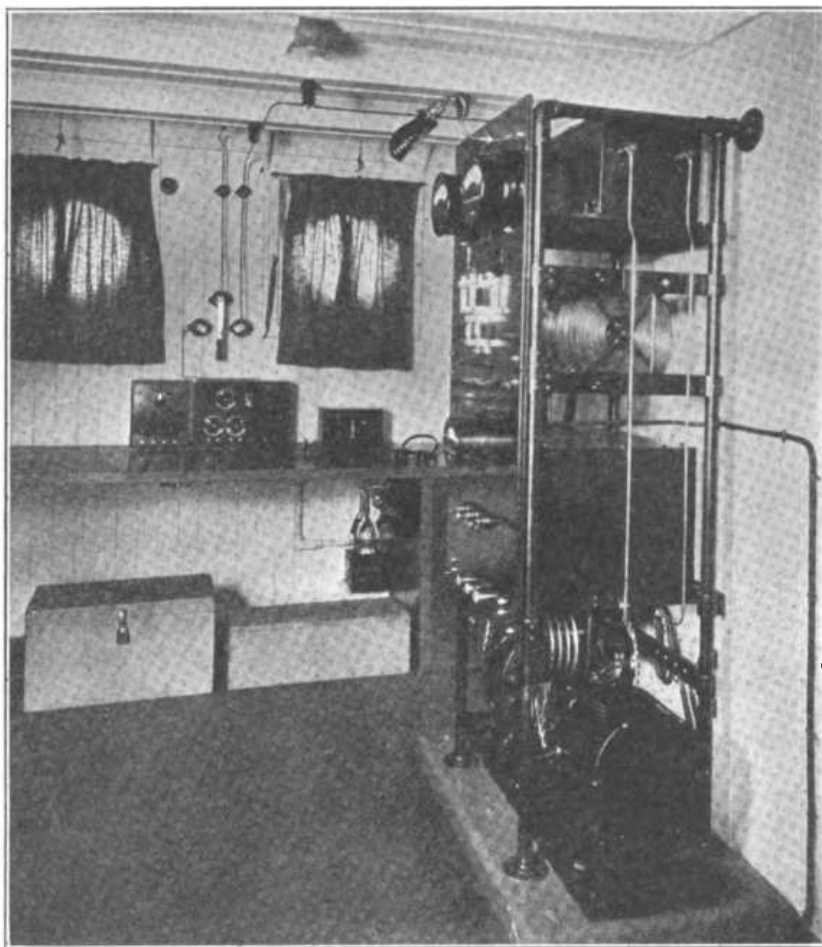

2 K.W. Set on Tanker "Frank G. Drum"

shipboard arc installation and commercial types of undamped receiving apparatus. No practical handling of an arc set, nor indeed of any other set, can be taught entirely on paper.

As to the length of time it will be necessary for the student to attend the wireless school, this depends chiefly upon the amount of preliminary training he has been able to give himself at home. Some learners with a remarkable aptitude for Continental code attain a speed of twenty words a minute in five or six months, while others again never do get that high, but seem to stick irre-

The well-experienced amateur, on the other hand, who has operated and experimented with his own outfit at home for two or three years, and who has studied with fair diligence in the meantime, may need to go to school only six or eight weeks—just long enough to familiarize himself with commercial radio equipment and to get a brief intensive brushing up on code receiving and general radio knowledge.

A typical radio amateur with a shack full of wireless junk, I went to school twelve days before going up for the government examination. While I got

away with a license, it was by a margin so narrow that I almost shudder yet at the memory of it. I really had intended to go to school longer—but that is a story. It is to be remembered, too, that the commercial operator examinations are a great deal more difficult now than they used to be.

#### WIRELESS CORRESPONDENCE SCHOOLS

Several correspondence school courses in wireless operating have been extensively advertised during the last few years. When these courses first came out, a number of gross misstatements were made in connection with them,

It may be said truthfully, however, that the correspondence school wireless courses at present on the market are well prepared and strictly up to date; and they are undoubtedly of value if studied in conjunction with the operation of an amateur radio set.

#### GETTING THE LICENSE

Passing from the stage of preparatory experimentation with the amateur set or training at the wireless school practice-table, we come now to a brief discussion of what is to many timid young minds—though not justifiably so—the supremely dreaded ordeal in the

1. A diagram (wiring hookup) of a complete modern commercial transmitting and receiving equipment, including emergency battery connections and charging panel .....	10
2. Knowledge of motors and generators, both direct and alternating.....	10
3. Knowledge of commercial transmitting apparatus (Theoretical principles, construction, practical operation, and maintenance) .....	20
4. Knowledge of receiving apparatus. Includes questions about the audion detector .....	20
5. Knowledge of storage battery construction and maintenance.....	10
6. Knowledge of the United States radio laws and regulations, international abbreviations, and naval regulations.....	10
7. Previous radio operating experience..	20

Total..... 100

About five points are usually allowed under "operating experience" for two or three years of amateur experience, or for wireless school training. The highest grade that the applicant can make, therefore, is 85; and since 75 is the minimum passing mark for the first class license, it will be seen that the candidate must have his technical knowledge pretty well in hand to get by successfully.

It is important to answer all the test questions precisely. In the course of an examination for an extra first class license, I found this among the questions on transmitting apparatus: "What does a condenser consist of?—or something to that effect. In answer, I wrote out quite a lengthy treatise, describing in detail every kind of condenser used in radio work that I had ever heard of,—Leyden jar, oil, mica dielectric, compressed air, open rack, paraffine paper, and, for good measure, three types of receiving variables. The answer complete filled five typewritten pages.

When the radio inspector checked my examination papers, however, he nicked half a point from a possible total of two points allowable for a satisfactory answer to the question about condensers. Wondering at this, I ventured to ask the inspector what flaw he had found in my 1500-word essay on condensers; to which he replied: "You didn't answer the question in the right way; you should have said simply that a condenser consists of two conducting surfaces separated by an insulating medium of sufficient dielectric strength to withstand such potentials as may be applied to it." Although I said nothing, I thought a few things, as may be imagined. I emerged from the examination with a grade of 98, however; and so I am sure that in the long run the radio inspector gave me a good deal.

In the radio inspectors' offices, the entire examination is written; there are no oral questions. It has, however, been a practice in the past in some of the navy yards where license examinations

*Continued on page 60*

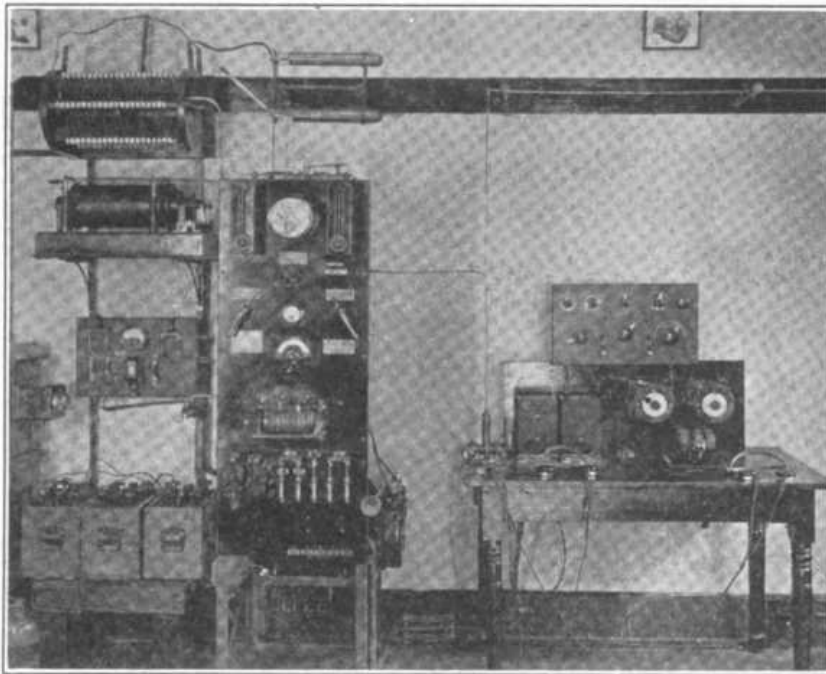

*Radio School Apparatus*

such as the assertion that anyone could become a radio operator in six weeks by studying a correspondence course by mail; and that upon obtaining a commercial radio operator's license, the correspondence school graduate could immediately secure a position at a salary of two hundred dollars a month or more—mostly more.

No training on earth will make a radio operator out of a raw beginner in six weeks—though a few students have managed to obtain first class licenses in six months. They were still far from being operators, however. As has already been stated, the highest salary that ever was paid to any prevailing extent for straight wireless operating on shipboard was \$125 a month (this was for only a short time), and, although the maintenance furnished the radio operator aboard ship is worth a good deal, still it is not cold cash. Most of the lurid correspondence school advertising has been pretty well toned down lately, for which we are all grateful; but it did harm enough before it was discontinued.

process of becoming a radio operator: the governmental license examinations.

In the limited space available here, only the examination for the first class commercial license can be discussed, for this is the license that the prospective operator is interested in. During the war when any sort of radio operators were at a premium, a few youths with second grade licenses got away to sea; but under present conditions, with quite a number of first-rate operators idling ashore, the beginner with a "pink ticket" had as well aspire to be elected president of China.

As is pretty generally understood, the examination for the first class commercial license, as indeed for all operators' licenses except the second grade amateur, is in two parts: first, the code tests, sending and receiving; and second, a review of the candidate's technical radio knowledge.

The technical examination comprises seven subdivisions, to each of which are allotted varying point values, arranged to total in all 100, as follows:



# The Code and Its Difficulties

By Carlos S. Mundt

*The romance of radio lies not in the radiophone concert but in the "dah dit" of the code messages whose staccato notes so bewilder the novice. To learn the code requires patience to the nth degree, but, once mastered, a new world is opened up to the listener-in. These suggestions from a practical teacher should prove most helpful to the beginner.*

**B**OTH wire and radio telegraphy may be defined as means of transmitting intelligence by means of a pre-arranged code, each letter and number of which is made up of a combination of the two radio code elements, the dot and the dash. The dot is caused by depressing the signalling key for an instant, while the dash is made by holding the key down somewhat longer, usually for three times the length of a dot.

The code in practically universal use in radio work is the "Continental" or "International Morse" as distinguished from that used in wire telegraphy, the Morse. Although slightly slower, the Continental has for its basis all distinct combinations of dot and dash inclusive of four elements in the case of letters, and of five elements in the case of numbers, the space being reserved as a separation element. Here is the Continental Code arranged according to *classified* formations:

<b>GROUP I</b> (Dots only)	<b>GROUP II</b> (Dashes only)
- E	- T
-- I	-- M
--- S	--- O
---- H	---- 0
----- 5	----- 0
<b>GROUP III</b> EQUALS REVERSED	
<i>Dot Beginning</i>	<i>Dash Beginning</i>
-- A	-- N
--- W	--- G
--- J	--- 9
--- 1	--- D
--- U	--- B
--- V	--- 6
--- 4	--- K
--- R	--- X
--- P	
<b>GROUP IV</b> Mixed Fours	
--- F	--- L
--- Y	--- Q
--- Z	--- *
--- C	
<b>GROUP V</b> Mixed Fives	
--- 2	--- 8
--- 3	--- 7

\*Utilized in foreign language.

A careful count will show thirty-six separate combinations utilized for the twenty-six alphabetical letters plus the ten numerals.

Recognition of these code combinations must, in the case of both wire and radio telegraphy, be an oral rather than a visual process. The method of visual instruction has been given much prominence by educators during recent years. But, while admirably suited to certain educational instruction, it must of neces-

sity fail here because of the inherent dependence upon *sound* in telegraphy for the conveyance of intelligence. Hence we are forced to accept the oral method of instruction and to point out the principles involved, as well as to suggest any aids or short cuts which may lighten the task.

Various persons are susceptible to varying degrees of oral instruction. This is just as true in teaching a child to associate the sound of a word with the word as it is in teaching code. But

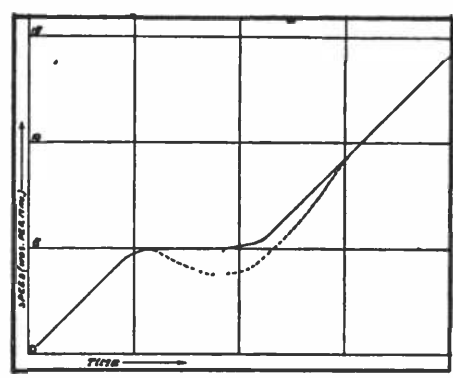

Fig. 1. Curve of Learning

we may tabulate statistical data on learning progress and attempt to draw conclusions from the graph resulting. Figure 1 is a fairly average portrayal of the analysis. We find the vertical axis scaled to represent the speed in words per minute, while the horizontal represents progressive time. A casual inspection of the curve will convince the reader of three outstanding facts, viz.:

(1) In the earlier stages of code learning there is fairly even and rapid progress; (2) After reaching a speed of from four to six words per minute (depending upon the individual) there is a retardation of progress, or even a retrogression (dotted); (3) After some time the early progress is resumed. Now, if we are able to put special effort and increased care on the difficult stage (that noted under (2), we may in a large measure make this stage at least shorter in duration.

The trouble noted in (2) is in all probability due to the time element entering into the motor response at that stage. The ear detects the sound, transfers the impulse to the brain, where it is analyzed by association. However, by the time such a speed has been reached as now considered (four to six words per minute) the motor response is increasingly difficult, due to the

character elements coming *faster and too fast for individual recognition*. Here for the first time the brain must *associate* "dah-dit with 'N' instead of saying "one dash and one dot makes N." All character combinations must be recognized each as a *sound group* belonging to a letter. "Sound swing" is difficult to define, but roughly it is the distinguishing sound sequence which makes "dah-dit" sound apart from "dit-dah."

We will now give suggestions for code work which are based upon the experiences of many and which are intended to lighten the task by avoiding unnecessary difficulties.

(1) Do not attempt the whole set of thirty-six characters at once. Rome was not built in a day, so they tell us. Neither was a whole code learned perfectly in a wholesale fashion. A good plan is to begin on the dot letters (group I) and the dash letters (group II). First try the groups separately to distinguish them among themselves. Then mix them, perhaps making simple words, such as the following:

HOT IS HIS MOS ITS SET SO  
TOM HIT MISS 5 TIES MET  
TIS. HE SHOT

(2) There is some disagreement as to what is the next step. Perhaps the safest thing would be to introduce additional characters only as fast as warranted. The easier ones of Group III ought to be brought in before any others. Group V can be well left until the last.

(3) Similar sound combinations, such as S, H and 5, often give continued trouble. Steady practise, first on them alone and later mixed with others, will help.

(4) Indeterminate dot letters, especially from the "equals reversed" often give trouble, the 4, V, 6, B, 7 and 3 being the worst offenders. Again, special practise with emphasis on the "sound swing" will help.

(5) Certain of the "equals reversed," such as W and G, give difficulty in a few cases. Treat as above.

(6) Mixed forms cause a great deal of trouble. Q, Y, F and L are examples. Treat as above.

(7) In addition, remember that receiving slightly *faster* than you are able means faster progress. Remember to practise sending to yourself, as this helps fix the characters in mind. Never work

Continued on page 64

# A Four Bulb Radiophone Transmitter

By Francis J. Andrews

**G**OOD results have been secured by the writer with four 5 watt tubes in a circuit adapted from one used by the U. S. Army during the war. When properly tuned it will transmit voice and music 100 miles or more.

The most important thing is the antenna system. No matter how efficient the transmitter may be, it is absolutely useless unless a proper antenna is used. For use with this transmitter, a "T" type antenna at least 40 feet high is recommended. The flat top should be 100 feet long with 2 feet spacing between wires. Seven strand phosphor bronze is recommended. Several water-pipes should be grounded together by means of a No. 4 stranded insulated wire. Also for the best results, a counter-poise should be erected directly under the antenna, a few feet from the ground. The counter-poise should be slightly larger than the antenna and thoroughly insulated from the ground and antenna. The lead-in from the counter-poise should be connected to the ground side of the set.

For lightning protection, the usual means of grounding an antenna should be employed, and a vacuum tube arrester and a single pole, double throw, 600 volt, 100 ampere switch should be used.

## LIST OF MATERIAL FOR THE CONSTRUCTION OF THIS SET

- 1 oscillation transformer, approximately 25 turns.
- 1 antenna ammeter, thermo-couple type, 0 to 3 amperes.
- 1 voltmeter, 0 to 500 volts, d.c.
- 1 voltmeter, 0 to 15 volts, d.c.
- 1 ammeter, 0 to 12 amperes, d.c.
- 1 milliammeter, 0 to 300 milliamperes, d.c.
- 1 variable condenser, .002 mf.
- 2 C. W. transmitting condensers, .002 mf.
- 1 C. W. transmitting condenser, .1 mf.
- 1 grid leak, 10,000 ohms.
- 1 plate circuit reactor or choke, 300 milliamperes.
- 1 honeycomb coil, L 50.
- 1 microphone, ½ ampere capacity.
- 4 dry cells.
- 1 potentiometer, A battery type, 300 ohms.
- 1 B battery, 22½ volts.
- 1 motor generator, 500 V d.c., 50 watts.
- 4 rheostats, 4 amperes capacity.
- 4 vacuum tube receptacles.
- 4 five-watt vacuum tubes.
- 1 12-volt storage battery.

Either a panel of bakelite or well seasoned wood, 18 in. by 30 in., may be used. The instruments should be connected up according to the diagram. The arrangement of the instruments on the panel is left to the taste of the builder. Remember that in laying them out on the panel, care should be taken to see that the instruments are so located as to make only a minimum amount of connecting wires necessary. No. 12 soft drawn copper wire and spaghetti insulation is preferably used and all connections must be soldered.

## How to Tune the Transmitter.

1. Light the oscillator tubes until the ammeter registers  $4\frac{1}{2}$  amperes, and the small voltmeter shows  $7\frac{1}{2}$  volts.
2. Start the motor generator and wait until it builds up to 500 volts.
3. Fix the tap leading from the plates to the oscillation transformer at some point on the oscillation transformer. Then vary the antenna tap, and vary the

## V. T.s FOR TRANS-ATLANTIC TELEGRAPHY

An experimental, high-powered tube set at Radio Central, Rocky Point, L. I., is handling commercial trans-Atlantic traffic with Great Britain and Germany, on a wavelength of 19,000 meters. The set is, for the time being, composed of three 50 kilowatt, 15,000 volt, water cooled, metal kenetrons, used as rectifiers, and six 15,000 volt, 20 kilowatt, water cooled, metal pliatrons, used as high-frequency converters. For the experiment with the tube set one of

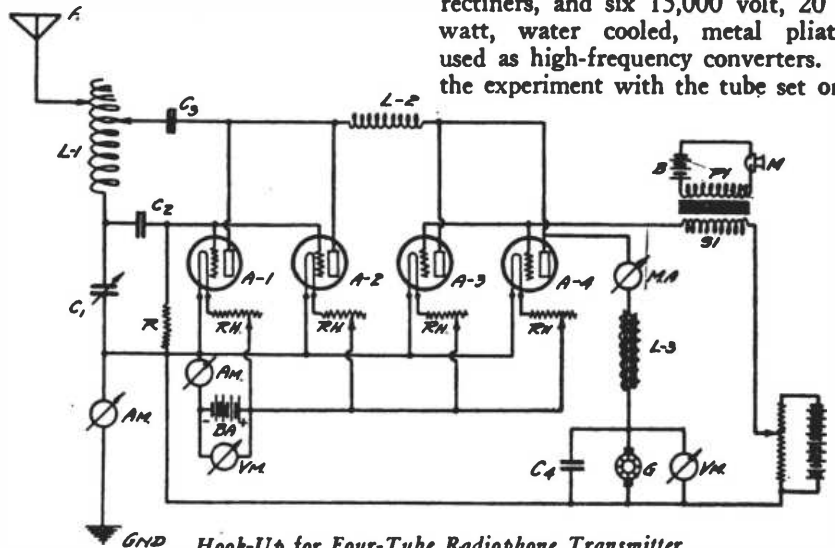

plate tap until the antenna ammeter and milliammeter read maximum current. The variable condenser should also be varied to obtain maximum antenna current.

4. Light the filaments of the modulator tubes, until the ammeter shows  $9\frac{1}{4}$  amperes and the small voltmeter remains fixed at  $7\frac{1}{2}$  volts.

5. Retune the plate and antenna circuits for maximum current.

6. Speak into the microphone and at the same time vary the potentiometer and note when the greatest deflection of the milliammeter and antenna ammeter takes place. Then leave the potentiometer on this adjustment.

Note: It would be well to have another operator listen-in while you are tuning up the set and inform you as to the quality of the transmitted speech.

## URUGUAY PASSES FAVORABLE RADIO LEGISLATION

Recent modification of the rigid laws governing the installation of wireless telephone and telegraph stations have made possible the installation of radio broadcasting, according to Vice Consul Edwin B. Montgomery of Montevideo. Applications are now pending which, if granted, should mean the opening of a splendid market for radio telephone receiving apparatus in Uruguay.

the new mile and a half long antennae suspended from six towers, 426 feet high, of the Rocky Point Station, was used, and the tube set succeeded in developing and sustaining in the antennae a current strength of 350 amperes.

So successful was the set in the initial experiment that the operators controlling the automatic sending keys at 64 Broad Street in New York City did not know that they were controlling a tube transmitter rather than an alternator until after the test was completed.

The Radio Corporation also announces a service which enables the public to send messages to London and Germany at a rate slightly higher than postage. The rate announced is six cents per word with no minimum requirement. It will be possible hereafter for individuals and business houses to send messages of as few words as three or four at the fixed rate of six cents for each word, as for instance, "All well" would cost only twelve cents plus charges for address, and signature, if any. A message may be filed any day in the week up to Saturday with the designation "Radioletter" or its abbreviation "RL" and it will be transmitted in time to reach London or Germany the following Monday morning. While registered code addresses are acceptable, the text of the message is restricted to plain language only. The new service is called the "Radioletter Service."

# Simplified Theory of the Federal Arc Transmitter

By V. Ford Greaves, Engineer Federal Telegraph Company

**S**OUND, light and radio telegraph signals are carried by means of waves which, for purposes of general illustration may be represented by simple diagrams. Waves are divided into two classes, called "damped" and "undamped."

Damped waves are those which, once started, either quickly or gradually decrease in size or amplitude until they die out entirely. When the head of a drum is struck all that is heard is a thump. The sound waves quickly fade away and are therefore called highly damped. On the other hand, when a tuning fork or piano-string is struck, a musical tone is heard which gradually dies out. Such waves are said to be slightly damped. Another analogy is that of the child in the swing. If the swing is pulled back once and then permitted to "die out," the oscillations will gradually decrease until the swing comes to rest. Such oscillations would be classified as slightly damped.

Undamped waves are those which are maintained in size or amplitude and are sometimes called continuous. Light waves are continuous or undamped. When the string of a violin is uniformly rubbed with a bow, a clear musical tone is heard, which does not fade away as in the case of the piano-string. Instruments similar to the violin, and wind instruments, produce undamped waves. Now coming back to the child in the swing, we all know that if a second person stands behind the swing and gives it a push each time it comes back, the swing will continue to oscillate at its maximum amplitude. In this case these continuous oscillations would be classified as sustained or undamped. In music, as in radio telegraphy, sustained or undamped waves are recognized as being superior to damped waves, for one reason among others, that they have better carrying qualities.

Spark transmitters produce damped waves, while the Federal arc is a generator of continuous or undamped oscillations. In addition to this advantage, the arc transmitter is much more simple in construction and operation. These differences in the characteristics of waves and electrical circuits are clearly shown in the accompanying diagram.

The spark transmitter consists of the following main units:

- S A source of low voltage alternating current.
- T A transformer for increasing the voltage.
- C A condenser for producing damped oscillations.
- SG A spark-gap for the condenser to discharge across.

OT An oscillation transformer so that the oscillations in  $L_1$  can be transferred to the antenna through  $L_2$ .

A The antenna.

G The ground connection.

The Federal arc transmitter consists of the following main units:

S A source of direct current of low voltage.

CC Choke coils or inductances.

R Resistance.

ARC The arc.

L An inductance for changing the wavelength.

A The antenna.

G The ground connection.

two methods of swinging the child, one inefficient and round-about, and the other efficient and business-like. In the first case, which we will compare to the spark transmitter, the person gives the swing a push and then sits down until the swing comes almost to a stop. He then jumps up and gives the swing another push, and so on. In the second case, representing the arc transmitter, the person stands firmly behind the swing and gives it a push each and every time it comes back.

Alternating current is used as a primary source of power in spark transmitters for the reason that it is more satisfactory from an engineering point of view, than direct current interrupted, although direct current can be used. Direct current flows or pushes in one direction only when it is moving. Direct current does not necessarily flow continuously, as is sometimes thought, but can be stopped and started at will.

Our analogy of the swing can be used to illustrate how the Federal arc changes direct current to alternating current in such a simple manner if we consider the case where the person pushes the swing each time it comes back. The swing oscillates forward and backward from its normal position of rest. These oscillations or alternations may be taken to represent an alternating current of electricity. The person pushing the swing always pushes forward when the swing is traveling forward; it coming back of its own accord. Therefore, the person may be taken to represent an interrupted direct current, always pushing in the same direction at intervals. So it is with the arc. The direct current is interrupted by the action of the arc in exact time with the alternating current in the antenna and every other alternation is given a push of just the right amount and at just the right time to keep the oscillations going to full amplitude and we get undamped waves.

We shall now consider what takes place within the circuits of a Federal arc converter. The phenomena is, of course, almost instantaneous, but in order to analyze the various relationships they must be treated as occurring very slowly. It will be understood that the antenna and ground are equivalent to inductance and capacity in series forming the well-known "dummy antenna." Therefore, for the purpose of this explanation, we will substitute an inductor and condenser in series across the arc in place of the antenna and ground connections.

First consider the simple arc circuit alone without the inductor and condenser being connected. The direct

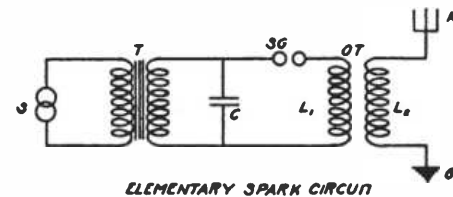

ELEMENTARY SPARK CIRCUIT

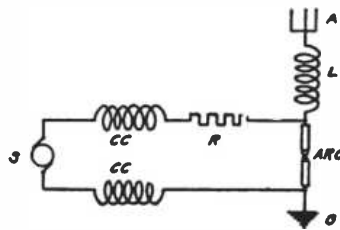

ELEMENTARY ARC CIRCUIT

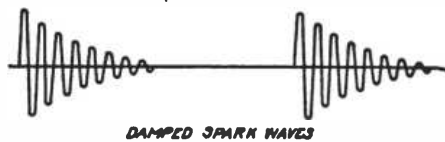

DAMPED SPARK WAVES

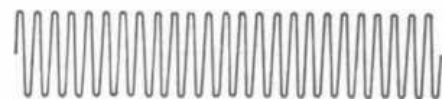

UNDAMPED FEDERAL ARC WAVES

### Characteristic Waves and Electrical Circuits

The typical spark transmitter starts with low voltage alternating current. The voltage is then increased by means of a low-frequency transformer. The high voltage charges the condenser, which in discharging across the spark-gap through the inductance  $L_1$ , produces a high frequency alternating current, the oscillations of which, however, are damped. Then, by means of the oscillation transformer, an alternating current of high frequency is set up in the antenna circuit, a part of which is radiated in the form of damped waves.

The Federal arc transmitter starts with a low voltage direct current and produces a high voltage alternating current directly in the antenna circuit, a part of which is radiated in the form of undamped or continuous waves.

Considering again the analogy of the swing, the difference between spark and arc transmitters can be illustrated by

# Radio in Australia

By L. S. Lane

current from the primary source flows across the arc in one direction and maintains a steady flame as long as the current is uniformly applied. The resistance of the arc varies if the flow of current is varied. Increasing the current decreases the resistance, and *vice-versa*. Now, referring to Ohm's law, it will be seen that the voltage, measured across the arc, will also vary if the flow of current is increased or decreased. Therefore, it may be stated that the voltage across the arc varies inversely as the current, or in other words, if the current is decreased from any cause the voltage will increase and *vice-versa*. Having this law firmly in mind, we will now connect the inductor-condenser circuit across the arc.

Immediately the direct current from the primary source will start to flow in this new circuit in an effort to charge the condenser. It can readily be seen that this amount of current will be subtracted from the arc circuit with the result that the voltage across the arc is increased, which causes more current to flow in the condenser circuit and so on, until the condenser is overcharged, due to the inductance of the circuit, which phenomenon is similar to inertia of solids in motion.

The condenser now discharges in the reverse direction across the arc in the direction of the arc current and again overcharges the condenser in the opposite direction, due to inertia. The next condenser discharge is then in a direction opposed to the local arc current, with the result that when the opposed currents become equal in value the arc is extinguished and de-ionized by the magnetic field. The condenser discharges and is again recharged by the supply current to the point where the voltage is sufficient to reignite the arc and the cycle of operations is repeated. This phenomenon, when established, results in a smooth alternating current in the output circuit having a frequency dependent upon the values of the inductance and capacity employed.

Metallic substances, when heated, give off a metallic vapor containing ions. Soft substances, such as copper, carbon and zinc, under the intense heat of an electric arc, release a great number of ions, so that the space or gap between the terminals is heavily ionized. Any space or gas which is heavily ionized becomes a low resistance conductor of electric current. Ionized gas is very sensitive to the influence of a magnetic field.

It has been stated that the arc terminals are placed in a strong transverse magnetic field, that is, magnetic lines of force are set up at right angles to the flow of current and ions across the arc. This magnetic field assists in extinguishing the arc quickly and restoring high resistance across the gap by throwing the ions out of the arc path,

THE radio fan in Australia is faced with regulation which, when compared with those of America, are almost prohibitive. Despite official setbacks, however, there are several radio clubs and a small number of transmitting sets, both radiophone and telegraph, in operation.

To erect a receiving set, crystal only, it is necessary to obtain a license. This costs the equivalent of \$5.00. If a valve receiving set is desired, the same fee applies, but in addition it is necessary for the amateur to pass a receiving test of twelve words per minute. Transmitting permits are rarely issued to individuals, only about 12 transmitting licenses having been issued to individual amateurs in the whole of Australia. On the other hand, radio clubs have little difficulty in obtaining these much sought after documents, nearly every club having one.

Radio broadcasting is just becoming popular in Australia, though at present there are only two stations giving regu-

lar programs, and in each case only once a week. As regards broadcasting waves, conditions are superior to those ruling in the United States; the waves in use at present are 1100 and 1400 meters. The radio clubs are, however, usually confined to the 200 meter wave. The power of amateur transmitters is limited to 250 watts.

lar programs, and in each case only once a week. As regards broadcasting waves, conditions are superior to those ruling in the United States; the waves in use at present are 1100 and 1400 meters. The radio clubs are, however, usually confined to the 200 meter wave. The power of amateur transmitters is limited to 250 watts.

There are several healthy indications that conditions are being improved, and irksome regulations relaxed. Recently

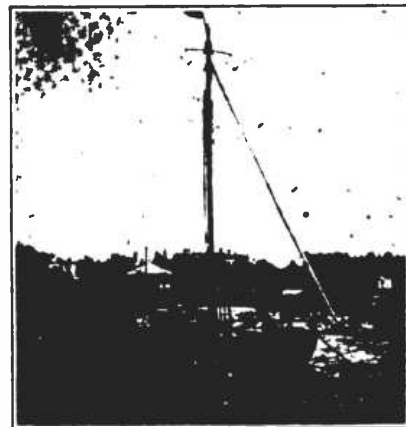

Radio Yacht "Kestrel"  
Moored at Williamstown, Victoria.

which allows the condenser or antenna circuit to become fully charged.

Referring again to the swing analogy, we know that the push on the swing must be delivered at the right moment and be of the proper duration. These conditions vary with different lengths of swings. It is the same with the arc. The arc must be extinguished at the proper moment and for the proper length of time, according to the wavelength. The wavelength corresponds to the length of the swing, therefore the strength of the magnetic field, and hence the speed of de-ionization must be varied with any change of wavelength. The magnetic field must be increased as the wavelength is decreased, in proper proportion to produce stable operation of the arc.

The arc terminals are surrounded by hydrogen gas to further assist in the de-ionizing process as the high velocity of the hydrogen ion assists the magnetic field. The hydrogen gas also helps in cooling the electrons by virtue of its high heat conductivity. The electrodes are further cooled by means of running water.

Under normal operation an ammeter in the alternating current or antenna circuit will indicate .707 times the ammeter reading in the direct current supply circuit. This ratio, namely  $\frac{1}{\sqrt{2}}$

also applies to the corresponding voltages resulting in a theoretical electrical efficiency of 50 per cent for a modern Federal arc converter. This efficiency is nearly realized in practice with large units.

the annual license fee was reduced from ten to five dollars. A semi-official promise has been made by the prime-minister that he will follow the lead of Great Britain, and make the obtaining of a license much easier. At present it takes about three months to obtain a license.

The newspapers and commercial firms are awakening to the possibilities of radio, and some are only awaiting official sanction before commencing the erection of broadcasting stations. A weekly magazine solely devoted to radio has made its debut and received a hearty welcome from the enthusiasts.

A Sydney amateur has succeeded in telephoning to New Zealand, a distance of about 1100 miles, using nine watts. This was received on a regenerative receiver using only one valve.

As regards developments in commercial radio, arrangements have been made by the Amalgamated Wireless, Ltd., for a vacuum tube station intended for direct communication between Australia and England. This distance of 12,000 miles will represent the longest commercial radio service in the world. Prior to the departure from Australia of the director of the company he agreed to write a series of articles for the *Sydney Daily Telegraph*. These articles were written on board the *Sophocles*, transmitted 500 miles by radio to Perth Station, and then mailed to Sydney, where they were duly published.

# A New Radio Frequency Amplifier

By E. M. Sargent

*This constitutes the entry winning the second prize in the radio frequency amplifier contest which closed October 15, 1922. It is followed by the third prize winner. The fourth prize winner will be published in January RADIO.*

A FEW of our eminent citizens at one time or another purchase the Statue of Liberty, the City Hall, or the Ferry Building; others chase the pot of gold at the end of the rainbow, while still others try to get results with a radio frequency amplifier. Your humble writer belongs to class three.

It was about three years ago that this marvelous, new cure-all for receiving trouble first attracted serious attention. If there were a spark coil transmitter in the house next to you and you wanted to receive through it, your local radio engineer would say—"Use radio frequency." If the mosquitoes got too thick and your pipe wouldn't keep them away,—put in radio frequency. No matter whether it was a grounded antenna, a run-down B battery, or ulceration of the wavelength,—"try radio frequency" never failed to inspire the poor victim with new hope.

The writer fell for this new myth along with everybody else, and sunk a good sized chunk of cold cash into apparatus to try it out. There is no need to detail here the building of that first outfit, to tell of connecting it to a loud speaker to prevent possible injury to the only pair of phones,—and to relate the "results" that were obtained. Suffice to say that it was only because of the size of the financial investment that experiments were continued along these lines, and that is probably the reason why it was finally discovered that when used properly radio frequency is a valuable asset to the long distance receiving amateur.

**WINNERS OF RADIO FREQUENCY AMPLIFIER CONTEST**  
**1st Prize—H. E. Parsons, Can. 5EH (Published in November RADIO).**  
**2nd Prize—E. M. Sargent, 6SC (Published in December RADIO).**  
**3rd Prize—W. J. O'Neill, 9CJX (Published in December RADIO).**  
**4th Prize—Robt. Kerrigan. Will be published in January RADIO.)**

deals only with specific cases in which certain distances have actually been covered, and the reader is left to draw his own comparisons with his receiving set and the results he gets.

## THE AMPLIFIER

What a radio frequency amplifier will not do:

1. It will not increase the strength of signals from nearby stations.
2. It will not, in itself, eliminate or reduce interference or static. On the contrary, when used with an overhead antenna, it usually increases both.

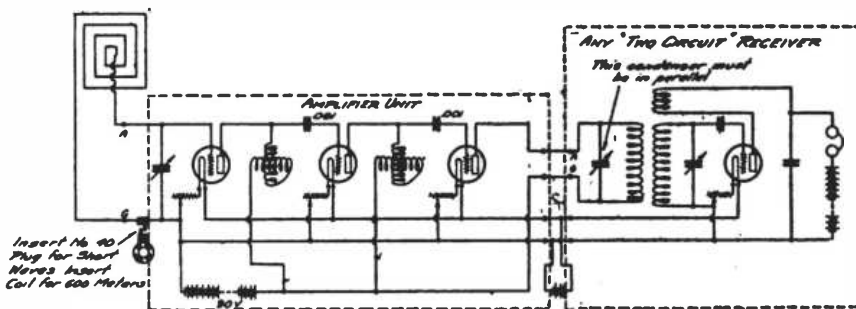

Fig. 1. Circuit Diagram for Radio Frequency Amplifier

- LIST OF MATERIAL**
- |                                      |                              |                           |
|--------------------------------------|------------------------------|---------------------------|
| 3 Paragon Sockets                    | 2 .001 mfd. Fixed Condensers | 1 Penn 23-plate Condenser |
| 3 Paragon Rheostats                  | 3 C-301 Amplifiers           | 2 45-Volt "B" Batteries   |
| 1 No. 40 Coil Plug (short circuited) | 2 Cymo Variometers           | 1 No. 42 Panel Plug       |
|                                      |                              | 1 50-Turn Honeycomb       |

At one time or another, the writer has tried nearly every known form of radio frequency amplification. The set about which this article is written is the one that has proven to be the best of all that were tried. The article

What a radio frequency amplifier will do:

1. It will increase the strength of signals from distant stations and will also increase both the day and night distance over which signals can be received.
2. It will permit the amplification of weak or moderate signals with no corresponding amplification of tube noises.
3. It makes possible the use of loops and other directional antennae which greatly reduce static and interference.
4. It prevents the regenerative receiver with which it is used from radiating any energy out into space through the antenna. This energy radiation from receiving sets is a troublesome problem in many of our cities and the radio frequency amplifier offers a possible solution.

Fig. 1 shows the circuit of the amplifier. Notice that the amplifier can be used with any "two circuit" regenerative or non-regenerative receiver. It is only

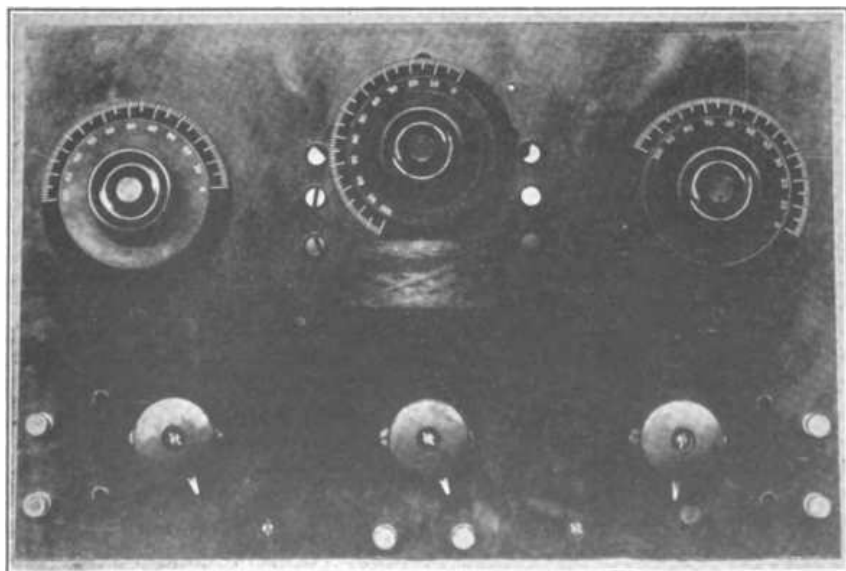

Radio Frequency Amplifier Panel

necessary to change the primary condenser of the receiving set from series to parallel. Variometers are used for radio frequency amplifying transformers. This does away with the necessity for a potentiometer and allows adjustment for maximum signal strength for each wavelength. The two grid condensers are to keep the plate voltage off the grids. They should be .001 mfd. or larger. The use of grid leaks is optional, none being shown in the diagram. The honeycomb coil is for loading the loop to 600 meters. This should be short-circuited for operation on the lower wavelengths.

The amplifier can be used with an overhead antenna, although this is a doubtful advantage. The antenna and ground are connected in place of the loop and the proper honeycomb coil in-

receiver operated independently over a small band of wavelengths. This feature greatly simplifies the operation of the set. The amplifier can be calibrated for different wavelengths, and after it has been set for a wave, the regenerative receiver is tuned exactly as if it were directly connected to the antenna.

Care must be taken that the amplifier tubes are not allowed to oscillate. If the variometers are turned too far there will be a click, after which the set will suddenly be silent. The click indicates that one of the amplifier tubes is oscillating, and the oscillations are being amplified to such an extent that they paralyze the detector. The best setting for the variometers and also for the condenser around the primary of the regenerative receiver, is just before this click. It will be found a great advantage to shield both the amplifier and the

Francisco. This station was four miles due east of the receiving station. Signals from this station were completely eliminated and KOG and KUY in Los Angeles picked up.

The selectivity of the loop seemed confined almost entirely to phone and C. W. signals. On sparks, while the signal strength varied a good deal with different positions, no position was found that would completely cut out any of them. Between the hours of 2:00 and 4:00 a.m. recently, the following stations were copied with the loop on 600 meters. No audio amplification was used:

VAE—Pt. Estevan, B. C.; 800 miles—strong.  
 NPD—Tatoosh, Wash.; 750 miles—strong.  
 KOK—San Pedro, Cal.; 370 miles—strong.  
 NPQ—St. Paul, Alaska; 2400 miles—good.  
 KHK—Hawaiian Islands; 2100 miles—weak.  
 NPM—Hawaiian Islands; 2100 miles—fair.  
 JOC—Ochishi, Japan; 5100 miles—weak.  
 JCS—Choshi, Japan; 5200 miles—good.  
 Two boats in Alaska waters—2000 miles—strong.  
 One boat off Central America—1700 miles—fair.  
 Two boats off Japan—4500 miles—strong.

Had the radio amplifier been connected to an antenna, the signals would have been many times louder and, interference and static permitting, would have been received with greater audibility than on a detector and three-stage audio amplifier. In this circuit, the tube is more efficient as a radio than as an audio amplifier.

### WINNER OF THIRD PRIZE

By WILLIAM O'NEILL

The construction and operation of a radio frequency amplifier presents many new features to the average amateur, who, although he has many circuits, etc., for—r.f. has not the firsthand information available about construction and operation. The set described is my idea of the best all-around type that I have had experience with.

It has a minimum number of parts and variable controls which means simplicity and economy and gives maximum amplification per stage, (about twice that of either an untuned air core or an untuned iron core transformer). In regard to simplicity I might say here that if more than two stages are employed the coupling impedances may be mounted on the same shaft or otherwise simultaneously controlled.

The set is a complete unit containing two tuned impedance direct coupled amplifiers and a detector. The antenna input can be taken directly in at the terminals of the tuning condenser of the first stage if desired, although a small coil in series with a large capacity condenser gives much better selectivity.

If a loop is used it should be made of sufficient inductance to dispense with

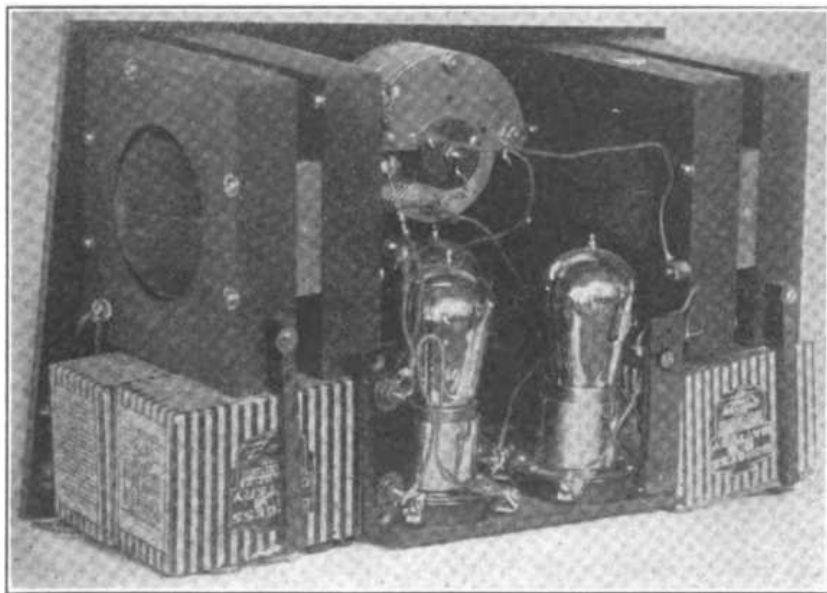

Rear View of Radio Frequency Amplifier

serted for the wavelength. When used in this way, 600 meter signals from distances of 500 miles or more will be amplified so much that they will "spill" the detector bulb. Consequently, the interference is so bad that this arrangement is of very little practical value.

### OPERATION

The operation of this outfit is remarkably simple, much more so than the diagram indicates. To receive a given wavelength, first tune the regenerative receiver secondary to the wave. This setting is usually known from experience. Then tune the receiver primary until a resonance click is heard. Next set the two variometers in similar positions and rotate both together until some signal is heard. Then adjust the variable condenser in the loop or antenna circuit for the loudest signal. After this, the exact positions of the two variometers can be found. When the amplifier has been adjusted in this way, it can be left alone and the regenerative

receiving set. The rheostats are not critical on any of the tubes.

This amplifier was given a thorough test with a loop 18 in. square, consisting of 16 turns. This was found to be about right for 360 meters. For 600 meters, a 50-turn honeycomb coil was connected in series. The regenerative receiver used was one that compared favorably with the Grebe CR-8. No audio amplification was used.

The receiving station was located in San Francisco. Between the hours of 8:00 and 8:30 p.m., the broadcasting station KLP at Los Altos, 30 miles south of San Francisco, was in operation. It was found that by setting the loop in the right position, this station could be entirely cut out and signals from KZN, in Salt Lake City, brought in with fair audibility. This is a distance of 800 miles, and is a feat in the elimination of interference that would be impossible on an overhead antenna. A little later in the evening, KLP gave way to KDN, Fairmont Hotel, San

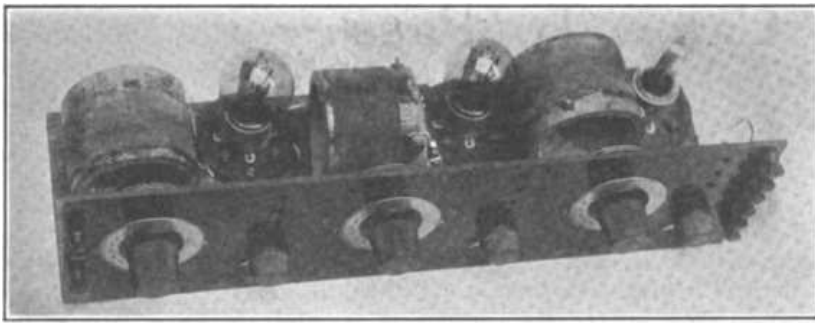

Radio Frequency Amplifier Built by W. J. O'Neill

the coil normally in shunt with the condenser.

Though unnecessary for code reception, care should be taken to operate the amplifiers at the middle of the straight part of the curve by using proper plate voltage if distortionless voice is expected.

With a single 200 ft. wire aerial I have used coupling of 1½ to 2 ft. with the primary and secondary at right angles, giving extremely fine tuning.

The apparatus may be built into a panel for use with a separate detector or built up on a board for experimental purposes if desired.

The circuit used has been found superior to several others, including the "semi-tuned" intervalve transformers, circuit in which inductive coupling is used between stages with either primary or secondary tuned. If both primary and secondary are tuned the same signal strength and better selectivity result, but the double number of controls necessary usually does not compensate for the advantages.

Tuning spark signals is similar to the familiar three-circuit regenerative set with the exception that all three dials must be set in approximately the same order to transfer through the successive stages. With C. W. the best notes are

produced by the autodyne action of either of the amplifiers. This is done by tuning the plate and grid circuits in the same manner as in the ordinary tuned plate sets.

The set is soldered throughout with No. 14 bare wire in order to reduce undesirable capacity effects.

From left to right, the instruments in the photo are: Aerial and ground binding posts; inductance in grid circuit of first tube; tuning condenser of same and amplifier tube. The next coil and tube are identical with the first, while the last is the detector. The row of posts are: 1 and 2-phones; 2-pos. amplifier battery; 3-pos. tap for soft detector; 4-potentiometer arm for grid bias control; 5 and 6-"A" battery; 6-negative "B" battery.

### RADIO BROADCASTING IN GREAT BRITAIN

"Great Britain will solve the interference problem in radiophone broadcasting by government control and regulation," according to A. P. M. Fleming, C. B. E., manager of the research and

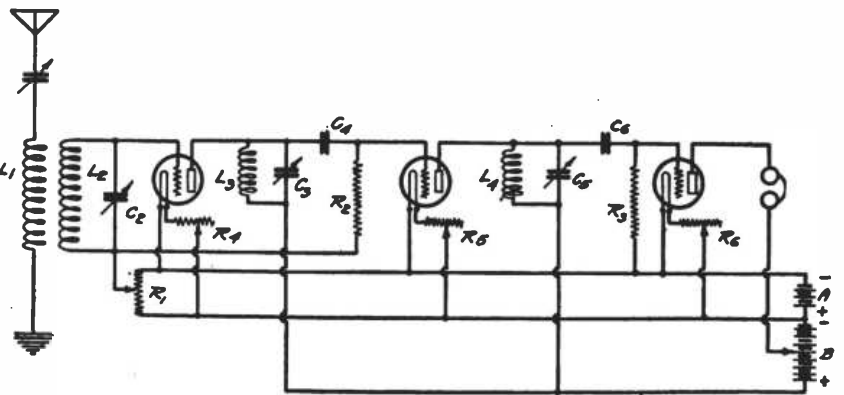

Diagram of Connections for Two-Stage R. F. Amplifier and Detector

C<sub>1</sub>—.001 mf. C<sub>2</sub>—.0008 mf. C<sub>3</sub>—.0008 mf. C<sub>4</sub>—.00019 mf. C<sub>5</sub>—.0008. C<sub>6</sub>—.00025. R<sub>1</sub>—200a. R<sub>2</sub>—1½ megohm. R<sub>3</sub>—½ megohm. R<sub>4</sub>—1½ w. R<sub>5</sub>—1½ w. R<sub>6</sub>—6 w. L<sub>1</sub>—40 turns No. 22 d.c.c. on 8-in. tube inside of L<sub>2</sub>. L<sub>2</sub>, L<sub>3</sub>, L<sub>4</sub>, L<sub>5</sub>—65 turns on 8½-in. wood form. Tapped at 40 and 50 turns.

As to the tubes used for radio frequency amplification A-P amplifiers and Myers and Western Electric VT-2s are best, though the latter are the more difficult to obtain.

educational department of the Metropolitan - Vickers Electrical Company, Manchester, England. Mr. Fleming represented England at the international convention of the Institute of Electrical Engineers and the International Electro-Technical commission at Niagara Falls, just ended.

"We have learned many valuable lessons from the broadcasting experience of the United States." One of the things we have learned is to avoid the establishment of innumerable radio stations, with no plan of co-operation between them. Eight 1½ kw. stations are contemplated and some of these will probably be built this year. These stations will be located in the principal cities throughout the British Isles and will be operated so as to eliminate the chaos usually found where no rules are in force.

"We have no such thing as broadcasting in Britain at present in the sense in which the term is used in America," he said. "Government restrictions have prevented it, on account of the possible interference with the requirements of the navy, mercantile, marine, war services and aeroplane

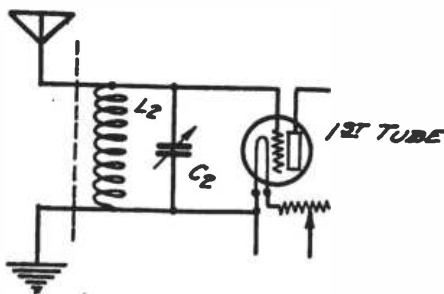

DIRECT CONNECTION TO AERIAL

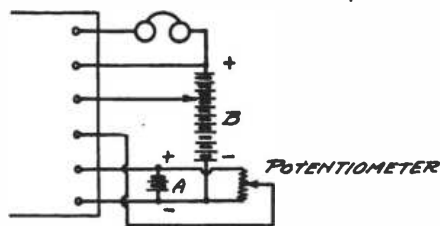

EXTERNAL CONNECTIONS

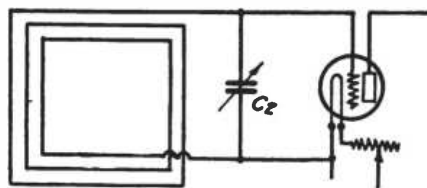

LOOP ANTENNA  
L<sub>2</sub> DISCONNECTED  
Methods of Connection

The following is a list of the materials and cost in this set:

Bakelite Panel—6 in. x 24 in. x 3/16 in.	\$ 2.50
Oak Base 7/8 in. x 6 in. x 24 in.	.30
8 Binding Posts	1.75
3 Fada Rheostats	3.60
3 Ga-std. Dials	3.75
3-13 Plate Condensers "Illinois"	6.30
3 Coils	.30
3 W. S. A. Co. Sockets	2.70
2 Grid Condensers—W. E. and GrebeROCB	1.75
2 Grid Leaks	2.00
1 Radio Corporation Potentiometer	2.00

Total.....\$27.05

Continued on page 98

# "And It Came To Pass---"

## Roundabout Remarks on Radio Remembrances

By Sewell Peaslee Wright

AND it came to pass that in the fullness of time the months wherein static, which is called "X" (and divers other things, though not in print or the presence of ladies!) becometh history, and the cold weather cometh on apace. And every ham, each unto himself, maketh mighty resolves regarding the work to be done this winter. But this merely lendeth atmosphere (saith thou not to thyself words of mockery concerning "hot air," thou who readeth!) to the tale; let us proceed henceforth to the point.

As soon as the first touch of cold weather cometh, a certain ham, who hath had long years of experience, starteth to till the soil for a Radio Christmas. He saith unto his dad that a pair of 5-watters would make a dandy Christmas present, and he letteth his mother know where one buyeth Baldwin phones. His rich uncle is told of the wonders of a Magnavox, and lo, he mentioneth its price, and enlargeth upon his longing therefor.

He telleth his brother frankly that he wisheth a new storage battery for Christmas, and he receiveth a wise smile, which he taketh for an affirmation. Sister he letteth know that his subscription to RADIO is about run out, and that a renewal would pleaseth him mightily. And he looketh over the territory, and he thinketh unto himself, I have missed not one! This Christmas will truly be a radio one, the like of which I have dreamed of for many years. And he rejoiceth exceedingly in the thot.

During the days that passeth when Fall turneth into Winter, and the Yuletide cometh on with a rapidity that scareth Dad's pocketbook into convulsions, and maketh the very small youngsters almost hold their breath in anticipation, he harpeth away on his desires at all times, saying such things as I am glad indeed that I am to get nothing but radio presents this year, and I sure will appreciate my presents this year! And he leaveth catalogs and dealer's ads around with cunning carelessness.

In the fullness of time it cometh to pass that the night before Christmas arriveth on the twenty-fourth of December, and our hero sitteth in front of the fireplace, rubbing his hands in anticipation of the radio Christmas which the next day was to usher in. He fixeth in his mind the words of thanks he will use in expressing his gratitude, and he sitteth there long, thinking kind and joyous thots.

And on the next morning, being Christmas, he ariseth early, yea, he even beateth the alarm clock's clarion

note, and he dresseth sketchily and rapidly, and departeth speedily to the lower regions, where he knoweth that his Christmas gifts will be displayed. He shouteth with much glee when the black horn of a Magnavox peepeth out from much tissue paper. He huggeth two 5-watters so tightly that he almost squeezeth the vacuum therefrom. He testeth the new storage battery, and its pep pleaseth him greatly. His Baldwin arouseth admiration and joy beyond expression—he was more than happy; he was fairly oscillating with very gladness. He hooketh the battery and phones and the Magnavox to his set, and turneth on the whole three steps. He picketh up a 'phone station sending chimes, and lo, the volume therefrom was so great that it shaketh the house——. He waketh with a start, as his mother taketh her hand from his shoulder and telleth him to listen to the midnight chimes from a nearby church. It taketh him minutes to realize that it hath all been but a phantasy of the night. He goeth to bed with a hopeful heart, but strange forebodings, for is it not written that dreams go by reverses?

And in the morning he ariseth, even as in his dream, and goeth down stairs likewise — but the likeness between dream and reality stoppeth there with much abruptness.

For when he openeth the packages bearing his name, he findeth that he hath received seven neckties, thirty handkerchiefs (twelve of which beareth his initial in pink silk) five pairs of slippers, Wells' History of the World, in two volumes, a combination garter and sleeve-band set, and fourteen pairs

of socks—each pair different in size and color.

YE scribe here draweth the curtain, for it becometh us not to look upon agony of a comrade. Sufficeth to say that the next day the Salvation Army wagon calleth at the door, and the presents goeth into service to be used in a good work.

And if any of ye who readeth these lines hath friends or relatives who rejoiceth in the title of ham or bug, remembereth that to the radio man all things are radio, and rendereth unto him those things that are radio.

And those of you who wisheth radio gifts for Christmas might marketh this story, and leaveth this issue of RADIO where those who generally remember you will read, and heed. For it is for this latter purpose that it hath been written; ye scribe seriously contemplateth sending carbon copies to some dozen or so himself.

Which proveth that there is a reason for everything—even a yarn like unto this!

### RADIO KICK

By O. R. GRISSOM

This is Radio KICK, the first number is; "it ought to be against the law to have a graphophone in a broadcasting station," second number, will be a good story from some good magazine. Lots of people do not know there are good stories in magazines; we get a little on the side for this. The third number we will number the alph. Numbers are easier to get than letters, giving a man two chances to get the call right where he only had one before. When giving the call letters give corresponding numbers, i.e. KICK, 11-9-3-11.

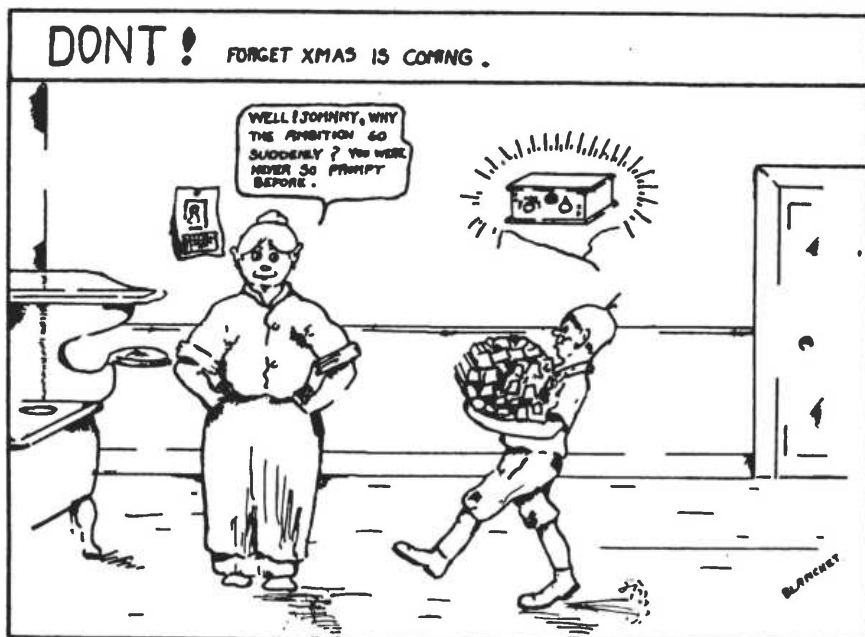



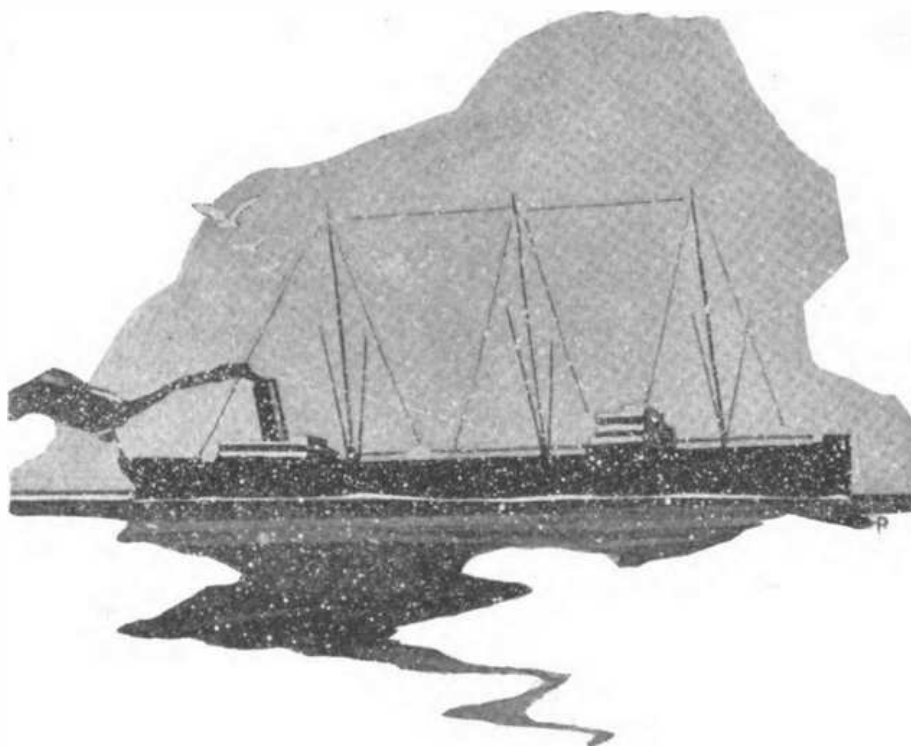
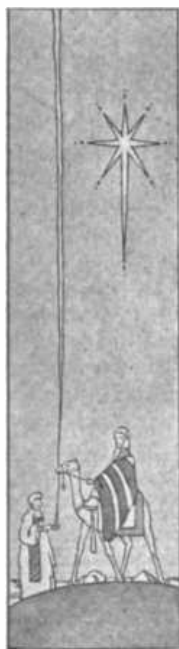

# Christmas Phantoms

by Earl Ennis

**W**ITH her wheel-house slightly awry, and two empty davits on her port side, the tanker *Susan Reynolds* skewered southward through the dull placidity of a copper sea, on the tail of a tropical monsoon. Only the lingering yellow haze along the distant horizon remained as a reminder of the two days of hell in which the vessel had wallowed.

"Bob" Norris, radio operator, arose from the floor where he had been patiently mopping up the spillage from his storage cells, and cursed the judgment that had sent him down along the South American coast, when he might have remained comfortably at home.

"Doddering ass, that I am," he growled to himself. "As English Joe used to say: 'I'm a ripping, blooming, bleeding, bally blighter.'"

Thereupon, having expressed himself like a true American, he thrust the matter entirely out of his mind, and set about washing his hands, whistling a cheerful chantey of the sea, the while. This done, he dropped down before his instrument, and listened briefly for a chance distress call, as required by the regulations.

In the parlance of his craft there was "nothing doing." The whip-crack of the static, omnipresent pest of the tropics, resounded in the receivers. Up the

coast, the naval station at Point Loma, argued with a distant destroyer, in the high querulous whine of Uncle Sam's official voice. But on the wave length on which ships usually summoned assistance there was only blank silence.

"Ho-hum," yawned Norris.

He slid one ear out from under the cap of his receivers, opened a drawer and took out a magazine, and cocked his feet up on the table. "Let's see," he went on to himself, "she was about to marry . . ."

He paused in the act of thumbing the pages . . . Then he shot bolt upright, the magazine falling unheeded to the floor. With a single motion he fed up his detector lamp, and twirled the condenser knob that gave him his wavelength changes, until the sound that had broken into his reverie came sharp and distinct. It was the bubbling drone of a radiophone's "carrier" wave. Not unusual off the States, but two hundred miles off Southern Mexico, quite another matter . . .

"Hello—*Susan Reynolds!*"

The voice broke in his ear. Norris' eyes opened in surprise.

"Hello—*Susan Reynolds* . . . Call Captain Hamish to the phone, at once, please!"

The operator sat motionless with astonishment. Then he flipped a switch and the generator of his transmitting set hummed into life.

"WWMQ — *Susan Reynolds*—r..r. received—, who—who?" he snapped back in Continental code, demanding the identity of the other.

The answer that came back was disconcerting.

"None of your damned business," growled the voice. "Get Hamish on that fone—quick!"

There was a surly nastiness about the tone that aroused every grain of fighting instinct in Norris. He glared at his glowing tube as though it had a personal responsibility in the matter. Then his hand sought the key again.

"Listen angelface," he drawled, in precise, staccato code, "if you want to do any business with WWMQ, better cough up a sine!"

The carrier wave was right on his heels, the voice surlier than ever.

"Don't get funny," it said. "I don't have to sine. Better see what Hamish thinks before you pull a bloomer!"

There was a cocksureness about the words that jarred Norris. Furthermore there was a note of menace in them that he did not like. He swallowed his impulse to snap back an insulting retort. Instead he squinted at the instrument. Then, being a very cautious and also a very canny young man, he laid down the receivers and went up on the bridge.

*Continued on page 46*

## A REGENERATIVE HOOKUP FOR THE LOOSE COUPLER AND VACUUM TUBE

By CHAS. R. FRYE

One of the greatest barriers that arise when the ordinary radio enthusiast wishes to change from a crystal to a vacuum tube detector outfit is the price of an efficient tuner. Without a good tuner he knows that he will not get good results, so he usually backs and decides to quit the radio game for life.

If, however, he does get a vacuum tube detector and uses it with a variometer, variocoupler, or tuning coil, he will soon become discouraged because he can not get the distant stations as well as his friend who has a high class

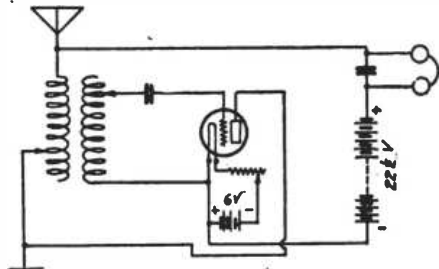

Regenerative Hook-Up for Loose Coupler and V. T.

outfit. If he has a loose-coupler, he may try it in a circuit that is commonly used, but even this will not give him satisfaction.

Now if you happen to be one of these fellows, do not get discouraged because in this article there is a ray of hope. If you have a loose-coupler you can use it as your tuner. If you have not, build one (the navy type is preferred because the scratching is not experienced as it is with the ordinary type when the slider contact passes over the turns of wire on the primary coil).

Here are a few suggestions for building a loose-coupler. Wind 60 turns of No. 22 double cotton covered wire on primary coil and 60 turns of No. 26 double cotton covered wire on secondary coil. Tap primary every five turns and the secondary every ten turns. It is advisable to put secondary coil on rods because if there is any up and down or side motion it is very hard to tune in those distant stations.

The next thing to consider is the detector. If you have a mounted detector you can use that even though you may have to make a few changes. Of course your detector does not have to be mounted, but it seems that having everything behind the panel is the style now. In addition to the loose-coupler and detector you will need phones, phone condenser and batteries.

After hooking up everything according to diagram try to tune in some station that you are familiar with. If you do not get good results at first, do not get discouraged. You probably do not know how to tune your loose-coupler. Since all loose-couplers are not made exactly the same, you will have to ex-

periment a little until you find out how to tune yours. After finding out you will never have any trouble in tuning those far-off stations.

Just to show you the results I get here in Pasadena, Calif., I will mention a few stations that I have heard. They are: KLP (Los Altos), KZM and KLX (Oakland), KDN and KUO (San Francisco), KYG and KGG (Portland), KQW (San Jose), KVQ (Sacramento), KWG (Stockton), and KDYL and KZN (Salt Lake City). I have heard ships up and down the coast and as far away as Hawaii. The near-by commercial and amateur stations come in comparatively as loud as the broadcasting stations.

You may think that my set is an exception, but when I tell you that several boys using this circuit have received these stations, and some farther away, you will know that it is not an exception. The beauty of this little outfit is that it costs very little to construct and gets results that some of those high-class sets do not get.

## AUTO TRANSFORMERS FOR AUDIO FREQUENCY

By DONALD K. LIPPINCOTT

**M**OST articles about the transformers to be used with audio frequency amplifiers contain a statement something like this: "The impedance of the primary coil should be equal to that of the tube with which it is used. The secondary should be wound for the highest possible voltage."

The statement, if I interpret it correctly, means that the designer of the instrument designs the primary circuit according to the ordinary electrical formulas, and then winds on all the wire there is room for and calls it the secondary, the ratio of turns usually being about 1:3½.

The inference from the above near quotation is that a ratio of 1:4½ is about 30% better than 1:3½, and this is very nearly true. What few people realize is that any 1 to 3½ transformer can be converted to the higher ratio with very little difficulty.

The answer, of course, is the auto transformer connection. The hook-up must be changed a bit too, but no real fan objects to that.

First examine carefully the transformer you intend to convert, and note which binding posts connect with outside and inside ends of primary and secondary winding.

All ready then: Connect the *outside* of the primary winding to the *inside* of the secondary. Then hook up as shown in the diagram. Outside of secondary to grid through a grid condenser. Inside of primary to positive B battery. Common primary-secondary lead to plate.

It will be noted that this hook-up has features in common with both reactance

coupled and inductively coupled amplifiers. Its disadvantage is that it frequently requires a grid leak—connect it from the grid to the positive side of the filament, *not* around the condenser, and make it just heavy enough to stop the howl. The pencil-mark type is best because of its easy adjustability.

There is another advantage in the auto transformer connection beside the increased voltage on the grid, and that is that it responds to a wider band of tones. The reason for this is two-fold. The first is that the closer coupling broadens the tuning. The second is that the core loss and resistance drop,

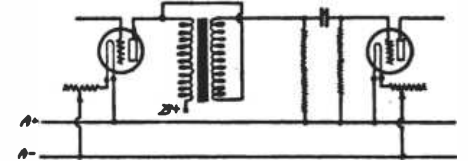

Auto Transformer Hook-Up

which ordinarily broaden out the primary tuning but have little or no effect on the secondary, are here introduced into the secondary circuit and are utilized both as voltage drop and to flatten out the response curve.

It will be noted that the diagram shows a resistance connected from the outer end of the transformer to the filament, ahead of the grid condenser. This is of the same type as a grid leak, and again the readily adjustable pencil mark is recommended. With the amplifier hooked up, detune until the music is coming in rather faintly. Then make your pencil mark, increasing its density until it begins to cut down the strength of the signals. As heavy as possible without lowering the efficiency—that's the way to leave it. Here again the idea is to broaden the response band and render the music with less distortion.

The amount of additional audibility that the arrangement will give depends on the original design of the transformer and on the tubes with which it is used, but it is an improvement in quality in almost every case.

## THE MYSTERY BOX

The W. W. Hodgkinson Corporation is about to release "The Mystery Box," a single reel feature produced by J. R. Bray and dealing with radio. This film presents a complete explanation of radio in its closest relation to the average person, and concludes with a prophecy of successful inter-planetary communication. Detailed and valuable information is given concerning all the essential principles of radio, including visualization of apparatus and instruments in use. Along with this there are numerous interesting and amusing episodes in regular motion picture photography which round out the explanation in very realistic and attractive fashion.

# Inductance Design

By Jesse Marsten

To figure the inductance of a coil is a task that many amateurs sidestep because of the mathematics involved. Such mathematics as appears in this article is comparatively simple and can be skipped by the reader who is satisfied with knowing "how" without learning "why." The accompanying curves will quickly tell the inductance without lengthy calculations.

FROM time to time there appear in the radio periodicals various articles dealing with the design of inductance coils. In general these articles take up the matter of the single layer solenoid and develop the standard formulas into very simple, practical engineering formulas facilitating quick design.

These articles point to a definite tendency—the simplification of formulas and design methods to assist the engineer and designer to calculate coils with a minimum of time and effort. However, in these articles the formulas given apply to special shapes and types of coils, and, as there are numerous shapes of coils which the engineer has to design, there will be a multiplicity of formulas, each applying to a definite shape, which makes matters a bit unwieldy and not so easy. Where an engineer has to design spirals, single and multilayer solenoids, multilayer coils having square and rectangular sections, etc., he has the added job of choosing the formula to fit the type of coil in hand, which obviously contributes much lost motion. What is desired is a single formula which is applicable to all shapes of coils with reasonable accuracy.

Such a universal formula for inductances has been developed by Prof.

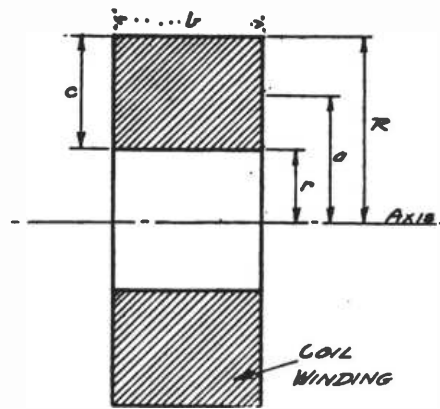

Fig. 1. Notation Used in Brooks' Universal Formula

Morgan Brooks of the University of Illinois. The formula holds for all shapes of coils in which the winding is a close one. It is a semi-empirical formula based on the theoretical proposition that the inductance of a coil is a function solely of the amount of wire used and the geometric configuration of the coil. The theoretical formula for the inductance of a coil may be written as follows in terms of the number of turns and the coil dimensions:

$$L = \frac{(2 \pi a N)^2}{b + y}$$

where

- $L$ —inductance in henrys.
- $a$ —the mean radius of the coil in cms.
- $b$ —the length of the coil in cms.
- $\pi a^2$ —the area of the flux path within the coil.
- $y$ —the length of the flux path outside the coil.
- $N$ —the number of turns on the coil.

The term  $y$ , the length of the flux path outside the coil, is of course the "nigger in the woodpile." It is different for all types and shapes of coils. In the Brooks' universal formula there is included another factor instead, called the "Shape Factor," which so modifies the above theoretical formula as to take into account this flux path for any shape of coil. This "shape factor" is the empirical part of the formula. The Brooks' universal inductance formula will be found to be sufficiently accurate for all engineering purposes and is given by the equations:

$$L = \frac{Cm^2}{b+c+R} \times \frac{F' F''}{10^9} \dots (1)$$

$$L = \frac{0.366 \left( \frac{Fl}{1000} \right)^2}{b+c+R} \times F' F'' \dots (2)$$

Equation (1) gives the inductance in terms of dimensions in centimeters,

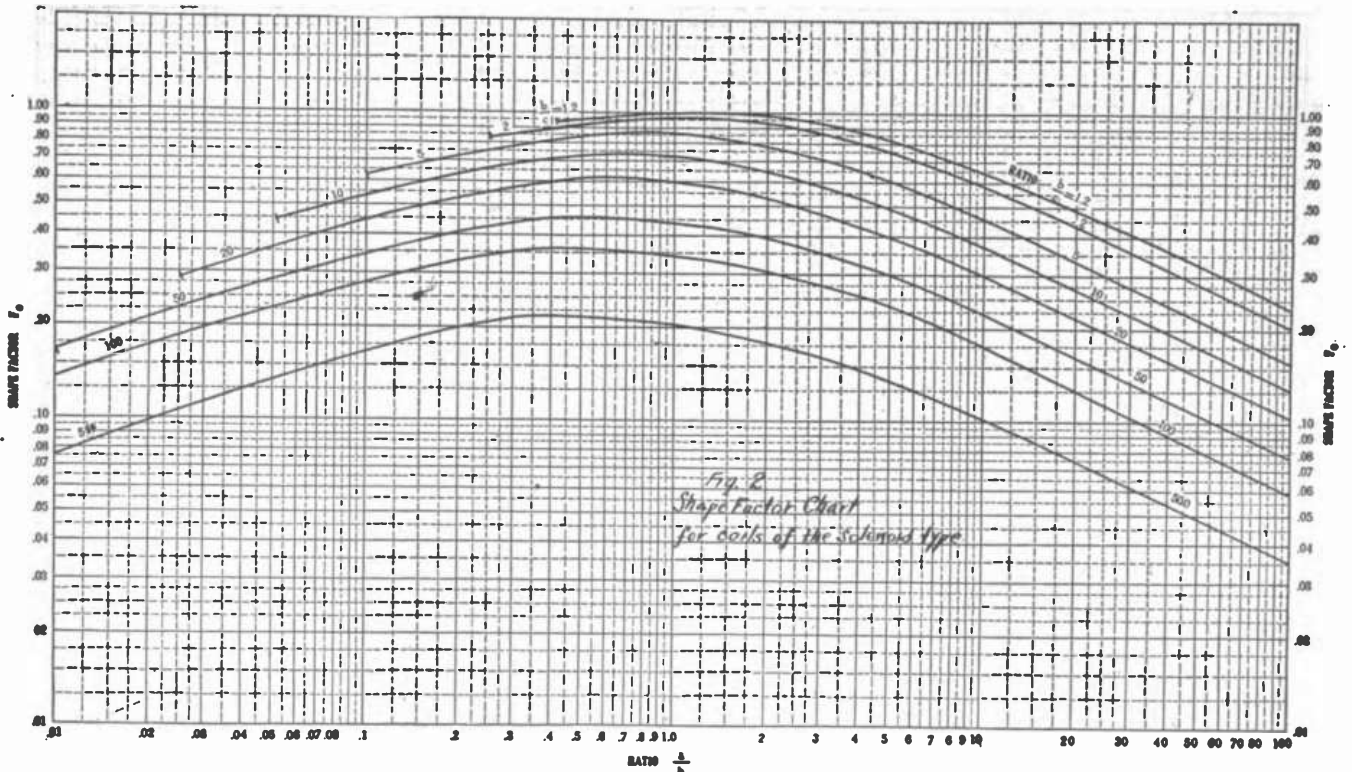

Fig. 2. Shape Factor Chart for Solenoid Coils

while equation (2) gives the inductance in henrys in terms of dimensions in feet and inches. The notation in the formulae is as follows; and is illustrated in Figure 1:

- a* is the mean radius of the winding.
- b* is the axial length of the coil.
- c* is the thickness of the winding.
- R* is the outer radius of the winding.
- C<sub>m</sub>* is the length of the coil winding in centimeters.
- Ft* is the length of the coil winding in feet.
- F'* and *F''* are the "shape factors" given by equations 3 and 4.

$$F' = \frac{10b + 12c + 2R}{10b + 10c + 1.4R} \dots\dots (3)$$

$$F'' = 0.5 \log \left( 100 + \frac{14R}{2b + 3c} \right) \dots\dots (4)$$

It is not necessary actually to calculate these shape factors from the above formulae, for curves are given which give the "shape factors" at a glance. These curves are here shown in Figs. 2 and 3. Fig. 2 gives the shape factor for coils of the solenoidal type, that is cylindrical types where the axial length is greater than the thickness of the winding. Fig. 3 gives the shape factor for coils of the disc type, rings and pancake types where the radial thickness, *c*, of the coil equals or exceeds the axial length of the coil. It will be seen that the curves give the net shape factor, or the product of *F'* and *F''*. The shape factors are given as functions of the ratios of *a* and *b*, and *b* and *c*. Hence it is merely necessary to obtain these ratios from the coil dimensions and find *F'*

*Continued on page 58*

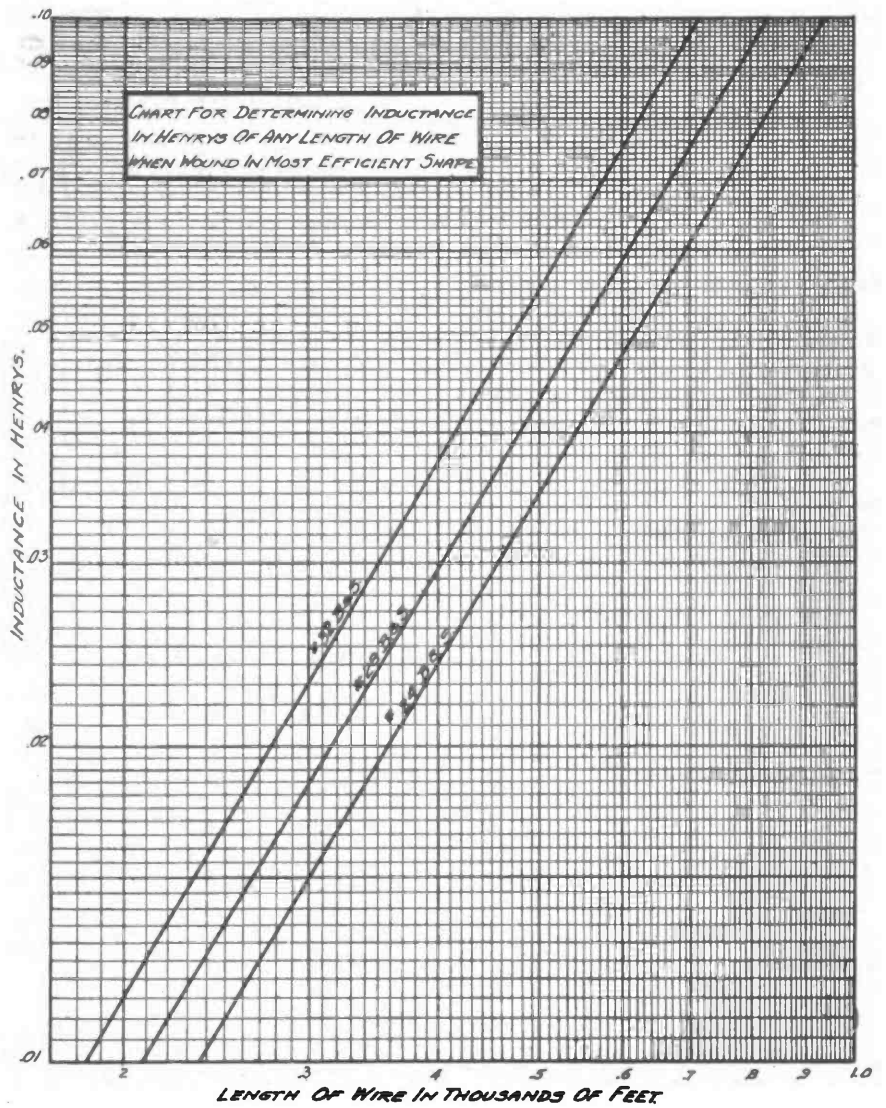

Fig. 4. Chart for Determining Inductance

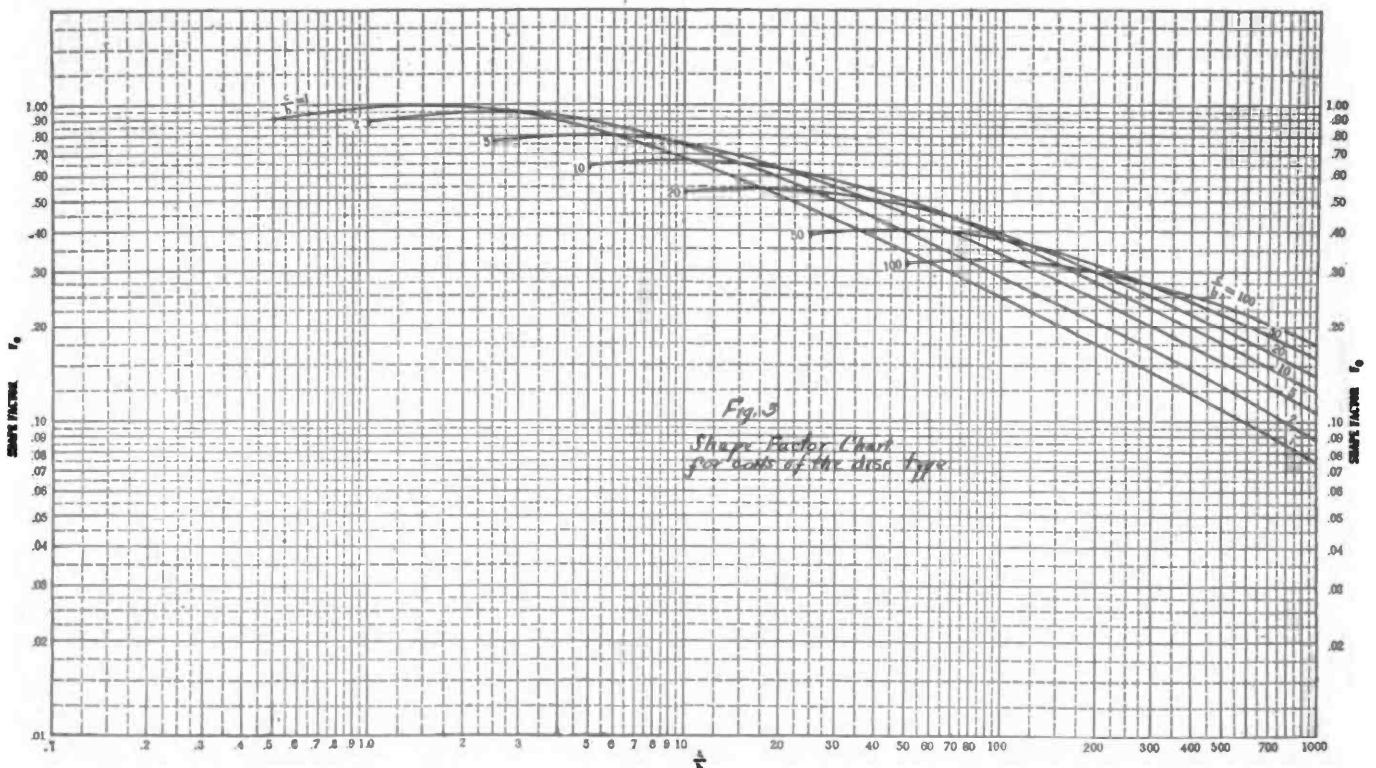

Fig. 3. Shape Factor Chart for Disc Coils

# Operation And Care of Motors And Generators

By D. B. McGown

*This, the first of a series of practical articles, is concerned with direct current machines. The second, to be published in an early issue, will deal with alternating current equipment. The author, who is assistant radio inspector at San Francisco, has a knack for simplifying complex subjects.*

**B**ASICALLY, a motor is a machine that converts electrical power into mechanical power. A generator is the converse. The term motor, electrically, may be applied to any type of machine that accomplishes the theoretical conditions laid down in the definition, but actually this is generally limited to the ordinary type of rotating machines which are used for power supply. The name generator as applied to include all

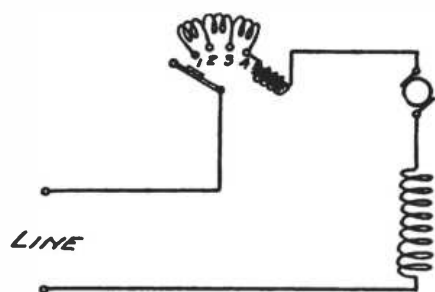

Fig. 1. Series Motor Connection

types of a.c. and d.c. machines for the generation or production of electrical energy, is similarly limited to a rotating machine, which is turned by some form of outside motive power.

We will first consider the series motor, connected as in Fig. 1. The line is connected through a series starting resistance, direct to the armature, and thence through the field to the other side of the line. When this type of motor is started, the starting lever is moved to point 1, and held there for a short time, the duration of the starting period depending on the characteristics of the load and the size of the motor. After the machine has gained speed, the starting lever is gradually moved over, until the starting resistance is cut out of the circuit, and the motor connected directly across the line. This lever is held in place by a magnet in series with the armature, against a spring, which tends to return it to the off position, and, if by chance the current should be turned off, or the circuit through the motor opened, there will be no chance of a short circuit, or sudden rush of current.

This series motor's armature rotates in the magnetic fields set up by the series field winding, and, as it is rotating, there is a secondary current set up therein. This is referred to as the back electromotive force, ("back e.m.f."). That is, the motor armature, while rotating, acts as though it were a generator armature, in that it actually generates current in its windings, but this current is directly proportional to the

speed of the machine, i.e. the greater the speed, the greater the value of the back e.m.f., and therefore, the less the value of the current flowing through the whole motor circuit from the line. Conversely, the slower the speed of the motor, the lower the back e.m.f. and the greater the current drawn from the line, which tends to again speed up the motor. At zero speed, therefore, the current would have nothing to hinder its path, except the low ohmic resistance of the windings, and if the full working voltage were to be impressed on the terminals of the machine it would be liable to burn out.

A series motor, therefore, "pulls" harder, the lower the speed. So at minimum speed, theoretically, its power would be infinite, if an infinite current could be supplied and carried by the windings. This is of immense advantage in certain classes of work, where it is essential to have enormous torque at the start, and where a reasonably high speed is also wanted after the motor has finally overcome the inertia of the load, and gotten it to running. Such loads are encountered in electric railway work, electric automobiles, and the like. The series motor will try to reach infinite speed, if allowed to run idle, and therefore it is not well suited to intermittent loads, as in radio motor-generators, requiring a shift from full load to zero load almost instantaneously.

For such loads, another type of d.c. machine is usually used, known as "shunt wound," so named from the fact

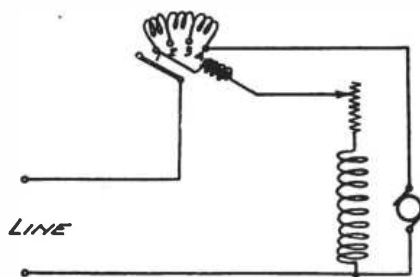

Fig. 2. Shunt Motor Connection

that the field and armature are connected in shunt to one another, and then across the line. The fundamental circuit of this type is shown in Fig. 2. Here, the line is connected in the final, or running position, point 4, directly across the armature, without the field winding in series, while the field is excited by the line current as well, and is also connected directly across the line, but with a resistance in series, to limit

the current. The action of the starter for this type of motor is identical with that for the series motor, but, as the back e.m.f. generated by the armature is independent of the armature current, more constant speed is obtained. The actual functioning of the armature is the same as the armature of the series wound motor, but is limited in its action by the independent control of the field rheostat. The weaker the field, the

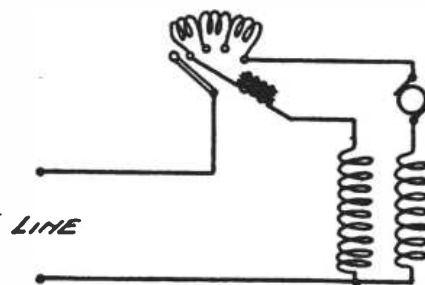

Fig. 3. Compound Motor Connection

greater the power generated, if the machine is operating at constant speed or load. If the load is variable, the greater the speed, the weaker the field. This is effected by a reduction in the back e.m.f., which occurs every time the field current, and consequent density of the field flux, is reduced, and the net result is to increase the armature current in proportion to the weakening of the field. A reduction of speed is taken care of in the reverse order, i.e., by increasing the density of the magnetic field, until such a point is reached that saturation takes place, beyond which no increase of field current will help, due to the iron's carrying all the magnetism (so to speak) that it is able.

A different type of motor connection which involves a combination of the other two types is the "compound" wound machine. This has the heavy series windings on the field coils, in series with the armature, and also the shunt windings in parallel thereto. This type of motor is shown diagrammatically in Fig. 3. This type of motor possesses the advantages of both a shunt and a series wound machine, and is especially desirable when the load is rapidly changed. The speed of this type of motor is regulated by the strength of the shunt field, when running idle, and the instant the load is thrown on, the increase in the current in the series field permits the full power of the motor to be utilized as soon as it is needed. The speed control rheostat is placed in series with the shunt field, and

acts in the same manner as the field rheostat of the shunt motor. Another type of compound wound machine is the differentially compounded motor, which, however, is seldom used. It is so connected that the field flux *decreases* as the load increases, and may be made so that it even may increase in speed when the load is increased.

The speed of these various types of motors depend on several factors. First, in a series motor, the speed is determined, within limits, by the applied load, while the shunt motor's speed is limited by the field current, which changes the density of the magnetic field in which the armature turns. Stated mathemati-

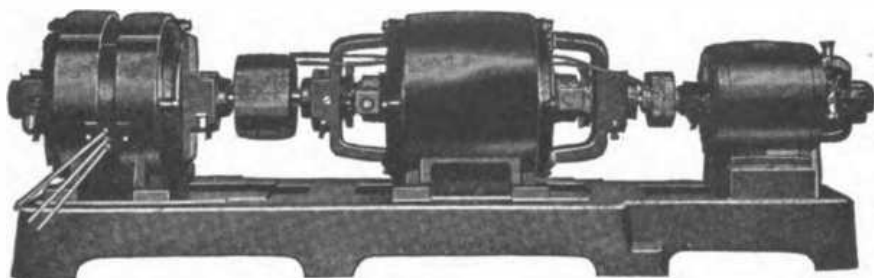

Typical Motor-Generator Set for Radio Use

cally, the speed of a series wound motor varies inversely as the impressed load. A shunt wound motor, when loaded within reasonable limits of power, does not change its speed with changes in the power, provided this load is changed gradually, as in ordinary mechanical operations. But where sudden variations of the load are encountered, as in radio work, it will not remain at constant speed. Few people realize that the motor turning over an ordinary generator, as is used to run the a.c. generator for a spark transmitter, is performing the hardest kind of service that electrical equipment is subject to. When it is considered that with the sending key open there is practically no load, and that the closed key gives a full load, it can be easily seen that the intermittent operation of the key, as is essential to form the signals of the telegraph code, throws the load on and off with great rapidity, and in effect is almost like a hammer blow to the armature when the load is thrown on, and the sudden release of the key throws almost as severe a strain on the mechanism.

Direct current generators are the converse of motors of similar types. A generator is supplied with power, in the form of rotational effect, from some source of outside power, as a gas engine, steam turbine, water turbine, etc., and it generates electric current by the motion of the armature or field conductors through a magnetic field, which sets up a current in these conductors, which, after being led through suitable electrodes, or collectors, is used for various purposes for which it may be adapted.

Direct current generators are con-

nected like the motors, as series, shunt, or compound wound machines. The series type has not found very general application, as it must be used on circuits having a constant current, as for example for street lighting, and must be provided with regulator which can be adjusted to compensate for small changes in the load.

Shunt wound generators are adapted for constant potential circuits, as for example, on ordinary lighting circuits, using incandescent lamps in parallel, where the potential must remain constant, or serious trouble will occur, due to the lamps burning out. However, if the load is raised to such a point that

it tends to even slightly overload the machine, a rapid decrease in voltage will result, which is naturally undesirable.

Again, as with the motors described, the compound type of generator is the most used, and most desirable type of generator for average work. It possesses a series and shunt field, like the motor, and is usually so wound that it maintains a constant potential at the terminals of the machine, no matter what the load conditions are within normal limits, but can be so designed that it will give even an increase in voltage as the load rises. Compound wound machines are used generally for a source of direct current supply. The regulation, as the self-adjustment of the voltage is termed, is usually good, and little attention need be paid to the machines beyond the normal care necessary for correct lubrication, etc.

Radio generators, as used on the plate circuits of vacuum tubes, are usually compound wound, and usually give extremely satisfactory service. In some of the smaller sizes, where the voltage drop on load is not so important, they often are shunt wound.

One special type that deserves mention, owing to its being used in small portable vacuum tube radio transmitting sets, is the "dynamotor." Dynamotors are so constructed that they are, as the name suggests, both dynamos and motors. Fig. 4 shows the schematic connections for the ordinary dynamotor; the motor end is supplied with d.c., and runs at the speed, and under the conditions determined by the designer; the generator end is connected to windings, which are placed in the same slots as are used for the armature windings of

the rotor end, but, of course, carefully insulated therefrom, and the same field is used for both circuits, i.e. the shunt field of the motor end serves for the same field as is used for the generator. The windings of the generator are proportioned so as to give either a higher or lower voltage, as may be desirable, which is then taken from the output side in the same manner as if the machine were an ordinary generator.

The dynamotor possesses several important advantages, and some almost as serious disadvantages. It can be made light, and is of convenient form, and where a light or intermittent load is used, it will operate with good satisfaction. It possesses only one set of bearings, and is contained within one complete housing, and is reasonably efficient. The chief defect lies in the impossibility of any effective system of voltage regulation on the output side. As the field strength is fixed, by the winding of the motor end, no variation of this is possible, without disturbing entirely the operation of the machine as a whole. The machine is built to give a constant potential, and a constant current, and will do so, provided it is not seriously overloaded, but no regulation by any outside

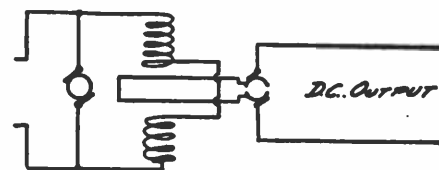

Fig. 4. Dynamotor Connection

method is practicable, except the very poor system of lowering the supply voltage. While this can be done, and some regulation obtained this adjustment can be only carried on within very narrow limits, which are usually too narrow to be of much value, as the capacity of the machine drops as soon as the voltage is lowered. A series resistance, in the supply circuit would accomplish the same result, of course, with the same rather unsatisfactory action.

## SECOND DISTRICT CONVENTION

An annual affair that is the culmination of all radio for the season is held every year by the Second District Executive Radio Council at New York City. This one will be the third of its kind, and everyone who attended last year's Show and Convention can vouch for the success of the affair. Next year the Convention will be held at the Hotel Pennsylvania, March 1st, 2nd and 3rd. It is planned that any of the Radio Clubs affiliated with the Council will have booths at the Convention, and there will also be some of the historic radio sets on view. The Convention will be open to licensed amateurs and their friends only.

# Are Shorter Wavelengths Worth While?

By Walter Emmet

*The "New West" in radio is down among the comparatively unknown shorter wavelengths. The discoveries of the future will be in this realm. Hence it behooves the progressive amateur to become familiar with this region through reading such surveys as this.*

THE recent outburst of interest in the super-regenerative circuit of Armstrong points the way to new demands for short waves among radio experimenters and designers.

Hertz showed directional properties of very short waves in 1887, Ladd and Stone in 1901 and Marconi in 1922. These waves behaved like light waves. The shorter the electric wave the closer the family resemblance became and the more accurately could one predict its exact behavior. If it struck a metal screen it was regularly reflected. If it met a prism of pitch or sulphur it was correspondingly bent like a light ray going through a prism of glass. In all possible experiments the electric wave, as it became very short, showed that light and electric waves differed only in wavelength; they had the same velocity in space and both could be projected by proper reflectors like a beam of radiation almost as narrow as a search light.

Any thoughtful student of radio history who is not familiar with the early tendencies in radio would fail to understand the drift away from short waves, which has not ended with 24,500 meters for the 1000 kw station at Bordeaux, France (LY), or recently projected stations calling for 30,000 meters. Such frequencies can be heard directly in the head receivers without any heterodyne by many persons.

The deciding factor which gave a steady direction to this development was the requirement of greater power. Spark stations stopped with about 70 kw in the antenna in 1910. The arc, the "timed" spark, the alternator and finally the vacuum tube respectively have been called upon to radiate energy until today approximately 200 kw is reached.

Large electrical structures, in aerial, and ground or counterpoise are necessary to take up this vastly increased energy flow. Hence the natural wavelength, which should rarely be more than half the traffic wavelength, called for longer waves. These in turn offered a lower resistance due to radiation, or were inefficient relatively to short waves, but the current was greater, and the current squared, determined a net gain in radiation from an engineering point. Commercially these structures are like the prehistoric monsters of the coal age—any sudden economic development cheapening transmission would render them an incumbrance and they will disappear. An efficient static reducer

would scrap most of them in the immediate future, as one thousandth part of their energy will suffice for all transoceanic radio communication.

Many pioneers tried modulating a stream of sparks which in the case of Elihu Thompson's direct current oscillator of 1892 gave practically a stream of interrupted arc discharges. This method gives from 5,000 to 50,000 "jigs," sparks or wavetrains per second and clear articulation—with low power.

Collins, Fessenden and others, in their early radio telephone experiments, used waves much shorter than 1000 meters, which then was considered long. Today it is considered just on the verge of medium waves. More power for longer distances soon necessitated the use of 1500 meters. Fessenden's high frequency alternator gave this. It bridged Brant Rock, Mass., and Babylon, L. I., by radio telephone, but there was no commercial development from it, in spite of its being a record at that time.

Soon after this, new work between Machrihanish, Scotland and Brant Rock caused the wavelength to be raised to more than double the above value, while the power and the natural period of the antenna in all transmitting stations went up together, in order not to lose radiation. The radio designers looked "knowing" but they were only making a virtue of necessity: they had to increase the wavelength with the power, for practical reasons.

Further experiments by Fessenden brought up questions whose answers would determine the general design of transmitters in the light of the data accumulated by Austin and Cohen. There was a best wavelength for a given distance, on account of absorption, bending, earth losses, etc., in an electromagnetic wave. "Fading" and "static" were all-important factors whose effects could only be averaged by extensive experiments. Fessenden found that one did not get the best all around reception over long periods by using the longest available wavelengths. Four thousand meters gave better results than 8000, and it is only again after 15 years that the Dutch engineers, through tests between arc stations in Java and Holland, have come to decide on 4000 meters as better than longer waves. In the latter case, static seemed to become more violent.

The U. S. Government in 1910 and again in 1912 shoved the amateur into the wave "pocket" below 200 meters. Suddenly those who wanted distance—

and always more distance—bitterly complained of the drab outlook of their prospects in making new records. They very seldom if ever ventured under 200 meters, however, and many preferred to creep up around 350 meters. None seemed to draw the conclusion that they were in a safe harbor, electrically speaking. Experimenters like Armstrong and Bolitho dove for results and we have the super-heterodyne and the oscillator-quencher, which became the super-regenerator in the U. S. Others nourished vague hopes of being ultimately assigned a longer upper wave limit, but this immediately encroached on the international ship-wave of the time.

Knowing what careful experimenters can contribute to practical knowledge, it is the acme of irony to find that the "lost province" of amateur radio below 150 meters was taken over by the government, largely because the amateurs were too preoccupied after 1919 to use C. W. high-power tubes after W. C. White's suggestions for experiments with ultra short waves. In England they had longer waves and their experimentation was closely regulated.

## SHORT WAVES AND STATIC

Static is the cancer eating at the heart of radio communication. Any new departure must first be judged in the light of its effect on static. The position of the short wave is singularly strong in regard to immunity conferred on radio apparatus from static. There are at least six types known and classified but they all will break up a telephone or broadcast speech where music or code would not be seriously affected. Static is the greatest enemy to be overcome in broadcasting.

When static comes in, most "reducers" balance it out or localize it while leaving the side tones and carrier waves undisturbed. For long waves this is a hundred times as difficult to do without distortion as with very short waves.

Short waves have had a final endorsement in the remarkable results obtained by Armstrong in America and Bolitho in England by the use of unbalanced oscillating circuits working at 50 meters and under. These circuits "run away," 10,000 times a second or more for broadcasting reception and are prevented from "spilling over" into steady oscillation by a "quenching circuit" consisting of an oscillator which undoes the work of the

*Continued on page 66*

# Power Supply for Vacuum Tube Transmitters

By Charles K. Fulghum

*Herein is presented a comparison of various practical methods for obtaining non-pulsating high voltage direct current for vacuum tube oscillating circuits employed for radiophone or C. W. work. The treatment covers batteries, d. c. generators and pre-rectification methods, but excludes circuits using alternating current as a power source.*

## BATTERIES

**D**RY batteries may be used as a source of power for vacuum tube detectors or amplifiers employed in wavemeter calibration or external heterodyne circuits. Detector tubes usually will oscillate on 50 volts without "bluing" and 200 volts may be used with amplifiers. Plate current of from 10 to 20 mills-amperes may be secured for temporary purposes from a block of dry cells costing from \$10 to \$15.

Small storage batteries are more economical, as the initial cost is from 40c to \$1.00 a cell and as the cost of recharging is low. A battery of the Plante type can be made by the experimenter for less than ten cents a cell, using large test tubes as containers and strips of sheet lead as electrodes.

The use of batteries of either type is recommended only where oscillating circuits of small power are to be used temporarily. Occasionally small 'phone or C.W. transmitters may be operated on power derived from batteries, but where the installation is permanent, some other source of power should be used.

## D. C. GENERATORS

Generators for radio use are high voltage machines operating at from 350 to 2000 volts with loads rarely exceeding 3 amperes. As a rule they are not required to operate over extended periods of time, but when this service is required of them especial care should be taken to see that the load does not exceed 75 per cent of their rating. This precaution should be observed for three reasons: insufficient driving power, the temperature rise factor, and because operation at abnormal loads gives rise to "swinging" and "fading." The first factor may be eliminated by correct design.

All generators heat up to a certain degree. As long as the load is not increased the temperature will remain constant, but increased loads, especially if abnormal, cause the temperature to rise rapidly with resulting deterioration of the insulation, which will sooner or later mean a burnt out generator. The amount generators will heat in ordinary operation depends, of course, on the allowance the manufacturer has made for the temperature rise factor. As an example, the generators manufactured by the Electric Specialty Company of

Stamford, Connecticut, are "figured on a basis of about 1 hour full load at 40 degrees C. rise. For continuous operation (four hours or more) allow 70 to 80 per cent of rating given. All machines will deliver 25 per cent over load for one half hour." Similar data may be obtained from other manufacturers.

Generators in operation require proper oiling, freedom from dust, and maintenance of the commutator and brushes in good condition. If sparking at the brushes develops the machine should be shut down and the trouble corrected.

All leads should be well insulated, and, if possible, enclosed in rigid or flexible metallic conduit to avoid possibility of shock. The generator and attendant driving power, which is usually a motor, ought to be placed in a room separate from that occupied by the transmitting equipment proper. Otherwise, in mounting the motor and generator, care should be taken to see that no vibration can be conducted through the walls or floors to the transmitting equipment, as vibration of the tube elements cause extraneous noises in the radiated signal.

The advantage of the high voltage direct current generator over other equipment are few and are usually derived in special cases where expense is not considered. The current obtained must, for the best transmission, be "filtered," and the construction of a filter for this purpose is as costly as the construction of one for use with other equipment.

High voltage generators rated at from  $\frac{1}{2}$  to  $1\frac{1}{2}$  k.w., delivering from 350 to 2000 volts, may be obtained for from \$75 to \$250. Similarly, generators rated from 25 to 300 watts operating at from 350 to 500 volts cost from \$25 to \$60. This, of course, excludes the cost of driving power.

## PRE-RECTIFICATION METHODS

One of the most satisfactory methods of obtaining a high voltage direct current is by the "pre-rectification" method. Briefly, this consists in stepping-up alternating current of 110 or 220 volts, by means of a suitable transformer, to potentials slightly greater than those required by the tubes to be operated. Both halves of the cycle of this high potential alternating current are then rectified and the pulsating direct current

obtained passed through a suitable filter circuit before being used on the plates of the tubes.

Three methods of rectification are available: electrical, chemical, or mechanical. Electrical methods of rectification make use either of the one-way conductivity of a gaseous medium due to ionization, or to the electron flow from heated bodies. Of the methods devised, i.e., rectification by kenetrons, S tubes, magnetrons, and arcs either of the Cooper-Hewitt or open air type, only kenetron and S tube rectification have found practical use in amateur installations. The instability of the arc does not warrant its use for this purpose, and magnetrons are, as yet, unavailable. However, kenetrons and S tubes are easily obtained, and, with properly designed equipment, offer an excellent means of obtaining high tension direct current. The initial expense of either type of equipment is practically the same, but, due to the unusual life of the S tubes (at least three times that of similarly rated kenetrons), the latter are recommended.

The best circuit for either type of tube seems to be the "split secondary" hook-up, which calls for the use of a transformer with a secondary designed for twice the required voltage with a mid-tap in the secondary winding. The circuit is so common that comment is unnecessary, and available data may be had in practically any publication on the subject.

Equipment employing either type of tube requires little attention, once the initial adjustments are made. Both kenetrons and S tubes will hold up under extreme overloads for short periods of time, but overloading the tubes should be avoided and operation at the rated loads maintained if a maximum tube life is to be expected. The cost of this equipment is usually from one-third to one-half that of similarly rated generator equipment, and the operating expense is slightly less.

Electrolytic rectification has gained favor because of its low cost. The equipment is similar to that used in vacuum tube rectification, with the exception that electrolytic rectifiers are used instead of vacuum tubes. The action of the rectifier is caused by the formation of oxide films on strips of aluminum immersed in a suitable solution. The solutes commonly employed are sodium borate, sodium phosphate, and certain compounds of phosphoric



acid. Sodium borate (borax) has been found as good as any.

Aside from its cheapness, electrolytic rectification possesses certain disadvantages. The equipment is far from being compact, and it must be located in an easily accessible place, for it not only requires constant attention while in operation but the plates must be frequently cleaned and the electrolyte renewed.

Mechanically, an alternating current can be rectified by the "synchronous commutator" method, which, though found in but few installations in this country, is possible of development. The initial cost of the equipment would probably be slightly greater than that of vacuum tube equipment, but the life of the apparatus is indefinite and it requires only the care that any commutator equipped device should receive. The device itself, if designed to operate from an alternating current circuit, requires a synchronous motor to drive it. Current is taken from the 110 volt mains and stepped-up to the required voltage. By means of a commutator device driven by the motor, this high voltage current is rectified. Similarly, direct current from the mains or from a storage battery may be converted into an alternating current, its voltage then raised by a transformer, and the alternating current then rectified. This possibility makes the device of interest to users who are isolated from an alternating current supply. The apparatus is possible of wide variation in design.

Summarizing, it may be said in favor of pre-rectification equipment that the expense is less, both initial and operating, it requires less attention, it is usually more compact, it possesses none of the disadvantages of mechanically-driven apparatus, and it permits the use of alternating current for lighting the filaments of the transmitter tubes. While alternating current can be used for this purpose with tubes supplied with direct current from a generator, there is usually noticeable in the radiated signal an alternating current "hum," while with pre-rectification equipment this "hum" is automatically balanced out. Alternating current for filament heating is not only cheaper than direct current, but by using properly designed filament heating transformers the current flowing from the plate to the filament is carried equally by all portions of the filament, thereby prolonging the life of the tube.

The direct current obtained from generators or from pre-rectification equipment is pulsating in nature, and to prevent this pulsation from being impressed on the radiated signal it is necessary to "smooth it out." A circuit for affecting this change is known as a "filter" circuit, of which at least two types are in common use.

As originally developed with kenetron rectification, a large condenser shunted across the high voltage direct current leads was used to reduce the voltage fluctuation. According to Dr. Goldsmith, in his work "Radio Telephony," "If the current drawn from the charged condenser is comparatively small (which will be the case if the condenser is very large and a small current at high voltage is drawn therefrom), the potential difference at the terminals will remain appreciably constant." It is, however, neither theoretically nor practically possible to obtain in this manner an absolutely constant potential. If, however, the amateur wishes to use condensers only for this purpose, the use of the Mershon electrolytic condenser, placed on the market by the American Radio and Research Corporation, is recommended. The capacity of this condenser is given as 38 micro-farads, and, aside from the advantages of high capacity and compactness, it is self-healing when punctured by abnormal potentials. Oscillographs show very little voltage fluctuation when this condenser is used as a filter.

However, for the best "smoothing out" action, a choke coil of several henrys placed in the positive high voltage lead with a condenser of high capacity shunted across the leads between the choke and the plate connection should be used. Better yet, a choke coil in each high voltage lead with a condenser shunted across the leads on either side of the choke may be used, and the voltage fluctuation with this arrangement is practically nil. For the design of such circuits and formulae for the calculation of the constants of the condensers and chokes, the reader is referred to an article by Dr. Hull in the February, 1916, "General Electric Review."

#### HOW A RADIO RECEIVER WORKS

A telephone receiver consists of a permanent magnet, which acts upon a metal diaphragm. Around the poles of the magnet are wound fine coils of wire, which vary the magnetic attraction upon the diaphragm and thereby cause it to vibrate at the frequency of the "audio" waves. The alternating current resistance effect of the coil to the carrier frequency, which is 875,000 cycles per second at 360 meters, is very high. The voice frequency varies from 300 to 1,200 generally, and it is the superimposed voice envelope which is the current actuating the diaphragm.

In order to shunt the carrier frequency across the headphones, which are in series with the circuit of the receiving set, a small condenser is placed in parallel to the headset. This will not permit audio frequency to get through, but forces it to circulate through the headphones.

#### VARIO-COUPLER WITH ZERO CAPACITY

An interesting departure in the design of a vario-coupler has been made by Alfred Crossley, radio engineer with the Bureau of Engineering, U. S. Navy, who has substituted a 40-turn spider-web rotor for the usual form of secondary coil. This gives maximum coupling when the plane of the spider-web



*Vario-Coupler with Spiderweb Rotor*

is parallel to the plane of the cylindrical primary and minimum when at right angles.

The base, instead of being made of bakelite, uses hard rubber containing less than 1 per cent of free sulphur. It is claimed that this vario-coupler is extremely selective and gives particularly good results with radio frequency amplification as it has an electro-static capacity of less than 1 micro-microfarad at zero coupling and 5 micro-microfarad at maximum coupling.

#### WIRELESS WONDERS

Attendance at our meeting house  
Was limited to one starved mouse;  
Until the thought struck Deacon Snow  
To make us good by radio.  
The folks they all turned out for fair  
To get religion from the air;  
But Deacon must have crossed his  
wire—  
'Cause that dern box up in the choir  
Yelled out, "Babe Ruth is now at bat,  
Dusted the plate off with his hat.  
Strike one—the crowd in great suspense;  
Busted a homer to the fence."  
A fool kid whooped right out,  
"Eeyow!"  
And Deacon mopped a clammy brow;  
But our folks 'ten church as they should  
Since science came to make us good.

—M. H. R. in Louisville  
Courier-Journal.

# NEWS OF THE BROADCASTERS

## K. F. D. B.

By Ralph M. Heintz

SEVERAL months ago the Mercantile Trust Company of California, wishing to serve its patrons and business associates with financial news, market reports, expert advice, stock and bond market quotations and news of such nature, conceived the idea of establishing this service through the agency of the radiophone. As the bank's scope of business covers the Pacific Coast west of the Rocky Mountains, as well as several of the Pacific Islands, the power needed was quite large. Plans were immediately laid for a station capable of putting 1000 watts into the antenna to cover this entire area should need arise.

Because of the fact that variable powers were necessary, the master-oscillator power-amplifier system was selected as being the simplest arrangement for fulfilling the various needs. The master oscillator is a complete set in itself and has been used for some time awaiting the completion of the power amplifier. When used directly on the antenna it has an output of 50 watts and serves as an auxiliary set when only short distances are to be covered. It is equipped with its own generator and power supply as well as its own system of control. It is provided with one 50 watt tube, as oscillator, and one 50 watt tube as modulator. A 50 watt tube

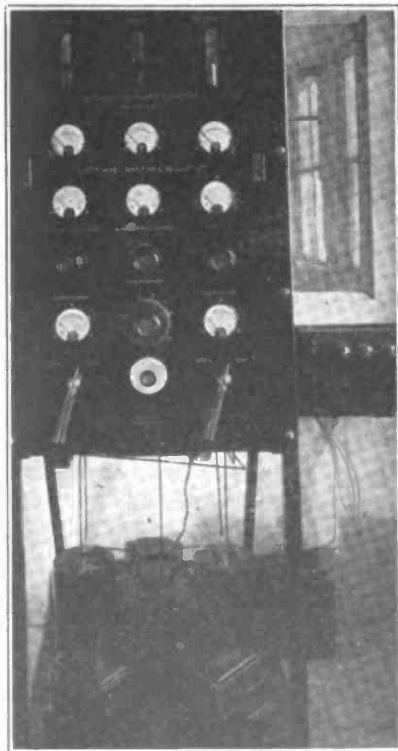

Fig. 1. Master Oscillator

is capacity-choke-coupled to the modulator tube as a speech amplifier. The circuit is known as the tuned grid reverse feed-back. This circuit was chosen after preliminary experiments as being the best suited to the needs and is certainly as efficient as any circuit so far tried. It has the advantage of ease of tuning, which is especially desirable where several wavelengths are used.

Each tube is provided with its own filament voltmeter, filament control and plate milliammeter. The remaining two meters are the output radio frequency ammeter and plate voltmeter. An oil variable condenser con-

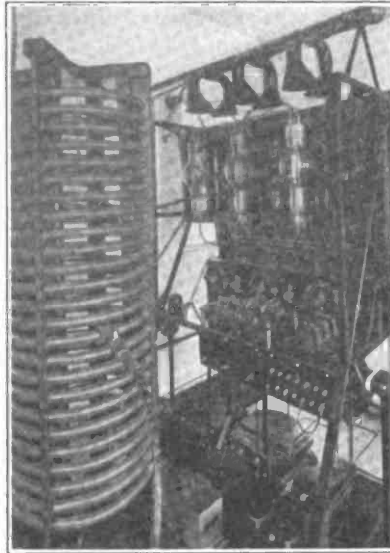

Fig. 3. Rear of Power Amplifier

trols the grid and is operated by the center knob shown on the panel. Above this knob is the field rheostat control. The outside knob varies the field by 350 ohm steps, the inner knob acting as a finer adjustment between the larger steps. This makes it possible to accurately control the plate voltage. On the lower shelf are located the filter reactors and filter condensers. There are four of these reactors, each of 20 henrys value. These are bridged by two condensers, each of 6 mfd. capacity. The remaining reactor is the constant current plate choke. The lefthand handle at the bottom of the panel controls the wavelength switch which makes it possible to instantaneously change the wavelength. The righthand handle is the "Send and Receive" switch. It not only controls the circuits of the master oscillator but also of the power amplifier. This switch is provided with a dashpot which offers resistance to movement toward the "send" position providing a time lag for the filaments to come to full brilliance before the plate potential is applied. This set is also provided with a relay and chopper, giving a 600 cycle note for I. C. W. telegraphy. This relay is worked from an ordinary telegraph key, or bug, and breaks the grid circuit of the oscillator tube for C. W. telegraphy. The chopper is connected in the microphone circuit and operates through the modulator tube. The generator supplying the plate of this set is of 500 watts capacity. It is mounted on rubber legs and is practically noiseless in operation.

The master oscillator and receiving equipment are in a separate room electrostatically shielded from the power room. A sound-proof partition serves to exclude the generator noise. The power room contains the two generators and power amplifier.

The power amplifier is provided with six 250 watt U. V.-204 tubes, each with its own filament rheostat. The tubes are mounted on a spring cradle so as to relieve the tubes from jar and generator vibration. The grids of each tube are provided with a radio fre-

quency choke to minimize intervalve oscillations.

Fig. 3 shows the filter reactor of 40 henrys and plate reactor capable of accommodating two amperes at 2000 volts. There are four filter condensers each of six microfarad capacity shunting the fifth reactor.

The filament transformer is one of 1 kw output, which is in turn fed by a 1 to 1 ratio transformer in order to doubly isolate the filament supply from the line. The 3 kw generator is capable of supplying 2000 volts at 1½ amperes. This generator is also electrostatically shielded from the power amplifier. The main inductance is wound of 1 in. copper tubing, 25 turns, 14 in. in diameter, and is located directly back of the power amplifier out of the field of the various transformers and chokes.

The amplifier is controlled by a motor driven time lag relay which is in turn controlled by the time lag changeover switch on the master oscillator set. A time lag of five seconds takes place between the time when the filaments are lighted and the plate potential is applied. As a safety measure each filament is supplied with a relay which in turn operates a second relay, so that, should a filament fuse blow or a filament burn out, the set is automatically shut down. It is quite apparent that should one of the six tubes burn out there would be danger not only of overloading the filaments of the remaining five but the plate current may also rise to a point which might prove dangerous, due to the fact that the oscillatory cir-

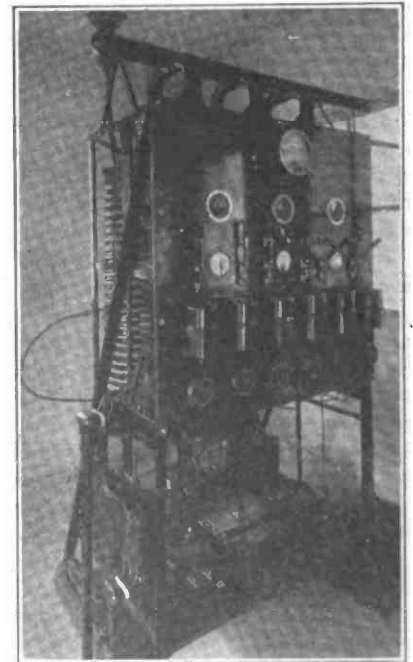

Fig. 2. Power Amplifier

cuit may become detuned. This arrangement also gives warning when starting up that a certain filament is not lighted, so that the operator can locate the trouble.

The entire station is controlled remotely through the agency of six push-button switches so that the operator need not rise from his seat. The station is also provided with a system of inter-connecting switches whereby the small master oscillator set can be made to operate as a 50 watt transmitter; also the power amplifier may operate independently as a transmitter, using one, two

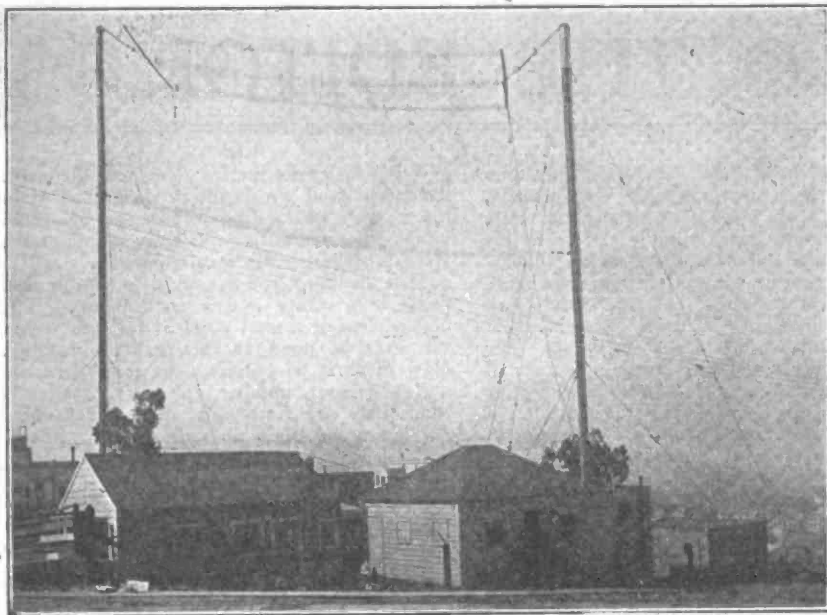

Fig. 4. Site of KFDB

or three tubes as modulators and one, two or three tubes as oscillators. When used in this way a separate 100 watt speech amplifier is used. The simultaneous operation of these two sets will in no wise conflict and broadcasting on two different wavelengths, say, 360 and 485 meters can be carried on at one time. A single cage antenna at right angles to the main antenna is in this case used for the 50 watt set.

The receiving equipment consists of a Colin B. Kennedy Company Universal receiver and two step amplifier.

The antenna is supported by two 110-ft. poles, spaced 90 ft. apart. The antenna itself is composed of three 14-in. cages spaced evenly on 24 ft. spreaders, while the down-

lead is No. 0000 stranded conductor. The counterpoise is arranged fanwise, radiating from the station house. It is 100x150 ft. in area, composed of No. 12 wires spaced 3 ft. at the outside supporting cable.

Fig. 4 conveys a fair idea of the general layout of the station.

The station building is of reinforced concrete of Class A construction throughout. The building to the left of the station house is the studio, of which Fig. 5 is an interior view. The studio is 18 ft. x 24 ft. in size and its walls and ceiling are draped in loose folds, following the practice of the better broadcasting stations in the east. The studio is carpeted over heavy felt wadding so as to deaden the sound. A grand piano stands in one corner and is provided with its own pick-up microphone. Other microphones besides the portable ones are hidden from view back of the drapes. The output of these microphones is amplified by a 10 watt "push-pull" speech amplifier which acts directly on the grid of the main speech amplifier tube. Microphones of special design are used for picking up the broadcast program. These microphones make use of a

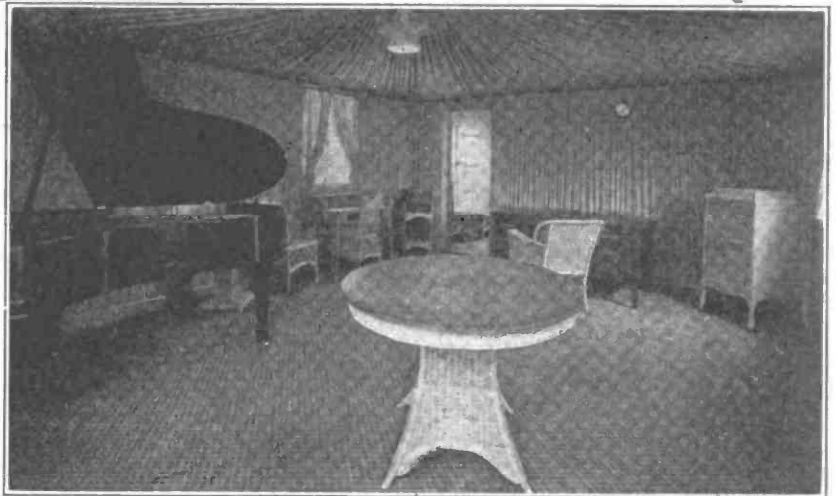

Fig. 5. KFDB Studio

somewhat new principle whereby the effect of the natural period of the diaphragm is eliminated.

### ELEVEN NEW STATIONS

Eleven more broadcasting stations, to function on a 360-meter wave, are announced by the Department of Commerce:

- Adler's Music Store, Baker, Ore.
- Alabama Polytechnic Institute, Auburn, Ala.
- Amarillo Daily News, Amarillo, Tex.
- Louisiana State Fair Assoc., Shreveport, La.
- Meier & Frank Co., Portland, Ore.
- Paramount Radio Corporation, Duluth, Minn.
- Rathert Radio & Electric Company, Cresco, La.
- The Fair Corporation and the Chicago Daily News, Chicago, Ill.
- Bishop N. S. Thomas, Laramie, Wyo.
- Waterloo Electric Supply Company, Waterloo, Ia.
- West Texas Radio Company, Abilene, Tex.



500 Watt Western Electric Radio Telephone Equipment in the Wanamaker Broadcasting Station at Philadelphia, Pa., by Means of Which Music From the Wanamaker Grand Organ Has Been Heard at Berkeley, Calif., and San Juan, Porto Rico.

# LETTERS TO THE EDITOR

## Proper Procedure in Calling

Sir:

Many amateurs, especially those operating C. W. or I. C. W. types of transmitting equipments, seem to pay no attention to the Regulations covering the proper procedure in calling and signing off. Article XXV provides that "The call shall comprise the signal — . — . — the call letters of the station called transmitted *three* times, the word from, (de) followed by the call letters of the sending station transmitted *three* times." (Article XXV, Regulations of the London Convention, Pg. 33, Radio Laws and Regulations.)

The system for answering the call is precisely the same, except the call of the station answering send its call only once, followed by K, the invitation to transmit.

The CQ signal is also permitted, and is substituted for the call, or answer, as may be pertinent in an individual case.

Now, I would be very glad to know by what process of reasoning, or other mental gymnastics the larger number of C. W. and similar station operators perform when they send countless calls, a half dozen DE signals, and sign off anywhere from six to a dozen times, and then often repeat the whole process over again, *without pause* or interval.

I have been informed that several operators "thought" that C. W. stations were entitled to such privileges, as they usually had trouble in calling, owing to their sharpness of tuning. Such ideas, thoughts, or other hazy notions are entirely erroneous, and C. W. stations are no more entitled to call endlessly than are any other classes of stations. They are all actually governed by the Regulations, equally, and should abide by them.

In other words, no stations, C. W. or otherwise, shall call, according to law, in any different manner than that set down by the above-mentioned paragraphs.

Respectfully,

D. B. McGOWN,  
Asst. Radio Inspector.

Oct. 24, 1922.

## The Passing of the Spark

Sir: May I take this opportunity of replying to "A Reader" and "Belligerent Ham," and many others who have not put their thoughts in writing? For I am sure that many, many of the genus "Ham" feel as these two.

Both of the above letters remind one of the drowning man grasping at the proverbial straw. They have read the handwriting on the wall and they fear its consequences. But I believe there need be no fear. The spark is going to pass,—the sooner the better for all concerned—although during the long winter evenings one will miss the note of a really good spark set.

The spark must go as the open-muffled motor in cities has gone. It simply does not belong any more, except as "A Reader" points out, on ships for the purpose of calling assistance when in distress, and the chopper may beat it out there. The spark has outlived its usefulness. Now it is close to becoming a nuisance, not only to the broadcast listener, but to the amateur as well.

Undamped sets may crowd together in a limited waveband and handle traffic—lots of it. How much traffic can you handle with a 1 kw. spark going half a mile, even ten miles away, if you are anywhere near its wave? Very little, if any, I am sure. Half

a dozen, perhaps more, C. W. transmitters that have been working DX satisfactorily, must leave their messages on the hook while one spark, only one, mind you, clears his traffic. Is that fair, Mr. Spark, to keep everyone waiting while you get off your messages? I think it rather selfish. Change your spark "trans" into a C. W. "trans" (G. M. Best will be glad to tell you how), make your "OT" into a C. W. inductance, go out and sell newspapers for the cash to buy a tube or two, put in some sort of a well-filtered d.c. arrangement, and work *with* the C. W. man and not against him!

"C. W. is no good," you say—"Sparks handle practically all the traffic!"—"Most of the C. W. reports are heard, not worked." My answer is, "Look up your back numbers of 'QST' and turn to the Traffic Section." I don't think you need any more convincing argument than last month's traffic report. And the season has hardly commenced!

You don't think low-powered C. W. is reliable. If not how is it that when 6ZAC calls 6ZAF all ZAF has to do is say "i ga"? "But that is on 375 meters," you say. All right, then, can you handle two-way traffic with 3ALN the way 6XAD does on 20 watts? Can you shoot three messages straight to 4BF in mid-summer? Can you— But I could go on and on with such instances. Yes, they are remarkable, but before very long such records are going to be commonplace and on power input way under 1000 watts.

Now as to the matter of interference with broadcast reception. "A Reader" has expressed himself much better than "Belligerent Ham." Mr. "Ham" admits that he can hear sparks a mile away when he is tuned to 360 meters, but when his bulb is oscillating the spark causes practically no annoyance. True, but do you know what you are doing to Mr. Novice who lives on the corner and is listening to the same DX broadcast station? You have constituted of your receiving set a perfectly good heterodyne and Mr. Novice cannot understand why there is such a squeal on the said station's wave. Also, you have spoiled the quality of your own reception by having your bulb oscillating, and the modulated wave from the transmitter is distorted.

Due to the wise heads who formulated the Pacific Plan, we have averted, forever I hope, the potent wrath of the broadcast listener, and verily his strength is huge. Let us abide rigidly by the Pacific Plan, and stamp out the ignorant ham who disregards it as we poison the gophers in our gardens, for, like the gopher, he will destroy our flowers if he is allowed to continue.

About the a.c.-C. W. set. Mr. "Reader" is right about their interference-causing qualities. They do cause a great deal of interference locally, but not on 360 meters, and they are not causing irate broadcast listeners to write to their congressmen that the amateur should be eliminated. Also I believe that following the development of the synchronous rectifier for high-powered C. W. stations we will have less of this a.c.-C. W. QRM. It is perfectly possible to filter the d.c. from a synchronous rectifier and use it for voice. 6EN has definitely proved this.

Mr. "Belligerent Ham," I do not believe that the average person does know that you are only too glad to relay messages for him and he will undoubtedly be interested, but the only way to retain this interest is to deliver the message. We are all glad to relay messages, but how many of us deliver the message to the addressee? Very often, too, a relayed message consumes greater time in

arriving at its destination than does the mail, hence the good we do the novice, apart from the novelty of sending a message by radio which soon passes, is practically nil. Frankly, we are of very little service to him.

Mr. "Reader," you are right in saying that radio is a utility and a convenience. The government of these United States is to secure the greatest good to the greatest number. Now there is no question but that there are a far greater number enjoying broadcasts than there are Amateurs. In order to hold our place we must do something to justify our existence, and in so doing we must not interfere with the pleasure of the broadcast listener. No, I hold no brief for the broadcaster, but I do know that it lies within the power of the broadcast listening public to put us out of existence. That we must not allow! Never! We must hold together and defend ourselves, leaving no loophole in our armor. I greatly fear that the spark transmitter is the Achilles heel of amateur radio.

We are doing our country a service and we must let the public know it. That service is this—We are preparing ourselves to be the nerves of our Army and Navy in the time of a national emergency. Without communication, and especially radio communication, the greatest army and the strongest navy would be powerless. My task in the last war was instructing men in radio communication and I know that radio operators cannot be made in a day. You know it too. If you really want to be of service to your country and justify your existence as an amateur, grab the next chance you get to go to one of the summer training camps and take up Signal Corps work, or join the Naval Reserve. You will never realize how much good it will do you until you have tried it.

In conclusion let us remember these few points and observe them: We must justify our existence (Not forgetting that the American Indian was the first in this country as was the amateur on the air). We must not offend those who have it in their power to put us out of existence. We must hang together; and CARRY ON!

BROOKE SAWYER, 6XAS,  
First Lieut. Signal Reserve Corps.  
South Pasadena, Calif.

## The Other Side

Sir: May a long-suffering "novice" break into your columns in answer to "A Belligerent Ham" and "A Reader" whose letters appeared in your November issue?

Just where these correspondents get the idea that sparks do not interfere on 360 or 400 meters I do not know. Nor do I understand how anyone who has ever tuned a receiving set can take such a ludicrous position. If they know anything at all about radio, they know that sparks *do* interfere. I wish they could tune-in with me at almost any hour of any day or night. They would get a practical demonstration of spark interference.

As to the fault being in the receiving station, I frankly admit that single-circuit tuners are used in a large proportion of "novice" stations. But this, mostly, is the "novice's" misfortune rather than his fault. At any rate, it is the present condition and can not be brushed aside, for the "novice" can no more afford to change from single-circuit to something better than the spark air-hog can afford to change to C. W. Yet "A Belligerent Ham" and "A Reader" want

*Continued on page 108*

# NEWS OF THE RADIO CLUBS

## HARMONY AT SAN DIEGO

By 6XAD

"Peace: a state of quiet; freedom from disturbance; harmony between persons or parties . . . ." Thusly does friend Webster define that elusive thing, commonly known as . . . "peace"!

For some time there has been a sort of friction in the Southland—centering in and about the charming city of San Diego. It has been lamentable—for it involved many operators in that locality. "Good men—tried and true"—were drawn in the vortex of *un-rest*, and—as a direct resultant—the night airs became jammed and efficient work on the air was rather more by accident than anything else!

Through the courtesy of The Anthony Co., Ltd., of Los Angeles, Major J. F. Dillon, Lex Benjamin, W. W. Lindsay and the writer sallied forth from Los Angeles in a splendid Packard twin-six—on a certain cheerful day in October—bound for the southern city.

'Deed and it was a wonderful drive! Hon. Macdonald, Chief Operator at KFI, conned the speeding land ship! 'Nuff sed! At times we barely hit the highest spots in the long, long road!

The courteous hospitality with which we were welcomed will e'er be remembered by me!

Dragged-out details are always wearying! Hence—suffice it to say that Major Dillon, as Radio Inspector-in-Chief of the 6th District, made a masterly speech at the especial meeting of San Diego amateurs that had been called for the occasion. It was brief—to-the-point—and explained the situation in even less than the proverbial nutshell! Major Dillon strongly advocated PEACE, and he subtly let it be inferred that if PEACE did *not* ensue . . . . .!

And he was right!

The air—the *ether*, if you like—is NOT for any *one* body of men! It is a medium that is used for the inter-exchange of signals between ANY men—in the U. S.—provided that in the transmission of signals, the laws of the U. S. are obeyed!

The idea that any dis-affected group of operators can, because of some fancied—and FOOLISH!—little grievances among themselves, so "glom" the air that no one can work with any degree of satisfaction—is, to say the least, ridiculous! Jealousy in both sexes of the human race is—alas—one of the chiefest factors of human misery! Is it not then a GREAT pity that this same demon should enter into the otherwise harmonious life of *radio operators* in the Southland?

There are two Eminent Medicos in San Diego—each with his "following" of amateurs. Far be it from me to even attempt to dissect their "differences"—BUT: I would beg of them to bury the rusted, old hatchet! I would beg of them to remember the good cause of *efficient radio*! I would say—here-with—to both of them:

Gentlemen! — — — FORGET IT!"

There are tales without end—in San Diego! (And many tales that have no *beginning*—that I could discover!) These do not spell "efficiency"! Rather have they a disastrous tendency to . . . disrupt!

Although it is a horrible bromide'ism—I venture to bring to various memories the FACT that:

"United—we stand! Divided—there is Hell to pay!"

This coming radio season promises to be a . . . . . wonder! Shall we, of the Southland, not ALL pull together?

Luis Rexach (40I) of the Porto Rico Radio Club of San Juan, P. R., has put the club on the radio map with his 100-watt C. W. set. Through his station the club established communication with 4FT at Atlanta, Georgia, on September 15th. This station was also copied on September 20th by Gerald Wilson, 6BCA, at San Jose, Calif., while it was sending to 4FT, a distance of about 4000 miles! By means of two other new stations it is hoped to maintain regular traffic schedule. An endeavor is being made to establish communication with amateurs in South America, so "soon we will have traffic from South America to Hawaii through Porto Rico and California. These are not 'chimeras,' but positive things" writes Joaquin Agusty (4JE), president of the club. The club has 302 members, most of whom are studying the club's free course in radio as translated into Spanish by 4JE.

The Long Beach (Calif.) Radio Research Association has undertaken the ambitious project of endeavoring to communicate via radio with the Victorian section of the Wireless Institute of Australia at Melbourne. Arrangements are being perfected by Robert J. Portes, 2500 Elm Ave., Long Beach, and H. Kingsley Love of Melbourne so that these tests may be carried on during December, code transmission to be carried on from Daugherty Field. Other clubs or amateurs interested in this work are urged to write Mr. Portes for complete details. A part of the expense of cabling confirmations is to be raised by a \$5.00 from all participating and a part by a contribution from the Pacific Radio Trade Association.

## PACIFIC PLAN REVISIONS

At a representative meeting of Sixth District radio club members at Los Angeles, Calif., Oct. 14th, the Pacific Plan was amended so as to allow a DX listening-in period from 7:30 to 8:00 p.m. and broadcasting and pure C. W. transmission from 8:00 to 10:00 p.m. daily without interference from spark or I. C. W. transmission. With delegates present from nearly every radio club in California, this action was made unanimous. Resolutions were adopted urging every amateur to observe this courtesy. This action was taken with the understanding that all broadcasting should be discontinued at 10 p.m.

These revisions in the previous plan of ceasing spark transmission between 7:30 and 9:00 p.m. were sponsored by the radio clubs of Central California at the request of Major J. F. Dillon, Radio Inspector for the Sixth District. They represent a compromise between the demands of concert fans that broadcasting continue till midnight and the desire of amateur operators that non-interference broadcasting be continued from 8:00 to 9:00 p.m.

Under their provision all amateur and broadcast transmission will be stopped from 7:30 to 8:00 p.m. in order that Eastern stations may be heard. Each club is to select traffic officers whose duty it will be to warn violators of the rule of no-spark or I. C. W. operation between 7:30 and 10 p.m., that they are in danger of losing their license.

During the convention emphasis was placed upon the necessity for rigid observance of this rule. The hope was expressed that every amateur would voluntarily respect this agreement. Otherwise there is danger of the most rigorous restriction of amateur activities.

## SOME GOOD D. X. WORK

By LESLIE B. GRAHAM

On the afternoon of Sunday, Oct. 1, 1922, Frank M. Curtin (7SZ), Edmund B. Craney (7AEG) and Leslie B. Graham (7BM) made a trip to the summit of Mount Spokane for the purpose of making some radio receiving tests. We left Spokane about three o'clock in the afternoon and arrived at the summit of Mount Spokane, a distance of 35 miles, in time to make camp and erect an antenna before dark.

Our antenna was attached to two trees about 65 feet apart. From one end of the antenna our lead-in was brought in a slanting position to the front wheel of our car. The total length of the antenna, including the lead-in, was about 100 feet. The height of the two pine trees was about 15 ft. It was impossible to obtain a good ground connection and as a substitute we laid out about 65 ft. of rubber-covered wire to the end of which we connected a small coil of bare copper wire. The small coil of wire was buried about six inches in damp ground. Immediately after hooking up the set we gave it a short test during which we heard WGY Schenectady, New York. After this test we finished making camp and ate our lunch.

The receiving set which we used was a single circuit regenerative tuner with two steps of amplification. The following stations were heard during the night:

STATION	LOCATION	TIME
WGY	Schenectady, N. Y.	6:10 P.M.
KFBK	Sacramento, Calif.	8:30
KFAN	Moscow, Idaho	8:45
Avalon	Catalina Island	9:00
9ZAF	Denver, Colo.	9:10
KUS	Los Angeles, Calif.	9:15
KDKN		9:25
KFC	Seattle, Wash.	9:28
KGG	Portland, Ore.	9:55
8APW	East Cleveland, Ohio	10:08
7LU	Greybull, Wyo.	10:11
7SC	Seattle, Wash.	10:12
9APD	St. Louis, Mo.	10:15
6BXD		10:20
7ZD	Bozeman, Mont.	10:22
KLZ	Denver, Colo.	10:27
4BV	Wilmington, N. C.	10:34
KZN	Salt Lake City, Utah	10:37
KFKA		10:40
CJCA	Edmonton, Alta., Can.	10:45
CFCN	Calgary, Alta., Can.	10:53
6BSA		11:19
7AEA		11:21
7HR	Eugene, Ore.	11:24
9AWM	Chicago, Ill.	11:25
6BEG	Los Angeles, Calif.	11:28
9AMQ	Kansas City, Kan.	12:03 A.M.
9AOG	Lawrence, Kan.	12:10
9CFI		12:19
7GA	Portland, Ore.	12:22
7RA	Seattle, Wash.	12:25
6AVG	San Francisco, Calif.	12:21
3MK	Norfolk, Va.	12:29
6BES		12:31
8BO	Detroit, Mich.	1:01
5D1	Houston, Texas	1:10
7RN	Cashmere, Wash.	1:45
6BUD		1:48
7AR	Portland, Ore.	1:52
6AO	Hayward, Calif.	1:55
8AU	Detroit, Mich.	1:59
9BD	Vancouver, B. C., Can.	2:01
7AD	Seattle, Wash.	2:07
9CBA		2:09
8CW	Pittsburgh, Penn.	2:15
9ABG	St. Paul, Minn.	2:19
6PT	Salt Lake City, Utah	2:26
1HAS		2:34

6ASW	Gonzales, Calif.	2:55
9HCR		2:59
6AED	San Diego, Calif.	3:03
9RF	Denver, Colo.	3:09
6ASJ	Oakland, Calif.	3:24
5UC		3:30
1AH	Norfolk, Mass.	3:38
9DHN	Joliet, Ill.	3:44
9BXT		3:47
9BCF	Fort Dodge, Ia.	3:48
9BTT		3:54
9AB	Chicago, Ill.	3:55
9BX	Chicago, Ill.	3:55½
9BHK	Dallis Center, Ia.	3:56

All the times given above are Pacific time. The total number of stations heard during the night was 62, which we believe to be a record for one night's work. The elevation of Mount Spokane is approximately 5,800 feet.

We broke camp about four o'clock in the morning and returned to Spokane. As yet we have been unable to verify all of the calls heard, but we expect to hear from all of them very soon.

## SOME STILL BETTER RECORDS

By HOWARD A. COOKSON

While enroute from San Francisco to Honolulu as operator on S. S. *China*, I listened in on 200 meters with a detector and one-step a. f. amplifier and logged the Eastern calls heard as follows:

October 22—449 miles west of San Francisco for China: 5PX, 9BED, 9ANQ, 9AWM, 9CXP, 9DHB.

October 23—845 miles west San Francisco: 5BN, 7ZB, 7EN, 7NY, 7AEM, 7RI, 8SP (Fairmont, West Va.), 8XE (State College Pa.) calls 9GK, 9BED, 9DBL, 9AJH, 9DXN, 9AXU, 9PN, 9BJL, 9BIZ, 9XE, 9ZAF, 9BDS, 9FM, 9ZN, 9XM, 9GK, AD7. (Hear 8XE and 9GK Chicago working all evening.)

October 24—1210 miles west San Francisco: 5ZA, 5CV, 5EO, 5ABH, 7BK, 7DP, 7SC, 7TQ, 8AIO (East Pittsburg, Pa.), calls 6KA, 8BWA (Akron, Ohio) calls CQ, 8YU (Dayton, Ohio) calls CQ, 8NB (Rochester, N. Y.) calls 9??, 9DK, 9AWN, 9BDS, 9AOG, 9CKM.

October 25—1602 miles west San Francisco: 3BLF (?), 4HH (Tampa, Fla.), 4BV (Wilmington, N. C.) calls 9CNS, 5HA, 5ZA, 5NK, 5EO, 5SM, 5EK, 7ADF, 7RN, 7SC, 8XE (State College Pa.) calls CQ, 9BJ (Chicago), 9BK (Chicago), 9BJL, 9AXD?, 9CMK, 9CNS calls CQ all night, 9AWM calls 5EK, 9ZAF, 9AYI, 9BCY, 9AUL, Qsa with 1CMK, 9BDS, 9ZN, 9BDE?, 9GK (Chicago) copied working with an "8". Mag says "Want you here often sig 9DKB" 9GK very consistent and QSA.

October 26—1963 miles west San Francisco: 5XAD (Orange, Texas), 9XM (Madison, Wis.) very Qsa and clear. Copied the following "9XM test 9XM test pse card fm any stn beyond 1200 miles from Madison, Wis., test de 9XM Qrx for amateur NA 9XM." Several other "Nines" heard but unable to read acct strong DC induction from ship's generator.

October 27—Honolulu harbor.

Copied 8AQO all evening. 8AQO is at Cazenovia, New York. I copied the following: "8AQO test Cazenovia New York pse crd 8AQO test 8AQO test amateur 8AQO test Cazenovia New York test 8AQO test 8AQO at Cazenovia New York 8AQO test 8AQO" . . . Sigs quite QSA and clear.

Figures from the bridge give Cazenovia 5100 miles from here. Also copied 9AL

# Central California Broadcasting Schedule---Effective Nov. 1, '22

**San Francisco Bay District**  
Daily Except Sunday  
KUU—9:00 to 10:00 A.M.—Examiner  
KFDB—10:00 to 11:00 A.M.—Merc. Trust Co.  
KZY—11:00 to 12:00 A.M.—A. P. Rad. Sup. Co.  
KLS—12:00 to 1:00 P.M.—Daily News—(Warner Bros.).  
KDN—1:00 to 2:00 P. M.—Fairmont Hotel.  
KFDB—2:00 to 3:00 P.M.—Merc. Trust Co.  
KSL—2:00 to 3:00 P.M.—Emporium. (Except Wednesday)  
KUU—3:00 to 3:30 P. M.—Examiner.  
KPO—3:30 to 4:30 P.M.—Hale Bros.  
KDN—4:30 to 5:15 P.M.—Fairmont Hotel.  
KUU—5:15 to 6:45 P.M.—Examiner.  
KZM—6:45 to 7:00 P.M.—Hotel Oakland.  
KLX—7:00 to 7:30 P.M.—Oakland Tribune.  
—7:30 to 8:00 P.M.—DX Listening-In Period.  
KFDB—9:00 to 10:00 P.M.—Merc. Trust Co., with program furnished through co-operation of Pacific Radio Trade Association.

**SUNDAY**  
KUU—9:00 to 10:00 A.M.—Examiner.  
KLX—10:00 to 11:00 A.M.—Oakland Tribune.  
KPO—11:00 to 12:15 A.M.—Hale Bros. (Radio Church).  
KLS—12:15 to 1:00 P.M.—Daily News—Warner Bros.  
—1:00 to 2:00 P.M.—Open Time.  
KUU—2:00 to 4:00 P.M.—Examiner.  
—4:00 to 5:00 P.M.—Open Time.  
KUU—5:00 to 5:30 P.M.—Examiner.  
KRE—5:30 to 7:30 P.M.—Hotel Claremont—Berkeley Gazette.  
AGI—8:00 to 10:00 P.M.—Presidio (420 meters).  
KFDB—8:00 to 8:30 P.M.—Merc. Trust Co.  
KDN—8:30 to 10:00 P.M.—Hotel Fairmont.

**MONDAY**  
KPO—8:00 to 9:00 P.M.—Hale Bros.  
**TUESDAY**  
KLX—8:00 to 9:00 P.M.—Oakland Tribune.  
**WEDNESDAY**  
KUU—8:00 to 9:00 P.M.—Examiner.  
**THURSDAY**  
KJJ—8:00 to 9:00 P.M.—Rad. Shop, Sunnyvale.  
KRE—8:00 to 9:00 P.M.—Hotel Claremont—Berkeley Gazette.  
(On alternate weeks)  
**FRIDAY**  
KDN—8:00 to 9:00 P.M.—Hotel Fairmont.  
**SATURDAY**  
KSL—8:00 to 9:00 P.M.—Emporium.  
KLS—8:00 to 9:00 P.M.—Daily News—Warner Bros.  
(On alternate weeks)

(Toronto, Canada) and 9GK (Neenah, Wis.).

8AWP (Syracuse, N. Y.) was also heard but was unable to copy.

5ZL (Little Rock, Ark.) and 9AWM (Sleepy Eye, Minn.) also heard.

9YF (location unknown) heard working with 9YU.

It might be interesting to note that my partner, Mr. Van Auken, read 6CC (Gridley, Cal.) ten feet from the phones at 6 P.M. our time while it was still daylight.

I did not log the "Sixes," but will do so west of Honolulu. I heard almost all of them every night. 6KA came in 1900 miles of San Francisco, more QSA, than KPH.

We leave Yokahama homeward-bound Dec. 5th. I will listen on 200 meters from 3:30 to 6:30 a. m. San Francisco time.

**Inland Stations**  
Daily Except Sunday  
KQW—1:00 to 2:00 P.M.—Herrold Lab. San Jose.  
KFBK—3:00 to 4:00 P.M.—Kimbal-Upson, Sacramento.  
KWG—4:00 to 5:00 P.M.—Portable Wireless, Stockton.  
KJQ—5:00 to 6:00 P.M.—Gould, Stockton.  
KFBK—6:00 to 6:30 P.M.—Kimbal-Upson, Sacramento.  
KXD—6:30 to 7:00 P.M.—Modesto Herald.  
KVQ—6:30 to 7:30 P.M.—Hobrecht, Sacramento.

**MONDAY**  
KXD—8:00 to 9:00 P.M.—Modesto Herald.  
KJQ—9:00 to 10:00 P.M.—Gould, Stockton.  
**TUESDAY**  
KWG—8:00 to 9:00 P.M.—Portable Wireless, Stockton.  
**WEDNESDAY**  
KQW—8:00 to 9:00 P.M.—Herrold Lab., San Jose.  
KVQ—8:00 to 9:00 P.M.—Hobrecht, Sacramento.  
KJQ—9:00 to 10:00 P.M.—Gould, Stockton.

**THURSDAY**  
KFBK—8:00 to 9:00 P.M.—Kimbal-Upson, Sacramento.  
**FRIDAY**  
KWG—8:00 to 9:00 P.M.—Portable Wireless, Stockton.

**SATURDAY**  
KVQ—8:00 to 9:00 P.M.—Hobrecht, Sacramento.

**SUNDAY**  
KJQ—10:00 to 11:00 A.M.—Gould, Stockton.  
KXD—1:00 to 2:00 P.M.—Modesto Herald.  
KWG—2:00 to 3:00 P.M.—Portable Wireless, Stockton.  
KVQ—6:00 to 7:00 P.M.—Hobrecht, Sacramento.  
KFBK—8:00 to 10:00 P.M.—Kimbal-Upson, Sacramento.

## 6ZAC SETS NEW "WORKING" RECORD

By CLIFFORD J. DOW

All world's records gone to smash! October 29th, Sunday a.m., 6ZAC worked 9AWM, Lloyd Berkner, Sleepy Eye, Minn., for an hour, exchanging three messages, and compliments, etc., without once asking for repeats from either station.

The distance is roughly 4,400 miles. 9AWM was using one 250 watter on one-third power, radiation 3.5 amps. ZAC used one 50 watter, with a.c. on plate, radiation 4 amps. There was NO CALLING for half an hour at a time. We merely called once or twice, and excellent QSO was maintained throughout the hour. The time was between 5:40 a.m. and 6:40 a.m. CST, it being daylight half an hour before we said "GM" and went to breakfast. QSS negligible from both stations.

The second world's record to be broken was the longest relay by amateur stations that has yet been put across. A message was received from 6CC, to 6ZAC, saying: "Greetings from amateurs half way round the world. (Sig) 40I." The message originated in Porto Rico, and was QSR'ed via ARRL stations across the U. S., and via 6CC to 6ZAC.

# Exceptional DX for September and October

By Major Lawrence Mott, (6XAD)

It is not with any intent of bragging that I publish the following list—and a remarkable one, for *this season of the year*—but it is given to the great amateur fraternity in order to prove, indubitably, that DX can be achieved through heavy QRN, and despite adverse conditions! I would furthermore compliment—and thank—my kind correspondents from the far-distant places, and I would also call attention to the fact that many of them have received me after the sun

8CGX, 8CKO, 8CQH, 8CYU, 8DAE, 8KG, 8ON, 8TG.  
 (8AB)—2-steps, (8HJ), 8GP—detector, 8JP, 8SE—detector, 8VH, 8VQ, (8VY), (8ZO)—detector, (ZY), 8AM, 8ADN, (8AQF), 8ATX, (8AWP)—aerial only—no ground, 8AXN, (8BCY), 8AZD, 8AGO, 8BEP, (8BHE), (8BKE), 8BMQ—detector, 8BNZ — detector, (8BUM), (8BUX), 8BVD—detector, 8BZD, 8CAK—detector, 8CAL, 8CEF — detector, 8CNB, 8CXF,

4BV—Saskatchewan, Canada (Loreburn).  
 4DY—Winnipeg.  
 9AL—Toronto.

AND:  
 report, dated Oct. 10th, from Savannah, Ga., H. E. Hansen. Operator on a coast-wise ship, that he heard 6XAD when his vessel was 60 miles off the port of Savannah, Ga.—in full daylight!

R. L. Byrum, State College, Raleigh, North Carolina.



Map Showing Some Work by 6XAD

had risen in the East. Another salient point is that many of the stations reporting me used only a detector!

And . . . . . in *working* the many DX stations I used NO steps of amplification—either!

The list:

- 1AKG, 1BBK—1-step, 1BKA, 1CJA, 1CPN, 1BYN.
- 1CBO, 1BOQ, 1GV, 1LA.
- 2BII, 2BME, 2BUE, 2BZJ.
- 2CJA, 2BRC, 2AFV—detector, 2KF, 2LT, 2AEH—detector, 2ASC—detector, 2AJF—detector, 2AGH, 2APD—2-steps, 2AJC, 2AWF, 2BYC, 2CIN—detector, 2CJE—detector.
- 3AGZ, 3ARO, 3AWH, 3BIJ, (3BLF), 3BSF, (3CC), 3GC, 3OH.
- 3BLU, 3CC, 3JJ—detector, 3PZ, 3OT—1-step, 3ADU, 3ANJ, 3XM, (3BHM)—1-step, 3BIT, 3BLF—1-step, L. Causy-Norfolk-Va.—detector.
- (4BF)—1-step, (4BV), 4FZ—detector, 4JY, 5AC, (5EL), 5HK, 5KC, 5FI—detector, 5AEC, (5TM).
- (5QS), 5TM, 5RH, (5UO), (5TM), (5ZA), 5VO, (5XAD), 5XV—detector.
- 6BMY—detector, 6ZAC.
- (7LR), 7OE, (7JF), 7LR, (7ZU).
- 8AAW, 8ADH, 8AFY, 8AGZ, 8ASL, 8AWB, 8BEO, 8BFM, 8BKM, 8BXC,

8CKO, (8CPX), 8CTP—detector, 8CZN—detector, 8CZZ, 8YAE—detector, (8HJ), (8AQZ), (8AGF), (8ASV), (8AXM), (8CAZ), 8BQB, 8CZZ, 8BMM, 8BO.

9AOE, 9BKJ, 9BXT, 9CAH, 9CIP, 9CJC, 9CNS, 9CP, 9CTF, (9CTR), 9DKB, 9DWK, (9EI).

9AXA, 9DFB, (9EI), (9ZAF), (9YAJ), (9DR), (9EI), 9FK, (9FM), 9FV, (9PS), 9UC — detector, (9UU), (9ZN), 9AFN, 9AAP, 9ADL, 9AFN, 9AJH — detector, (9APS), 9APW, 9AQR, (9AWM), (9AYS)—detector, 9AYH, 9BIK, 9BIJ, 9ZN, 9FM, 9BFT, (9GK), (9DF), (9DL), (9KP), (9UU), (9ZL), (9AFB), (9AJM), (9AJS), 9ALF, (9AMB), 9ADL, 9AMH, (9AWL), (9AYH), 9BCF, (9BDS), (9BED), (9BHD), (9BJV), (9BII), (9BLC), 9CBF, 9ALF, (9DZY), 9CXP, (9CTR), 9DNC, (9DZY), (9DLY), (9CNS), (9WDR), (9XAF), (9XAQ), 9BDS, 9BHD, (9BJV), 9BQW—detector, 9CDV—detector, 9CVL—detector, 9DJO, 9DMH, 9DSD, 9DVL—detector, 9DVV—detector, 9DZY, 9DTE, 9DTU, 9CLZ, 9CTR, (9XAC).

(“AD7”)

CANADIAN:

- 3KO—Chatham, Ontario.
- 3GN—Ingersoll, Ontario.
- 3DS—Kitchener, Ontario.

## Another DX Record

Sir: A short time ago I sent you a list of calls for the “calls heard” column in your magazine. In that list was included the call of 4OI. Since that time I have obtained the address of 4OI and have communicated with him. Radio 4OI is Mr. Luis Rexach of San Juan, Porto Rico, (Box 319).

I copied 4OI at 8:10 P.M. (Pacific time), September 20th, 1922, when he was sending with 4FT (Mr. Donald McParsley, Box 113, Wilmington, N. C.). Radio 4OI uses 2 50-watt tubes and gets 3.5 thermocouple amperes, using tube rectifiers in a Radio Corporation circuit; his antenna is 100 feet high. For reception I used a single circuit tuner with one tube only (it happened to be a Cunningham amplifier tube used as a detector) and a 1-wire antenna 20 feet high and 100 feet long.

The time and details of reception, such as time, wave, etc., have been positively confirmed by Mr. Rexach. Radio 4OI is about 4000 miles from my station. This is a record in amateur reception that has only been surpassed by the reception and transmission records of 6ZAC, Mr. Dow of Hawaii.

Yours very truly,  
 GERARD WILSON, 6BCA.  
 363 South 11th St., San Jose, Calif.

# DIGEST OF RECENT RADIO PATENTS

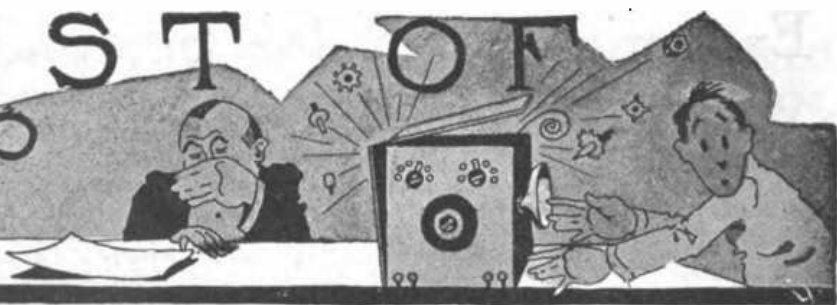

Prepared by White, Prost & Evans, Patent Attorneys, San Francisco, who have been particularly active in the radio field for many years, and from whom may be obtained further information regarding any of the patents listed below.

**L. B. Turner, Pat. No. 1,422,013: July 4, 1922. Thermionic Apparatus applicable for Wireless Telegraphy and other Purposes.**

A combination of two tubes, 1 and 2, is arranged so that the plate 13 of one is connected through a high resistance to the grid 12 of the other, and plate 14 is similarly connected, through a signaling source  $e$ , to the grid 11. By proper adjustment of the resistances  $R_1$ ,  $r_1$ ,  $R_2$  and  $r_2$ , it is possible to obtain high amplification, due to the cascade arrangement from one tube to the other which serves to reamplify the signals. Any suitable translating device may be connected across any of the resistances.

**H. W. Nichols, Pat. No. 1,422,822: July 18, 1922. Radio Transmission.**

In order to modulate the waves transmitted by the antenna circuit 1-2-3, supplied by a source 16, without the necessity of handling all the modulating energy at a transmitter 14, this transmitter is made to affect the impedance of the output circuit of one or more thermionic relays 7 in parallel. The output circuit is connected in parallel to a portion of the antenna circuit, so that that portion of the energy which may pass through this parallel path is modulated. The output circuit of the bank of amplifying relays 7 cannot be directly placed in the antenna circuit due to the high impedance of this output circuit, and therefore the parallel arrangement is used. In this way only a very small power

is handled at the microphone or other transmitter 14.

**David G. McCaa, Pat. No. 1,423,345: July 18, 1922. Signaling Method and Apparatus.**

Continuous oscillations to be detected in an absorbing circuit  $A$  are made to combine with oscillations locally produced by an oscillator tube  $V$  so as to influence a translating device  $T$  in the output circuit of the tube. The oscillations produced by tube  $V$  are preferably of the same frequency as that received, and detection depends upon the alternate neutralization of the two sources of oscillations, and cumulation, at audio frequency. This effect is produced by the aid of a transformer having coils  $P_1$  and  $P_2$  inductively connected to coil  $S_2$  in the tube circuit, and a commutator  $D$  arranged when rotated to make either  $P_1$  or  $P_2$  active. These are oppositely wound so that when said  $P_2$  is active, the energy transferred to  $S_2$  is in phase with that generated by tube  $V$ , but if coil  $P_1$  is active, the energy so transmitted is  $180^\circ$  out of phase.

**Claude R. Fountain, Pat. No. 1,424,091: July 25, 1922. Radioelectron Oscillator.**

A dynatron arrangement of large capacity is described, in which the electrodes 12, 14, 15, 16, 17 and 13 are annularly arranged and in such a way that a vacuum may be maintained between the inner cylindrical electrode 12 and outer cylindrical electrode 13. For purposes of cooling, also, and for

vacuum sealing, the entire device may be immersed in an insulating liquid, such as oil. The source of electrons is the series of filaments 14, 15, heated from the terminals of a power transformer 6. Bombardment by the electrons of the outer cylinder 13 causes secondary emissions. The extent of the bombardment is controlled by electrodes 12 and 16 which are in circuit with the transmitting system 5, 9, 10, 11, as well as by the potentials applied to electrodes 17 and 13 from the d.c. source 1-2. The resulting oscillations are impressed on the oscillating circuit 4-7.

**L. F. Fuller, Pat. No. 1,424,141: July 25, 1922. Electrical Oscillation Generator.**

An arc generator is described, in which there is a carbon cathode 3 and a metal anode 4, operating in an atmosphere of hydrogen. The anode 4 is in the form of a hollow tube through which cooling fluid may be passed, and due to its smooth outline, the liability of carbon projections forming thereon of appreciable extent is materially reduced.

**E. H. Loftin and H. H. Lyon, Pat. No. 1,424,365: August 1, 1922. Radiosignaling.**

A directional receiving system is described, in which use is made of groups of antennae 1, 2, 3 having divergent directions. These antennae are low, and may in fact be buried conductors, and those in each group are of

*Continued on page 100*

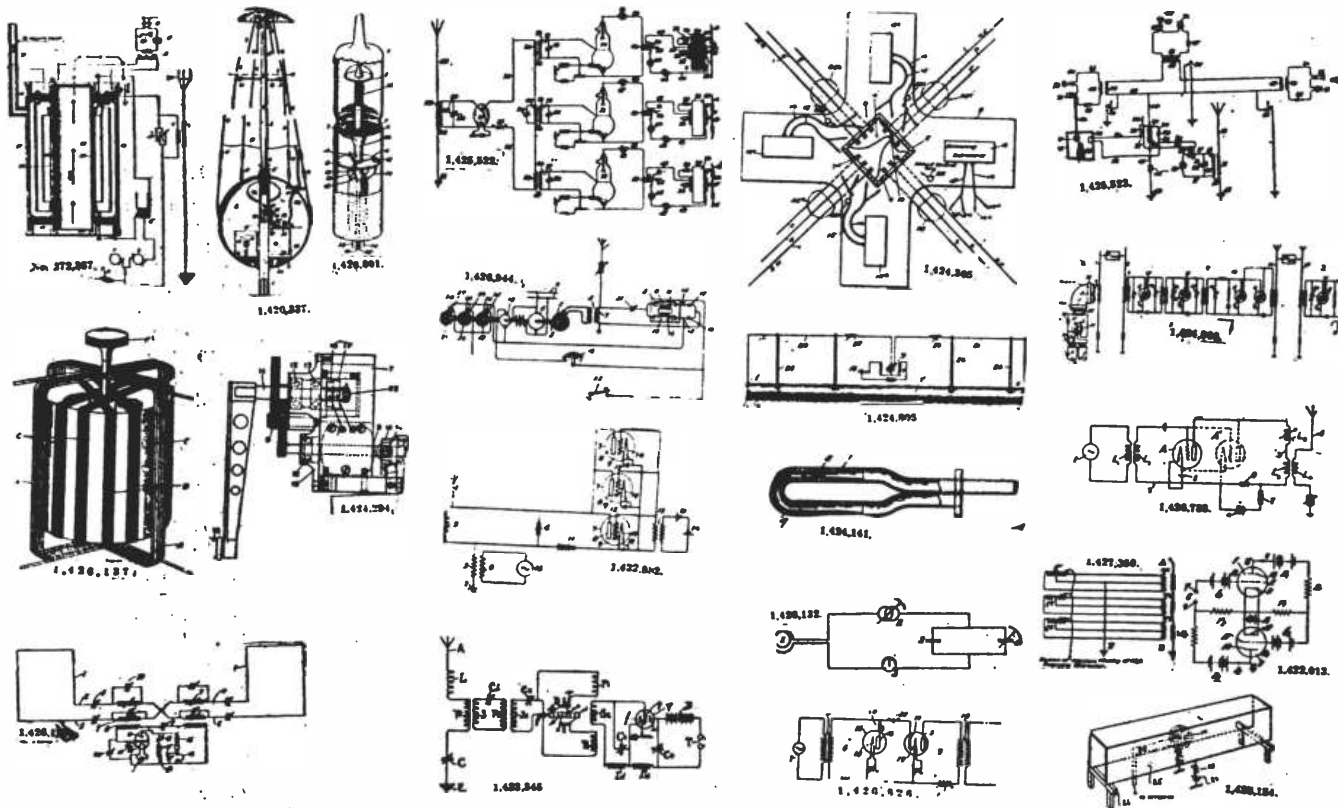



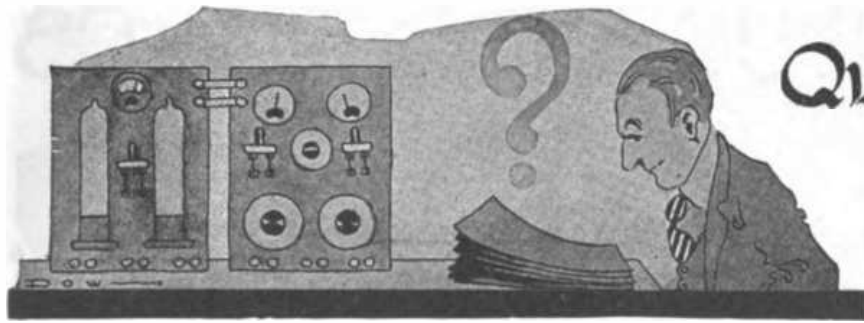

# Queries & Replies

## on C.W. practice

by

### Gerald M. Best,

#### Technical Advisor.

Questions submitted for answer in this department should be typewritten or in ink, written on one side of the paper. All answers of general interest will be published. Readers are invited to use this service without charge, except that 25 cents per question should be forwarded when personal answer by mail is wanted.

I have a number of British tubes, Type LT-2, which I wish to use in a radio frequency amplifier circuit, as I understand that these tubes are particularly well suited for radio frequency work. Will you please publish a circuit using three of these tubes as radio frequency amplifiers, to work with a loop and suitable detector?

H. H. B., Vancouver, B. C.  
The circuit is shown in Fig. 1. The LT-2 tubes burn at an exceptionally low

left in the circuit, as it is of very low resistance, and will not interfere with the operation of the tuned circuit.

Please publish a circuit using three honeycomb coils, five tubes, two radio frequency and two audio frequency transformers, using variable condensers.

G. M. F., Los Angeles, Calif.  
The circuit you wish is shown in Fig. 3. You will have to use more than three honeycomb coils if you wish to take advantage of the regenerative feature for

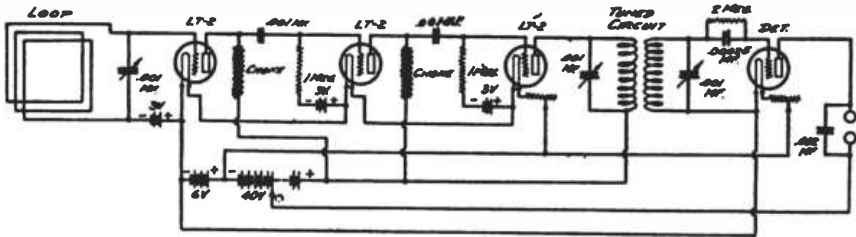

Fig. 1. Three-Tube R. F. Amplifier Circuit

filament voltage and current, and since you probably wish to use the amplifier in connection with your regular receiving set, which has American tubes, I presume, I have shown the filaments of all three tubes connected in series, across six volts. A filament rheostat of 3 ohms or more should furnish sufficient resistance to control the tubes without danger of burning them out. The chokes should be large enough to keep all radio frequency out of the B battery circuit; 1/2 to 1 henry will do.

How many turns on a 4 in. tube will be necessary to cover a wavelength range of 150 to 500 meters with an .001 mfd. condenser, as shown in the sketch. Will it be necessary to short the milliammeter when using the buzzer?

R. W. K., San Francisco.

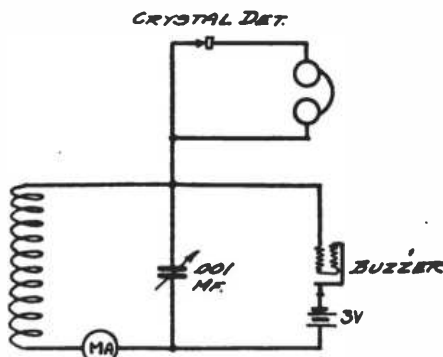

Fig. 2. Wavemeter Circuit

The wavemeter circuit you sent is shown in Fig. 2. Fifty turns on a 4 in. tube, with taps at the 15th and 30th turns will enable you to cover the range you desire. The milliammeter can be

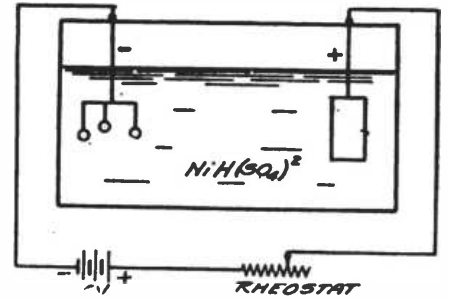

Fig. 5. Nickel Plating Battery

across the secondary is not necessary when you already have a variometer in the grid. A .002 mfd. phone condenser is necessary, in shunt across the primary of the first audio frequency transformer.

Kindly advise as to the best method for nickel-plating some brass fittings, with a dull nickel-plate.

C. F. J., Brooklyn, N. Y.

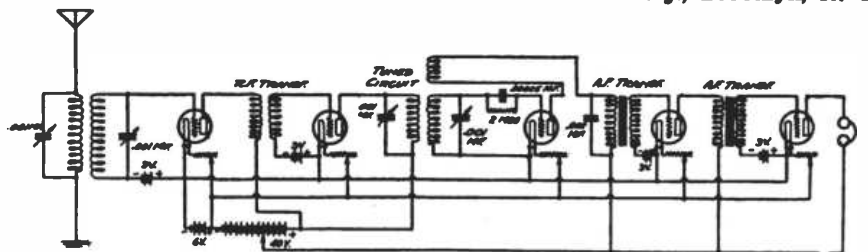

Fig. 3

receiving C. W. telegraph stations; five are shown in the sketch.

I am enclosing the hook-up of my set. Please tell me why it does not receive signals from a distance, or loudly.

J. C. S., Santa Clara, Calif.

Separate B batteries, as you have shown them, are not necessary. One battery will do the work. You have provided no means of making the grids of your amplifier tubes negative with respect to the filaments. This can be accomplished as shown in the corrected sketch, Fig. 4. A variable condenser

In a wooden or non-metallic container place a saturated solution of nickel ammonium sulphate, known commercially as double nickel salts. As shown in Fig. 5, the anode is of pure nickel and the cathode is the article to be plated. The current flowing through the battery depends upon the size of the piece to be plated. Brasswork should be thoroughly cleaned before plating. You had better consult a nickel plating handbook at your nearest public library.

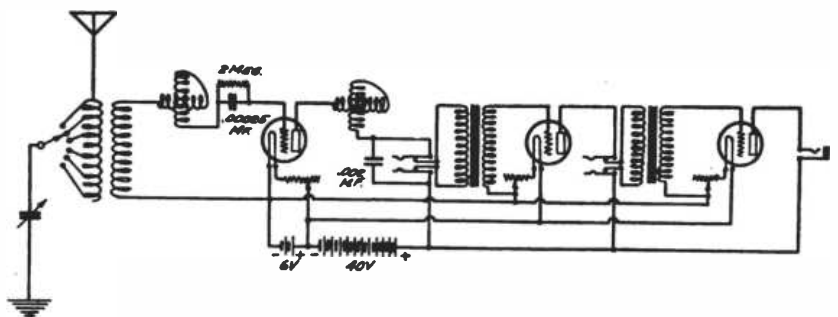

Fig. 4

# NEW APPARATUS AND SUPPLIES FROM THE RADIO MANUFACTURERS

## THE BRADLEYOMETER

Another application of the compression resistance principle has been made by the Allen-Bradley Company, Milwaukee, in the Bradleyometer, a new potentiometer embodying graphite discs operating under pressure. In placing the Bradleyostat filament rheostat on the market, the Allen-Bradley Company had applied a principle they have been using for twenty years in the manufacture of rheostats and motor starters for industrial purposes. The smooth current control obtainable with this type of resistor was especially desirable for radio circuits, where the sensitive units require the finest of adjustment.



The Bradleyometer



Rauland "All American" Shielded Transformer

In the Bradleyometer this same idea has been utilized with the result that a potentiometer with all the desirable control characteristics of the Bradleyostat, is available.

Two columns of discs are assembled in the porcelain container, each column with a separate and independent pressure plug extending through the top cover plate. The pressure knob rotates through 180 degrees, and through a special shaped cam applies pressure to one column in one direction of rotation and to the other column in the other direction. As pressure is applied to one of the columns the pressure is released on the other.

The resistance of a column of the discs varies with the pressure, so that the action of the Bradleyometer is to decrease the resistance in one column and simultaneously increase the resistance in the other column. The total resistance of the two columns remains constant, as in any wire-wound poten-

tiometer, while a connection between the two columns serves the same purpose as the slider of a wire potentiometer.

The Bradleyometer controls the resistance gradually as the pressure is increased or decreased on the discs. This provides for an even balancing of the potential in the plate or grid circuits, wherever the Bradleyometer may be connected. No foreign noises are introduced into the circuit. The Bradleyometer accomplishes the full range in control with 180 degrees rotation of the knob. It is made in 200 and 400 ohm capacity.



Bryant Radio Receiver

## BRYANT RADIO RECEIVER

A receiver of unique design, consisting of detector and two stages of audio frequency amplification, is announced by the Bryant Radio Co. of Palo Alto, Calif. As may be noted from the illustration, the panel is set at a 45 degree angle, thus adding to the compactness of the set and to convenience in tuning. Tuning is accomplished by rotating one dial and change from one to two stages of amplification by turning a switch. All connections are at the back and the "B" battery is inside. The circuit is a special one developed by the Bryant engineers to eliminate spark signals, this set being intended primarily for broadcast reception in the home.

## A NEW COUPLED CIRCUIT TUNER

The Atwater Kent Manufacturing Company of Philadelphia have developed a new tuner with the idea of simplifying operation and still retain maximum performance. It takes the place of a variometer and variocoupler in a coupled-circuit receiver, accomplishing the results with but one adjustment.

Tuning of antenna circuit is unnecessary. Three binding posts are provided on the back for adjusting the instrument to the particular type of antenna being used. Once this adjustment is determined, no further adjustment is necessary for broadcast reception. It is unaffected by body capacity at the dial knob. All insulating parts are sturdily made of moulded condensite.

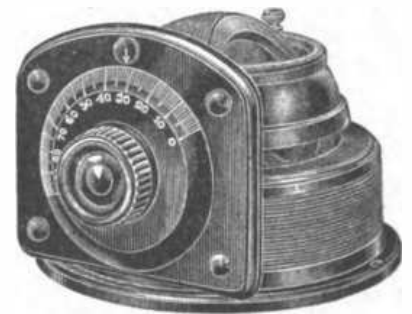

New Coupled Circuit Tuner

The manufacturers state that at their summer laboratory in Kennebunkport, Maine, using this tuner, in conjunction with a standard circuit and 2 stages of audio frequency amplification, Broadcast Concerts have been clearly received from Porto Rico, Davenport, Iowa, Chicago, and many other distant points. The instrument can be used with a crystal detector and the crystal detector later discarded when a more pretentious set is desired.

## SHIELDED A. A. TRANSFORMERS

One of the hits of the Chicago Radio Show was the completely shielded "All-American" transformer made by the Rauland Mfg. Co. of Chicago. This embodies a standard transformer, designed to give maximum amplification without distortion, completely shielded in a nickel-plated glass case. The shielding is claimed to make it possible to mount the transformers close to one another without induction disturbances or howling.

This transformer is made up in three ratios: 3-1, 10-1, and 5-1. The first named is recommended for the third and fourth stages, although the others can be used for as high as three stages without howling.



Los Angeles Radio Show

### LOS ANGELES RADIO SHOW

Los Angeles held its first Radio Show October 9th to 15th. In point of interest on the part of the trade, it proved very successful, there being represented more than fifty firms, manufacturers and dealers. The exhibits were located conveniently on the large roof of the Arnold Building and were housed in very attractive booths. Working demonstrations of apparatus were most interestingly afforded by most of the exhibitors and, although there was very little in the way of actual novelty, the standard equipment shown was of wide variety and excellent character.

is invaluable to anybody who wants to "roll his own."

Radio Catalog No. 58 R from the Electric Appliance Co. of San Francisco is intended only for dealers, as this house sells to the trade. It lists the products of standard manufacturers. This jobber maintains a technical service department ready to assist the dealer in building his business.

The Mazda Radio Mfg. Co. of Cleveland, Ohio, has issued a series of leaflets illustrating and describing their high-grade radio parts which include vernier condensers, resistance pile type rheostats, sockets, plugs, jacks, knobs and dials.

amateurs as 2ZL, 1ZE, 8ZG, 9ZG, 5ZA and 6XAD form the subjects of three chapters. Complete details are given for a 5-watt V. T. transmitter with electrolytic rectifier. Brief account is given of commercial C. W. work and considerable general information for the amateur. This text brings into convenient form the facts that have hitherto been available only in radio periodicals. The treatment is descriptive and commentive. Theory and mathematics have been eliminated so that any amateur can gain an excellent idea of the accepted practice in C. W. transmission.

*Amateur Radio Directory and Call Book*, edited by Walter B. Spiegel—116 pages, 6¼x9½. Published by Radio Directory and Publishing Co., 45 Vesey St., New York City. Price \$1.00.

Herein is a complete list of all amateur stations in the United States, including special license and broadcasting stations. By its use the name and address corresponding to any call letter may be located. It is, of course, invaluable to the transmitting amateur.

*The Armstrong Super-Regenerative Circuit*, by Geo. J. Eltz, Jr.—52 pages, 6¼x9½, paper cover. Published by Radio Directory and Publishing Co., 45 Vesey St., New York City. Price \$1.00.

The ambitious amateur looking for an understandable treatment of the theory and operation of a super-regenerative receiver will find this book more helpful than most of the material yet published. This treatment is based on the fact that the action of the circuit is dependent upon the negative resistance being greater than the positive. Three cases are discussed in detail: variable negative, variable positive and simultaneous variation of both positive and negative. The hook-up and explanatory notes are given for each case, together with excellent pictures of a receiver employing the second method. Variometer control is used in each case. The text is concluded with a comparison of advantages and disadvantages of each method and a list of parts necessary to construct the sets.

*How to Retail Radio*, by the editors of *Electrical Merchandising*—226 pages, 5½x8. Published by McGraw-Hill Book Co., New York City, and for sale by Pacific Radio Publishing Co., San Francisco. Price \$2.00.

Radio is such a highly specialized line of electricity that the would-be retailer has to make a special study of the subject to insure success. Here is a book for the dealer, a book telling of tested plans, methods and policies in selling radio equipment. It covers such topics as financing, location, store equipment and arrangement, buying radio, getting customers, advertising, displaying goods, training salesmen, demonstrations, installation and service, "hook-ups," speeding up sales, establishing a club room for amateurs, business records, overhead, turnover. It admirably fills its purpose.



Exhibit at Los Angeles Radio Show. The Kolster Decremeter on Center Showcase Is Available for Amateur or Commercial Testing Purposes.

The exposition was held under auspices of Southern California Broadcast Association, the Radio Trade Association of Southern California and Southern California Radio Association. Largely owing to the fact that the principal reliance for publicity was upon mention of the Show in broadcasting programs, there was very little attendance of the general public, most of the visitors being those who possess receiving sets and are accustomed to listen-in on the daily broadcasts.

### BOOK REVIEW

*Modern Radio Operation* by J. O. Smith—138 pages 6x9. Published by Wireless Press, Inc., New York City, and for sale by Pacific Radio Publishing Co., San Francisco. Price \$1.75.

This is a book for the transmitting amateur, especially the one who is interested in C. W. telegraphy and telephony. The author is widely known as 2ZL, a pioneer in C. W. work. Starting with general comments on broadcasting, he soon gets down to detailed descriptions of the condenser transmitter, "constant current" modulation and such stations as WDY, WGY and WJZ. The chapter on receiving equipment gives typical circuit diagrams for crystal and tube sets, including the Armstrong super-regenerative. Tube fundamentals and characteristics, types of C. W. transmitters, and the work of such

### NEW RADIO CATALOGS

Essex Mfg. Co. of Newark, N. J., have issued a loose-leaf catalog of parts used in assembling crystal and tube receivers, together with complete tuner, detector and amplifier units.

The Handbook of Radio Facts from Frank A. D. Andrea of New York City supplies the technical explanations of design and construction of efficient radio receiving sets. It



# You

**KENNEDY  
EQUIPMENT**

*KENNEDY  
Regenerative Receivers  
are licensed under  
Armstrong U. S. Patent  
No. 1,113,149 and are sold  
by good dealers everywhere*

will want a  
**KENNEDY**

*Regenerative Receiver  
some day—why not now?*

Kennedy Regenerative Receivers, because of their superior construction and because they correctly apply the principle of inductively coupled circuits, are the standard by which all other radio receivers are judged. *It is well to remember that it always is safer and cheaper to buy the best.*

WRITE FOR OUR LATEST BULLETIN C-3

*Address our nearest office*

This Bulletin supersedes all others and illustrates and fully describes all Kennedy Radio Equipment.

**THE COLIN B. KENNEDY COMPANY**

INCORPORATED

**SAN FRANCISCO**

**U. S. A.**

**SAINT LOUIS**

Tell them that you saw it in RADIO

# HOMCHARGE



## Your RADIO BATTERY for A NICKEL

ENJOYABLE RADIO CONCEPTS and maximum receiving range are obtained only when your battery is fully charged. Don't be bothered with the inconvenience and expense of taking your battery to a service station every few days for recharging. The New



has been designed especially for this purpose. It charges your "A" or "B" battery over night without removing from the living room—gives taper charge—cannot harm your battery in any way. Simplicity itself. Only two wearing parts, replaceable after several thousand hours' use for One Dollar.

### AN ORNAMENT FOR YOUR LIVING ROOM

Beauty has been combined with utility in the NEW RADIO HOMCHARGER DE LUXE. The body is beautifully finished in rich Antique Mahogany—the base and fittings in a handsome dull gold. Equipped with rubber feet, it cannot mar polished surfaces. It harmonizes with the finest living room.

### OVER 50,000 HOMCHARGERS IN USE

50,000 users have heartily endorsed the HOMCHARGER. Beware of imitations. When buying insist on obtaining the genuine, which bears our registered trade name, HOMCHARGER.

Furnished complete. No extras to buy. Price \$18.50 (\$25.00 in Canada) at all good dealers, or shipped prepaid upon receipt of purchase price.

Booklet illustrating the NEW RADIO HOMCHARGER DE LUXE in actual colors is FREE for the asking. Send for your copy today.

DEALERS - JOBBERS: Over 150,000 HOMCHARGERS will be sold this Fall and Winter. Send for your copy of "HOMCHARGER Business Builders" and see how you can get your share of this business.

### CAUTION

When buying a Rectifier insist upon the following:

1. SELF-POLARIZING feature, otherwise your battery may be ruined through reverse charging.
2. AT LEAST FIVE AMPERES CHARGING RATE, otherwise it will require several days to full charge your battery.
3. UNDERWRITERS' APPROVAL, otherwise in case of fire your insurance may be void.

The HOMCHARGER is the only Rectifier at any price which combines the above three NECESSARY HOMCHARGING features.

## The Automatic Electrical Devices Co.

117 West Third Street Cincinnati, Ohio

Largest Manufacturers

of

Vibrating Rectifiers in the World

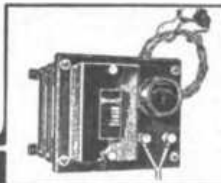

### BRANCH OFFICES

New York Chicago Pittsburgh  
Detroit Dallas  
Philadelphia Los Angeles  
Baltimore Minneapolis Atlanta  
St. Louis New Orleans

TYPE "A" FOR WALL MOUNTING

OVER 50,000 IN USE

## CALLS HEARD

Continued from page 42

(8boe), (8bpx), (8bqd), (8bqs), 6zac, (nrre), (7bb), 7dp, (7iy), (7hm), 7jf, (7jw), (7lu), 7mw, 7na, 7nn, 7oe, 7ox, 7qn, (7sc), 7th, 7tn, (7tq), 7wm, 7xc, 7xi, (7zb), 7zk, 7zo, 7zu, (7aca), (8cf), (8ib), 8iv, 8nb, 8yd, (8bfm), 8bfp, 8bke, 8bxh, (9ac-Can.), 9cp, (9dp), 9kp, 9ps, 9yi, 9yu, 9zn, 9afd, 9ajp, (9amb), 9ami, 9anf, (9anq), (9aog), 9aon, (9aps), (9apw), 9aul, 9awm, 9ays, 9ayu, 9bed, 9bek, 9bxc, (9cna), 9cuc, 9dtm, 9xq, 9yaj, (9zaf), kfi, kfc, knz, kfay, wgm.

By 7TH, Walla Walla, Wash.

Can.—Spark: 4ec, 5dx, (9bd), (5ca). O. W.: (4bv), (5ct).

U. S.—C. W.: 5di, 5vn, 6ak, 6cc, 6cp, (6ev), (6ea), (6eb), 6en, 6ft, 6gx, 6qm, 6rm, (6nx), 6aat, 6aag, 6aeh, 6ajh, 6alu, 6apw, 6aqw, 6arb, 6atc, 6atq, 6awt, 6bcd, 6bcj, (6bic), 6bjc, 6bko, 6bm, 6bo, 6bpx, 6bpc, 6bpc, 6bpc, 6brf, 6bsp, 6bum, 6bun. Spark: 6ac, 6ic, (6iv), 6qk, 6qr, 6tc, 6vx, 6amk, 6ang, 6ani, 6ala, 6alv, 6aju. C. W.: (9ps), 9amb, 9ani, 9anq, 9adg, 9avz, 9awm, 9bqw, 9bxa, 9bxt, 9ccv, 9cfy, 9dtm, 9zaf. All stations hearing my 10 watt C. W. ple QSL.

By 600, 88 Peralta Ave., San Francisco

8vy, 8asv, 9wd, 9zn, 9amb, 9aap, 9bjl, 9cns, 9dtm, 9xq, 9zaf, 7lr, 7rn, 7zn, 7zb, (6ap), (6apw), 6cc, 6zh, 4hh. All C. W. on 1 step amplifier.

By 6ZY, Honolulu, Hawaii

4bq, 4bx, 4eb, 5di, 5jw, 5kc, 5ks, 5px, 5zh, 5za, 5aat, 6abx, 6abu, 6ak, 6ath, 6aol, 6awt, 6apw, 6ahq, 6ajh, 6asj, 6ar, 6arb, 6alu, 6atg, 6bxy, 6brx, 6br, 6bar, 6bqc, 6bpx, 6bql, 6bun, 6bzc, 6bsa, 6bfe, 6cu, 6cp, 6cc, 6cp, 6en, 6ec, 6ea, 6eb, 6ex, 6gx, 6jd, 6ka, 6mbc, 6mdm, 6pi, 6xad, 6xwi, 6zh, 6zx, 6zm, 6ze, 6za, 6zq, 6zg, 7kj, 7lu, 7mf, 7xc, 7zo, 8ab, 8ah, 8alt, 8abr, 8bg, 8bfm, 8bpl, 8bas, 8bda, 8ib, 8kg, 8oh, 8ok, 8ow, 8aap, 9ac, 9aja, 9awm, 9ap, 9ars, 9aps, 9aog, 9alt, 9ao, 9amb, 9ags, 9bbf, 9bno, 9bbl, 9bec, 9bed, 9bjv, 9bzi, 9cns, 9cpb, 9dhd, 9dam, 9dq, 9dpl, 9dg, 9dtm, 9dph, 9ps, 9qu, 9zaf, wuba.

Spk: 6ahf, 6en, 6up, 6aju, 6bfa, 7aa.

By 6ZAC, Walluku, Maui, T. H.

C. W.: 2fp, 2gk, 4bq, Can. 4bv, 5acf, 5nk, 5px, 5af, 5ij, 5za, 5zh, 5zaw, 6ak, 6aeh, 6ajh, (6abx), 6ahq, (6asj), 6aar, 6avd, 6brf, (6bsa), 6bpf, 6bpx, 6bqc, 6bqd, 6bju, 6bro, (6cc), (6ca), 6ec, (6en), 6cu, (6cp), 6jd, (6ka), 6ku, 6pi, 6rd, 6rm, (6tq), (6xj), 6xad, 6zb, 6zf, 6zx, 6zaf, (6zg), (7ac), 7ay, (7ot), (7xi), 7zb, 8bum, 9amb, 9anq, 9aph, 9aog, 9awm, 9bey, 9bjl, 9dam, 9gk, 9mf, 9xq, 9yaj, 9zaf.

Spk: 5za, (6ex), (6aqu), 6tc, 9yak.

By 7ADF, Montesano, Wash.

C. W.: 4bv (Can.), 5ck, 5ct, 5cn, 5et, 5dic, 5mc, 5td, 5va, 5sa, 5xp, 6aal, 6aat, 6abm, 6abu, (6abx), 6afw, 6ahp, 6ajf, 6aps, 6arf, 6ars, 6atc, 6atg, 6atq, 6awe, 6awp, 6awt, 6bcd, 6bcj, 6ber, 6bic, 6biw, 6btb, (6bum), 6ak, 6bc, 6bg, 6br, 6bo, 6bq, 6cc, 6cu, 6dj, 6ea, 6gf, (6gr), 6ku, 6po, 6pi, 6uw, 6vm, 6vz, 6xj, 6zf, 6za, 6zu, 6zx, 7aad, 7abh, 7abx, 7aca, (7aem), 7afw, 7agx, 7bk, 7bj, 7bx, 7dp, 7ic, 7iy, (7ke), 7la, 7lf, 7lr, 7lu, 7mf, 7mu, (7ot), 7sy, (7th), 7tn, 7tq, 7zb, 7zf, 8bu, 9amb, 9amg, 9aps, 9awm, 9bed, 9bja, 9bqq, 9bwl, 9cns, 9pl.

Spk: 5sp, 6abc, 6abk, 6acr, 6ala, 6aix, 6amk, 6ark, 6atq, 6bcw, 6bjc, 6biq, 6bmd, 6bua, 6al, 6aq, 6cc, 6cv, 6dp, 6fr, 6gr, 6lu, 6po, 6rd, 6to, 6tv, 6uw, 7aba, 7bb, 7fn, 7ge, 7jc, 7jf, 7jw, 7mf, 7mu, 7qf, 7rc, 7vf, 7wp, 7yw, 7zg, 7zk, 7au, 9bd (Can.), 9ge, 9uu.

Fone: kfs, kfck, kfcd, kys, kfg, klc, kfde, klt, kmo, klf, knz, kdyl, cheq, kfbc, kbb, cfch, kdif, kfam, kdys, ksz, ksv, kdsl, and many others.

By 78N, Seaside, Ore.

C. W.: 5za, 5xad, 5di, 5ek, 5px, 5nk, 5ak, 5qi, 5ae, 5fv, 6ag, 6ak, 6cc, 6gy, 6lv, 6xz, 6rm, 6pi, 6rd, 6gd, 6en, 6wr, 6ec, 6zx, 6lk, 6vf, 6nx, 6eo, 6lh, 6xh, 6bh, 6cu, 6oo, 6uw, 6gf, 6ep, 6bz, 6gr, 6abx, 6alu, 6ajh, 6aa, 6bcj, 6bqg, 6aor, 6beg, 6bpf, 6bqc, 6bcd, 6aat, 6bqd, 6awt, 6ber, 6bum, 6bmd, 6ahq, 6bql, 6asj, 6avv, 6aqw, 6atq, 6zac, 6bdw, 6bmx, 6atj, 6btb, 6anp, 6brf, 6aod, 6abr, 6bdb, 6avn, 6bic, 6xaa, 6blu, 6bjj, 6aly, 6bnt, 6xad, 6atc, 6auu, 6bin, 6bud, 6aol, 6aae, 7ng, 7iz, 7ru, 7nn, 7zy, 7dx, 7tq, 7zb, 7aw, 7sc, 7dp, 7bi, 7wm, 7to, 7pf, 7th, 7lw, 7ad, 7bk, 7jw, 7hm, 7ot, 7rn, 7ri, 7aft, 7ad, 7aem, 7afw, 7yaf, 8zk, 8dx, 8asv, 8omi, 8aim, 9gk, 9yu, 9yf, 9zaf, 9bed, 9zaa, 9xq, 9dy, 9awm, 9ami, 9ars, 9xam, 9yaj, 9cns, 9dam, 9aqm, 9bhd, 9zag. Can.—4og, 4bv, 5bq, 5ct.

Spk: 6qr, 6dd, 6oh, 6ex, 6gr, 6cc, 6ic, 6vx, 6lu, 6bua, 6ark, 6abw, 6acr, 6amk, 6akt, 6alv, 6agt, 6bak, 6zae, 6ala, 6bin, 6amw, 6bip, 7of, 7gw, 7tw, 7nn, 7jf, 7oh, 7ba, 7gc, 7ne, 7zu, 7po, 7acn.

Continued on page 64

## MILLION POINT MINERAL

### The Worlds Greatest Radio Crystal

M. P. M. is supersensitive, reproduces from every point on its surface and has record of receiving concerts over six hundred miles.

Ask your dealer for M. P. M. or send 50c for two M. P. M. Crystals, concert-tested and guaranteed.

**M. P. M. SALES COMPANY**

Dept. E 247 So. Central Los Angeles, Cal.

Tell them that you saw it in RADIO

# \$13<sup>60</sup> That's All for a Willard "A" Battery

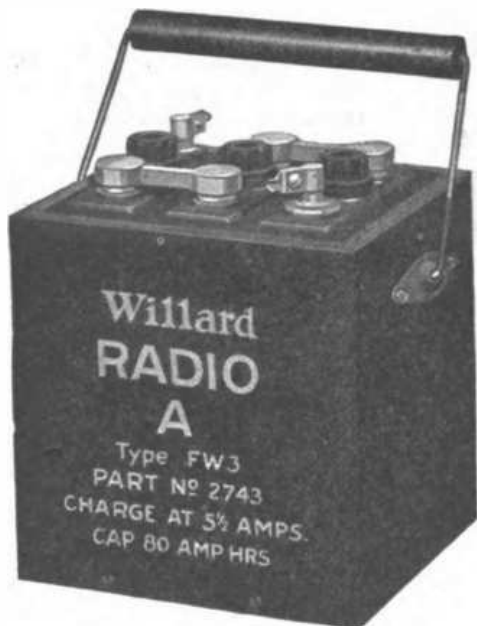

**It's Made in 3 Sizes!**

This new battery—the Willard FW—is of the 6-volt type and made in three sizes, 40, 80 and 110 ampere hour capacity. They are priced as follows: 40 a. h., \$13.60; 80 a. h., \$17.50; 100 a. h., \$22.00. A slight addition to these prices is made in the extreme South and West of the Mississippi.

Here's a Christmas present that will go big, you can be sure—with yourself or anyone else who has a radio set.

It's a genuine Willard "A" Radio Storage Battery at the lowest price for which a Willard Radio "A" Battery has ever been sold.

And when we say genuine Willard we mean just that, for this new battery is fit in every detail to bear the name. We are no less proud of having been able to produce such a good battery to sell at such a low price than of being the makers of the popular Willard All-Rubber Radio Batteries, the last word in radio battery construction.

**Why This is a Real Willard**

It is made in the same plant and by the same men who make the higher-priced Willard batteries for both radio and automobile service, and they bring to it the same care, skill and experience.

It has Willard quality plates, selected wood separators, tested rubber jars, acid-proofed container.

It includes such features as special terminals to insure easily-made and tight connections, special marking for positive terminal; patented rubber gaskets to prevent leakage; a convenient durable roller-type handle, and other advantages.

All Willard Radio Batteries, too, are shipped from the factory dry and fully charged, so that you always get a brand new battery and one that is ready for use just as soon as the acid solution is poured into it.

*Go to the nearest Willard Service Station or your dealer's today and see this new Willard Battery.*

**WILLARD STORAGE BATTERY CO., Cleveland, Ohio**

*Made in Canada by the*

**Willard Storage Battery Company of Canada, Limited, Toronto, Ontario**

# Willard STORAGE BATTERY

Tell them that you saw it in RADIO

## "There's No Place Like Home" To Charge Your Radio Battery

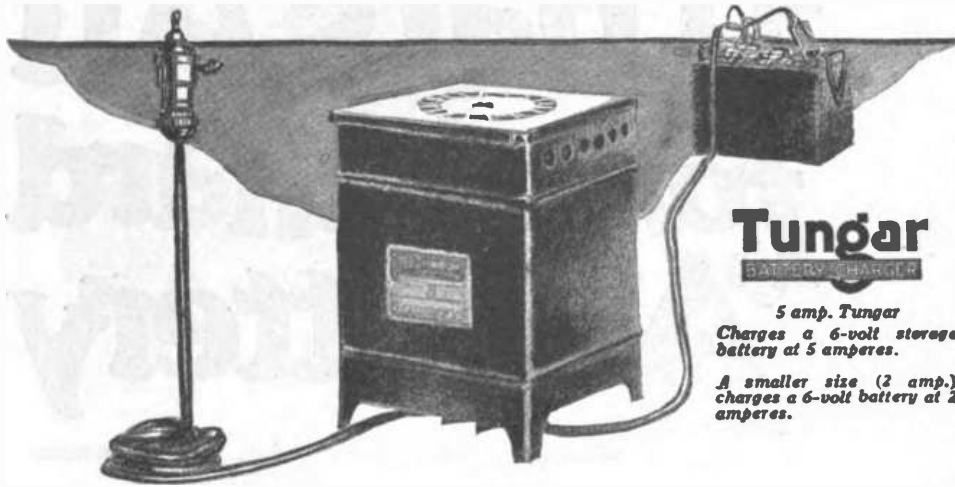

**Tungar**  
BATTERY CHARGER

5 amp. Tungar  
Charges a 6-volt storage  
battery at 5 amperes.

A smaller size (2 amp.)  
charges a 6-volt battery at 2  
amperes.

If you use tubes in your radio receiver you use a storage battery.

If you use a storage battery it must be charged.

### Charge Your Storage Battery at Home with a Tungar Battery Charger

Without taking the battery out of the house—in fact, without moving it at all—you can charge it easily and quickly at a minimum of expense, trouble and lost time.

Isn't this much better than taking the battery to a charging station, leaving it a day or two, paying from 75¢ to a couple of dollars and then carrying it back again?

The Tungar is a small, compact rectifier which connects to any a-c. lighting circuit wherever there is a socket or receptacle and requires no attention while operating. Its first cost is not high and it can be operated by anyone without the slightest danger of injuring the battery. Send for new radio booklet and prices.

Address Merchandise Dept., General Electric Company  
Bridgeport, Connecticut

**General Electric Company**  
General Office  
Schenectady, NY      Sales Offices in  
all large cities      35A-70C

*Special Service to Radio  
Jobbers and Dealers*

## Oregon and Washington Manufacturers' Representatives

We Exclusively Represent Many Leading Manufacturers  
of Standard Radio Equipment.

**WESTERN RADIO DISTRIBUTING CO.**

L. C. Smith Bldg.

Seattle, Wash.

Tell them that you saw it in RADIO

## CHRISTMAS PHANTOMS

*Continued from page 23*

Captain Hamish was oiling the control on his engine-room telegraph. He grinned sociably as Norris came in. He was a pleasant-faced man of forty, with the skin that goes with sailing and a pair of quizzical blue eyes. It was their first cruise together and he liked the unconventional off-handedness of the new operator.

"Well?" he asked.

"You're wanted on the phone," said Norris dryly, with just a hint of a smile. The Captain's eyes narrowed.

"Huh! What's that?"

Norris shrugged.

"Some ass on a radiophone just called you up," he explained. "Refused to give a sine. Got nasty when I asked him for one. Insisted on having you in a hurry." He waited.

The Captain stared at him with open mouth. Then he chuckled.

"Feel all right Bob?" he asked.

Norris flushed.

"Go on," he said. "Rub it in. That's the way I felt when I heard it . . . a voice, two hundred miles off the Mexican coast. He comes in like a hammer . . . not far away . . ."

Something flickered back in the Captain's eyes—something that made Norris wonder. He straightened up.

"All right," he said. "Let's see what this bird has to say."

He led the way down to the operating room. At the door he paused and swept the horizon with keen eyes. There was the yellow haze, the copper rim of the sinking sun, and limitless distance. Nothing more. He stepped inside.

Norris plugged in an extra pair of telephones so that the captain could listen with him. Then he set his generator to humming.

"O-K . . . G-A . . . go ahead . . . WWMQ," he spelled into the placid air. Instantly came the hollow drone of the carrier wave.

"Captain Hamish there?" demanded the voice.

"Yes," Norris answered, on the key.

"All right," ordered the voice, "give him the phones and stay off the air yourself."

Norris swung in his chair. Captain Hamish's face was a study in conflicting emotions, but he nodded and indicated that Norris remove his head-pieces. Norris complied, tapping a brief "I-I" on the key. He was game to see it through.

The Captain stood motionless—listening intently. Norris could hear the voice issuing from the receivers on the table but could not make out the words. The tones were quick and incisive and seemed to be giving orders. Hamish

*Continued on page 48*



**Why Magnavox is the Reproducer Supreme**

OFFICIAL tests with the Oscillograph prove that the Magnavox electrodynamic receiver reproduces incoming wave forms with maximum accuracy.

The Magnavox can be used with any receiving set—the better the set, the more Magnavox can do for you.

When you purchase a Magnavox you possess an instrument of the very highest quality and efficiency.

**R2 Magnavox Radio with 18-inch horn**  
(as illustrated)

This instrument is intended for those who wish the utmost in amplifying power: for clubs, hotels, dance halls, large audiences, etc. It requires only .6 of an ampere for the field. Price \$85.00

**R3 Magnavox Radio with 14-inch horn**

The ideal instrument for use in homes, offices, amateur stations, etc. Same in principle and construction as Type R2. Price \$45.00

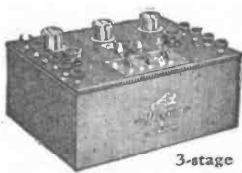

**Model C Magnavox Power Amplifier**

For use with the Magnavox Radio and insures getting the largest possible power input.

2-stage \$ 80.00  
3-stage 110.00

Magnavox products can be had of good dealers everywhere. Write our nearest office for copy of new illustrated folder.



Make it the **GREATER Radio Christmas**

THE gift of all gifts is Magnavox Radio, the Reproducer Supreme—the gift that will mean most to every member of the family—old and young.

Let Magnavox tell you the world's daily news and entertainment—so clearly that voice or music can be enjoyed by all, as though from your own phonograph.

The Magnavox Co., Oakland, California  
New York: 370 Seventh Avenue



**MAGNAVOX**  
Radio  
*The Reproducer Supreme*

Tell them that you saw it in RADIO

*Their "Baby"*

Licensed Under Armstrong U.S. Pat. 1113149

**PRESCO**  
**RADIO**

J. Matheson, Bell Sales Mgr.  
Davenport, Iowa, U.S.A.

Continued from page 46

had grown suddenly white. His eyes were staring.

Suddenly with a cry he threw down the receivers and dashed from the operating room. Norris stared at his retreating back in amazement. Then he grabbed up the head-set. All was silent. Save for the crack of the static there was no sound.

Down below, the ship's telegraph jangled suddenly . . . The *Susan Reynolds* began to veer around, heading inland at twelve knots an hour. Hamish on the bridge . . . !

A shadow flitted over the deck, and a black smudge laid down beside the ship. The operator opened his door and glanced upward. Great billows of smoke were rolling from the short stacks, as the vessel, under forced draught, gathered her heels under her. He caught the change of direction, and the rapid movements of the crew.

Hamish and his stricken face kept coming up . . .

He turned back to his instrument, and calibrated the adjustment for future reference, logging the circumstance among his records. What did it all mean? Whence came this mysterious voice that tore the soul out of a man like Hamish, and sent a tanker veering about on a strange course?

It is no part of a radio operator's job to question a captain. Yet some radio operators possess privileges. Norris, pacing the deck in indecision, suddenly took the bit in his teeth . . .

Captain Hamish was absorbed in a chart, spread out on the table before him. Measuring distances with a pair of calipers, he did not look up as Norris entered. The latter could see that he was still gripped by fear, by a feverish anxiety to get to some place . . . The face of the first officer stopped his tongue. The man was staring at Hamish with a curious, puzzled expression.

Norris closed the door softly and stepped back to the deck. Whatever lay behind, the captain had not talked . . .

The sun was dead astern now!

Only that noon, Hamish had said "all hell" wouldn't keep him from making Callao by the fifth. Now he was going almost dead away from it. Wherefore, reasoned Norris, the voice out of the ether, had represented "hell" or worse. He went back to the radio room.

The second officer dropped in presently, an over-casualness in his manner. Had heard the radio working. Any news? Any excitement? His hands were unsteady as he rolled a cigarette. Norris shook his head.

"No—just testing to see if the old set was working after the blow . . . never know when you'll need it."

Continued on page 50

## "ILLINOIS" THE RELIABLE

CONDENSER THAT IS MADE RIGHT  
AND STAYS RIGHT

	Panel	Cased		Panel	Cased
67 Plates	\$7.00	\$8.50	23 Plates	\$2.75	\$4.00
43 "	\$3.50	\$4.75	13 "	\$2.25	\$3.50

Vernier with single movable plate applied to 13, 23 or 43 sizes, \$2.00 extra.

Above list is for our Regular Style with Knob, Pointer and Scale. We also furnish the Condenser with smooth 3/16 inch staff suitable for Dial at 15c off list.

A 3-inch Bakelite Dial with Condenser, add 50c to list.

Fully Assembled and Tested. IMMEDIATE SHIPMENT.

Money back if not satisfied. Just return within 10 days by insured Parcel Post.

Sent Prepaid on Receipt of Price, Except: Pacific States, Alaska,

Hawaii, Philippines and Canal Zone, add 10c. Canada add 25c.

No Discounts except 5 per cent on orders of 6 or more. Send for Bulletin.

### G. F. JOHNSON

625 Black Avenue

Springfield, Illinois

# CW MANUAL

By J. B. Dow **\$1.00** Postpaid in U. S.

The only complete textbook on vacuum tube transmitters

PACIFIC RADIO PUBLISHING CO.

Pacific Building, San Francisco

Tell them that you saw it in RADIO

# Bradleystat Tests Amaze Radio Engineers

## Startling Effects Revealed by Laboratory Tests

Following are extracts from the unbiased report of the Amorc Laboratories, New York and San Francisco—

*"Tested Bradleystat after 32 hours of continuous burning of tube. Battery voltage dropped from 6.88 to 6.01, but current varied only 2 points, which was unimportant.*

*"We discovered a very important point thereby. As voltage dropped, your device automatically adjusted itself through temperature of discs and thereby maintained better adjustment than any other rheostat.*

*"You have rendered radio a great service with your device."  
(Signed) H. Spencer Lewis.*

Are you getting the benefit of our twenty years of experience with graphite rheostats? Order your Bradleystat, today, for better radio.

**Allen-Bradley Co.**

Electric Controlling Apparatus  
288 Greenfield Ave., Milwaukee, Wis.

Member of the National Radio Chamber of Commerce

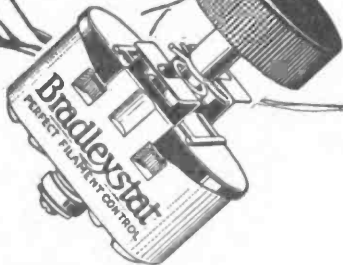

Retail Price  
**\$1.85**  
P. P. 10c Extra

Ask for the Checkered Box at leading radio dealers. If your dealer cannot supply you, please send us his name and we will arrange with him to demonstrate the Bradleystat.



# Bradleystat

REGISTERED

U. S. PAT. OFF.

## PERFECT FILAMENT CONTROL

Tell them that you saw it in RADIO

# Assembled— But Not WIRED

The  
STANDARD  
Idea

## A New Method of Buying Radio Equipment

Buy your radio instruments according to the Standard Idea—a new way and a cheaper way. Our full line of instruments, including the popular Detector and Two-Stage Amplifier and the Multiple Wave Tuner, embody the latest developments in radio practice. These instruments are delivered to you—completely equipped—but not wired. You do the wiring yourself, using our simple diagrams and instructions, and save fully 20% over what you would usually pay for an instrument of this kind.

The STANDARD IDEA is the latest thing in Radio. It saves your money and improves your knowledge of the science of radio. It saves money because it enables our factory to eliminate the costly operation of hand wiring; an interesting job that you can do in your spare time.

**STANDARD ASSEMBLING CO.**  
6 Stone Street New York, N. Y.

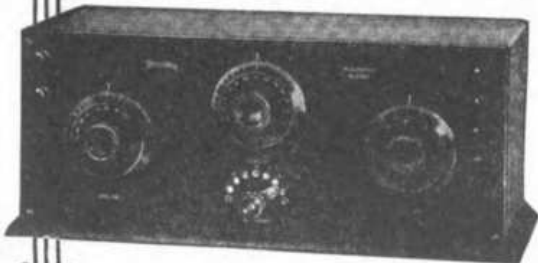

*WRITE TODAY for a description of the various instruments we make and their prices. Ask about our offer to ship any instrument on receipt of one-third the purchase price, subject to refund if the instrument does not come up to your expectations.*

### THE RADIO RUSH HAS STARTED

THE MAN BEHIND THE COUNTER NEEDS HELP. AN EBY SILENT SALESMAN WILL INCREASE YOUR BINDING POST BUSINESS AND ENABLE THE CUSTOMER TO WAIT ON HIMSELF.



INVEST \$3.00 FOR TWO OF THESE ATTRACTIVE BOARDS. THEY WILL PAY FOR THEMSELVES THE FIRST WEEK.

IMMEDIATE DELIVERIES

**THE H. H. EBY MANUFACTURING CO., PHILA, PA.**

Tell them that you saw it in RADIO

*Continued from page 48*

Fencing. Nothing gained. The second officer left after a bit, plainly knowing nothing.

Down in the engine-room, oilers and tenders watched the gages, making swift calculations. They shook their heads. If this continued . . .

Six o'clock. The sun down behind the haze. The black smudge flattening on the water. The boilers straining . . .

Hamish came into the radio room suddenly, coatless. His face haggard.

"Have we any code for work with Fuente?" he demanded, harshly.

Norris shook his head.

"Standard ABC," he said. "Nothing private."

The captain turned away with a gesture of despair. Norris was beside him in an instant, his hand on the other's elbow.

"Anything . . . I can do?"

The Captain lifted a face wrenched with mental pain.

"I'm afraid not, Bob," he grated.

The door slammed between them.

Nothing there. What then . . . ?

The cargo? Oil—direct from the Associated pipes at Richmond. Clearance all according to Hoyle. Nothing contraband. Norris checked back in his mind . . . he had watched the supplies come aboard. Bacon, cased stuff . . . no bootleg. Nothing there. What then . . . ?

The radio offered a possible solution. He cut in on the carrier adjustment again, taking care that his tubes did not betray his position by oscillating . . . turned low, an amplifier in to make up the difference . . . a war trick. Distance stuff . . . static—lots of it . . . miles to the southwest, the crackling smash of cloud-banks.

Nine o'clock. The carrier wave . . . and the voice!

"Susan Reynolds . . . are you in?"

Norris' hand went out. Then he pulled it back, smiling grimly. The cards were his now. Waiting! The call came several times, then . . .

"The damned operator's gone off . . ."

Not spoken to him, or to the transmitter, but in the operating room, to someone else . . . voices, persons talking . . . But where? Silence, as the carrier again went off.

Captain Hamish came in a moment later.

"Anything?" He asked.

"No." Norris lied convincingly. He wanted to be in, must be in. With the Susan Reynolds off course, forced draught, and the Voice loitering in the background . . .

"Let me know . . . if he . . . comes in again."

Hamish went out after this. Norris turned on his tubes.

*Continued on page 52*

# The Tower of Babel will be Sending this Winter

Forty powerful broadcasting stations, all operating on one narrow wave band—that's the situation confronting the radio fan this winter. With the ordinary single circuit it will be like listening in on the Tower of Babel.

The PARAGON three circuit receiver, because of its greatly superior selectivity and sensitivity, can pick and choose between broadcasting stations of about the same signal strength with less than one per cent differential.

PARAGON three circuit receivers are always more satisfactory to operate. This winter any other kind of a receiver is obsolete and practically useless. When you pay out your good money, get a modern receiver—the PARAGON.

Also Manufacturers  
of  
**PARAGON**  
Radio Telephone  
Transmitters  
V. T. Control Units  
Rheostats  
Potentiometers  
V. T. Sockets  
Amplifier Transformers  
Detectors  
Control Dials  
Amplifiers  
Receivers  
Switches  
Variometers

ADAMS-MORGAN COMPANY

2 Alvin Avenue

Upper Montclair, N. J.

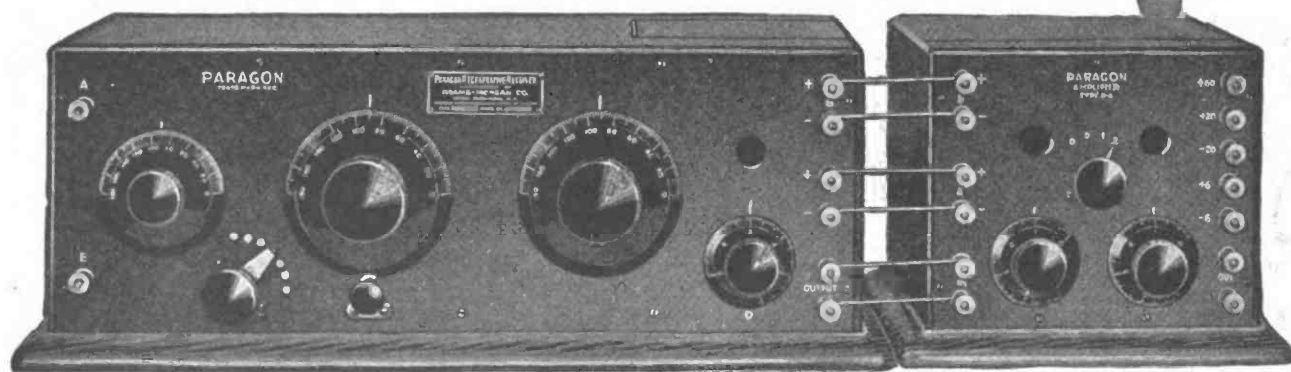

Type RD-5 Regenerative Receiver (including Detector)

Type A-2 Two-Stage Amplifier

(Licensed Under Armstrong Patents)

# PARAGON

Reg. U. S. Pat. Off.

## RADIO PRODUCTS

Tell them that you saw it in RADIO

Continued from page 30

"... Reynolds, are you in, are you in . . . ?" Over and over monotonously.

It was a Federal violation not to answer if one heard. So Norris turned over to the navy length, taking weather from Loma, and logging it against official investigation. There are tricks in every line . . . . For the present, he could only wait. Sometime Hamish must break . . . . no man can grow fear of his kind and carry it. Norris was waiting for that. He heard the watch changing.

Hamish came in—suddenly. He had been drinking. He clung to the door, reeling in the swinging light. Norris flipped on a switchboard light with a green shade. It had a calming effect. Hamish sank into a chair and buried his face in his hands. Norris passed over the cigarettes but the captain shook his head.

"Not yet," he said.

Norris waited. The other's eyes were bleared when he raised his head.

"Bob . . . . I've got to talk . . . to tell . . . somebody. A man can keep bottled just so long, and then the yeast starts working . . ."

The operator nodded. At last!

"I know," he said. "A friend . . . . you know where I stand."

The Captain's hand shot out. Their fingers gripped.

"Has it . . . . have they . . . . ?" He gestured toward the instrument. Norris nodded.

"Three hours . . . constantly. I cut 'em out!" He waited for the explosion. Instead . . .

"I thought so. Somehow, I had a feeling that you were standing between . . ."

His shoulders squared. Norris saw him take a resolve . . . read it silently . .

"Bob!" The Captain spoke with difficulty. "I'm a dog . . ."

"We all are." Norris' tone was equally quiet.

"Yes . . . but—this is different. I'm not fit to wear this uniform." He spread out his hands.

"Quit talking riddles.— Speak your piece," Norris spoke shortly. The other reacted decisively.

"Bob—I've sold out."

"How? Why?"

Hamish jumped to his feet and began pacing the narrow cabin. The swinging light annoyed him and he turned it out. There was only the reflection from the green glass globe.

"I've been driving for Reynolds ten years, Bob. You know the game—low pay, little thanks. Yet I stuck. You ask why? Damn fool I guess. Took a pride in the record I had rolled up. Wireless operators are the same. They'll stick and stick . . . There's no answer save in your own soul. Ten years . . .

Continued on page 34



*Claude L. Yates*

**The SANDMAN'S STORY**

On a Tuska Radio Receiver, every evening you can hear "The Sandman's Story". This delights the children. Later comes entertaining Radio Broadcasting for grown-ups.

Tuska Radio will bring dependable broadcasting into your home. A Tuska Radio Receiver makes a wonderful Christmas Present.

Tuska Radio is substantial, reliable, dependable and recognized. Inspect today at your dealer's.

**THE C. D. TUSKA COMPANY**  
30 Bartholomew Ave. Hartford, Conn.  
Pacific Coast Office, 711 Mission Street, San Francisco, Calif.  
Western Office, 738 W. Monroe St., Chicago, Ill.

**TUSKA RADIO**  
Established 1911

*Catalog Number Four contains Marvellous article on Tuning Receiving Sets 10 cents worth of to you*

## "Chi-Rad" Storage "B" Battery



built for service. Absolutely unequaled in quality and price—half the cost of the cheapest well-made storage "B" battery. Better and cheaper than dry cell "B" batteries because rechargeable.

Will operate a tube approximately 1,000 hours on a single charge. Recharged over night with "Chi-Rad" Storage "B" Battery Charger at a cost of about 5c. No noises or leakage losses with "Chi-Rad" Storage "B" Batteries. Guaranteed for service, or to be returned at our expense. Order your battery NOW.

Write for your free copy of our catalog.

DEALERS: Write for territory on "Chi-Rad" radio parts and sets—the demand's increasing.

- No. 109—"Chi-Rad" Storage "B" Battery, 22½ volt section (mounted) . . . . . \$6.00  
2½ volt section (single cell) . . . . . .50  
No. 109A—"Chi-Rad" Storage "B" Battery Charger . . . . . 1.90

**Chicago Radio Apparatus Co.**  
415 S. DEARBORN ST., CHICAGO

Tell them that you saw it in RADIO

**Peerless Radio Laboratories**

*Manufacturers of Peerless Radio  
Frequency, Receiving Sets  
San Francisco*

November 1, 1922.

RADIO DEVICES Co.,  
693 Mission Street,  
San Francisco, Cal.

GENTLEMEN:

In compliance with your request, we wish to state that until we used the Aerovox we had no end of disappointments owing to the fact that there are so many Radio Frequency Amplifying devices of indifferent make and none seem to stand or give the satisfaction that we derive from the Aerovox in connection with the Variometer that you have been making. These two combined, we feel, are about the most important item of our set. We hope our pleasant business relationship may continue forever.

Yours truly,  
PEERLESS RADIO LABORATORIES.  
By ARTHUR ANNIS, President.  
Arthur Annis/MR

**EDW. M. JONES**

*Insurance Brokers  
SAN FRANCISCO, CALIFORNIA*

October 28, 1922.

AEROVOX CORPORATION,  
47 Kearny Street,  
San Francisco, Calif.

GENTLEMEN:

You will no doubt be interested in knowing the results obtained by me in the use of the Aerovox Inter-Tube Coupler which I installed about a month ago.

I have received the concerts from thirty-six stations in six States and Canada. These were brought in using one stage of radio frequency and one of audio frequency.

I have recommended the Aerovox to many of my friends, who are getting great results from it.

In conclusion I might add that the efficiency of my set has been increased 100% since installing the Aerovox.

Yours very truly,  
Edw. M. Jones.

**BOYLE & KENNA**

*General Insurance  
234 BUSH STREET, SAN FRANCISCO*

November 1, 1922.

RADIO DEVICES Co.,  
693 Mission Street,  
San Francisco, Cal.

GENTLEMEN:

I have been using your Aerovox for the last several months and have experimented with one and two stages of radio frequency amplification. I have used your published hookup with the exception of adding a variometer in the plate circuit.

I have been able to hear stations from San Diego, Cal., to Seattle, Wash., and in the interior, back to Detroit, Mich., taking in Kansas City, Mo.; Davenport, Iowa; Phoenix, Ariz.; Denver, Colo.; Salt Lake City, Utah; Great Falls, Mont., and Reno, Nevada. All of these stations, with the exception of Kansas City, Detroit and Davenport, have been received on the loud speaker.

The results have been so amazingly wonderful that I take pleasure in writing you this letter to advise you of the result.

Very truly yours,  
JAMES R. KENNA.

JRK:M

# AEROVOX

## Radio Frequency Amplification

*is simple enough for the novice, and efficient  
enough for the adept professional*

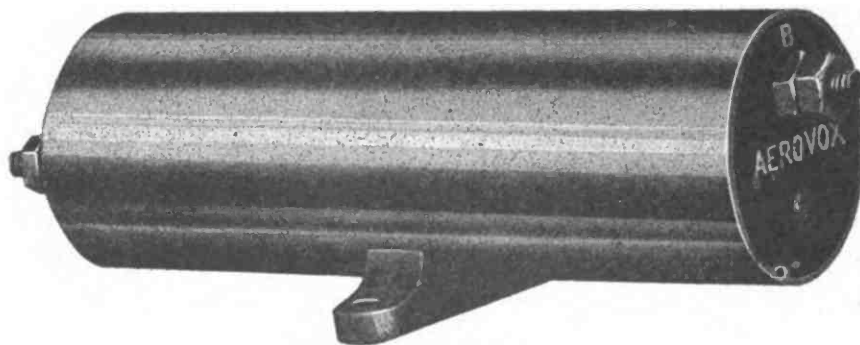

The cut shows what the AEROVOX Inter-Tube Coupler looks like. The letters show what it has done in the hands of others.

*Why not find out what it will do for you?*

*If you cannot get it from your dealer, send his name and the price, \$4.50, to*

**RADIO DEVICES COMPANY - Distributors**

693 MISSION STREET - SAN FRANCISCO

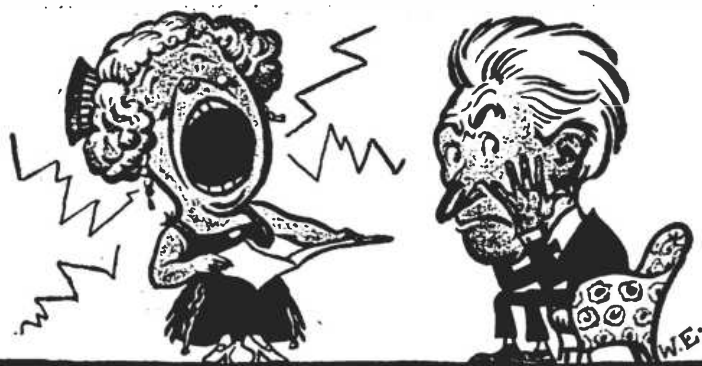

## "Can those shrieks"

**H**OW often have you sat helpless while some amateur Farrar has tried to hit "High C." But when your radio set starts in to show off its shrieking talent you need not go through another ordeal. Just drop in at your nearest radio store and order an Acme Audio Frequency Amplifying Transformer. Hook it up to your detector set and sit back easy. You'll be surprised how clearly and distinctly incoming sounds may be heard. Then, too, the tones are natural. Something usually so lacking in the ordinary set.

You will also want the Acme Radio Frequency Amplifying Transformer because this will greatly increase the range of your set whether it be vacuum tube or crystal detector. Both

Acme Audio and Acme Radio Frequency Amplifying Transformers sell for only five dollars. Your set is not complete without them.

The Acme Apparatus Company (pioneer transformer and radio engineers and manufacturers) are also manufacturers of one and two stage amplifying units, detector units, detector and two stage amplifying units, the Acme Clear Speaker, the Acme phone. Acme C. W. and spark transmitting apparatus offer the amateur an opportunity to not only receive

but send his own messages. For sale at radio and electrical stores or write direct to the Acme Apparatus Company, Cambridge, Mass., U.S.A., or New York Sales Office, 1270 Broadway. Ask also for instructive free booklet on the operation of amplifying transformers, both audio and radio frequency types. You need it.

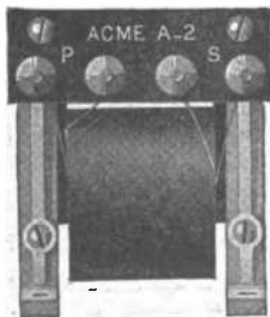

Type A-2 Acme Amplifying Transformer

Price \$5 (East of Rocky Mts.)

# ACME

## for amplification

Tell them that you saw it in RADIO

Continued from page 53

and I banked it against my needs, against a doctor's bill . . ."

He paused and Norris waited—tense.

"I've got a little home on San Francisco Bay, Bob . . . paid for . . . two kids . . . wife. She's ill—fighting for life. It's been a long battle . . . hospitals, specialists. It's taken money. It's going to take more . . . if she wins. The Prentiss line wanted me, but I turned 'em down. I grew up with Reynolds and I felt he would do the right thing. He didn't. The old man might, but the young un's in the saddle now—an efficiency hound. Sees nothing but figures. I couldn't speak anything but sentiment . . . He didn't get me, that's all."

"Who did you sell out to?" Norris' voice was cool, even.

"The Consolidated. They've got big contracts down here. They want every gallon . . . got to have it. Big money. Reynolds refused 'em flat. They tried the underground then. Heard about me—some way. One of their agents met me just after I left Reynolds . . ."

"Well—go on."

Hamish steadied his voice.

"I was sore . . . I listened. Two thousand flat for throwing the cargo sounded pretty big. I could do a lot with two thousand . . . for her. . ."

"What was the plan?"

"I was to snag the Susan Reynolds inshore off Fuente. They were to handle it, from then on. As you know, it's all in barrels . . . they'll float . . ."

He buried his face again. Norris sat silent. The whole dastardly plan was plain now. Hamish was to have wrecked his boat where the Consolidated crowd could salvage.

"Did you see Reynolds . . . personally?" he asked apropos of nothing.

Hamish shook his head miserably.

"Some underling . . . that's what made me sore. I sent in word it was urgent. Came back and said Reynolds was too busy. That's when I blew up. But, dammit man, it doesn't make the facts any less easy to face now . . ."

Norris cleared his throat. His face was stern.

"You—you could go one . . . to . . . Calleo, yet . . ."

For a moment his meaning didn't reach the other. Then Hamish stood up.

"That voice . . . the radiophone . . . they're trailing me in the *Clytie* . . . the Consolidated yacht. I don't dare . . ."

"You mean . . . ?"

"She's an ex-sub chaser. She carries a torpedo tube . . ."

Norris' face hardened.

"You don't mean . . . they'd try that?"

Hamish nodded.

"That's what they said. They'd do

Continued on page 56





De Forest  
D-7  
Reflex  
Radiophone

## Listen to Half the Continent This Christmas!

HERE'S the latest De Forest triumph, the D-7 Reflex Radiophone\* Receiver. It's the newest and most sensitive set of them all, with a thousand mile range on a two-foot indoor aerial! That's what you've been waiting for. No outside aerial is needed. The whole set is as you see it here.

Easy to control with its single knob—small, compact, super-efficient—and an ornament to any library table!

Economical to operate, too, because you get five stages of amplification on three tubes, and correspondingly longer life for your storage batteries.

If you want to bring into your home the news, the music, the lectures of half the American Continent—with no trouble—clearly, without interfering noises—this is the set for you. Remember it's a Radio Christmas—and here's one set that is all you ever hoped a receiver could be. Ask your De Forest dealer about D-7 and the other De Forest sets—today.

De Forest Radio Tel. & Tel. Co.  
Jersey City, N. J.



\*Reg. U.S. Pat. Off.

## What is the Finest Receiving Set Made?

To be worthy of this distinction, the set must have three characteristics—

- World-wide receiving range—
- Reception in all wave lengths—
- Reception without distortion.

RadioCraft D-6 Regenerative Radiophone\* (by permission of De Forest Radio Tel. & Tel. Co.) will receive even European stations, and of course all those on this continent.

It receives on all amateur, broadcasting, and transatlantic wave lengths.

In clearness and avoidance of distortion, it must be heard to be adequately described.

D-6 uses outside aerial only, and head sets or loud speaker.

It claims to be the finest receiving set now manufactured and any authorized De Forest dealer (who also carries the RadioCraft line) will be glad to prove this to you by actual demonstration.

RadioCraft Regenerative Radiophones\* (by permission of De Forest Radio Tel. & Tel. Co.)

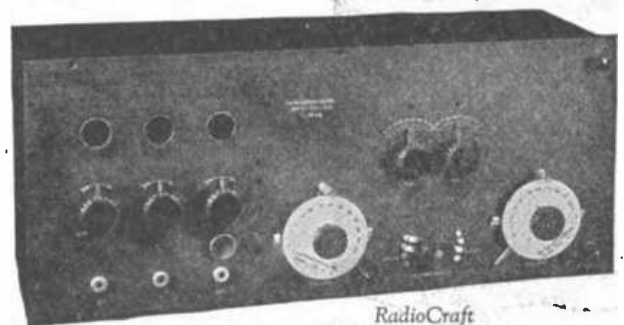

RadioCraft  
Regenerative Receiver  
Type D-6

range from the simplest to the most elaborate.

It is unnecessary to add that this entire line of De Luxe radio equipment is most exquisitely finished in every detail.

The RadioCraft Co., Inc.  
139 Franklin St., Jersey City, N. J.



\*Reg. U.S. Pat. Off.

Tell them that you saw it in RADIO

Trade  Mark

# The Set that Grows



Front View  
Panel No. 2



Rear View With  
Cover Removed  
Panel No. 9

HERE is the nucleus of your future set.

A 150-300 meter audio detector equipped with potentiometer.

Add other panels for loud speaking, greater distance and more select tuning.

Our Bulletin No. 302 describes these novel sets with their outstanding features. Write for it!

**THE E-D MANUFACTURING CO.**  
PHILADELPHIA, PA.

**"LISTEN IN WITH ED."**

## BRYANT TRANSFORMERS

FOR AUDIO FREQUENCY

IMMEDIATE DELIVERY

A better transformer for music and speech is not made. We leave the appearance to you.

Designed by former Government Expert RADIO AID

Designed to amplify all audio frequencies in voice range with equal intensity. Takes up less panel space, is extremely rugged, has beautifully blued steel mounting frames, insulation resistances all above 10 megohms.

Both windings of heavy wire—will not burn out.

*Positively Guaranteed as Represented*

Ratio 3½ to 1 **\$5.00**

*Excellent Proposition to Dealers*

### BRYANT RADIO COMPANY

PALO ALTO, CALIF.



Constant, steady voltage.  
No battery noise in your V. T.  
Easily recharged at home.  
A life of from 3 to 5 years.  
Jolly electrolyte, no spillage.  
Oily on for any required voltage.

—A FEW OF THE REASONS WHY

### SNELL CELLS

#### STORAGE "B" BATTERY

should be on YOUR set.  
At your Radio Dealer, or

22 v., 11 cells.....	\$ 6.50
44 v., 22 cells.....	12.00
Chemical Rectifier.....	1.25

F O B San Francisco

Order yours now for immediate shipment.

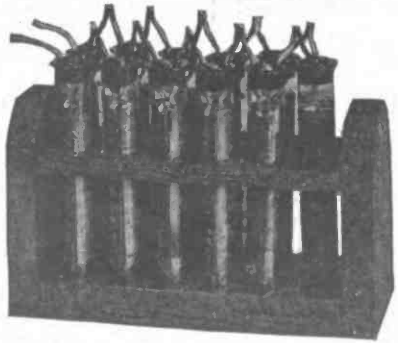

**MANN & SNELL 6BQL 4733 Geary St., San Francisco, Ca.**

Tell them that you saw it in RADIO

*Continued from page 54*

anything . . . . for oil. They're a bad gang, Bob . . . ."

"But if you ran for it . . ." Norris persisted.

Hamish swung on him savagely.

"It's not that I'm afraid—not for myself," he shot out.

"What then?"

"It's . . . . it's her, Bob. It would kill her, if anything happened . . . ."

The operator studied him through half-closed lids.

"Know what the date is?" he asked quietly.

The captain stared, puzzled. Then his eye sought the calendar.

"The twenty-fourth?"

"Christmas Eve!"

"God . . . !"

"Hamish . . ." He dropped the title.

"Wouldn't . . . she rather have you dead . . . than live with that two thousand?"

It was brutal. He meant it to be.

The Captain groaned.

"Don't Bob," he begged. He fumbled for a justification. It's her life on the one side, against . . . ."

"Against phantoms . . . . your honor . . . . facts . . . which would she rather have?"

Acute agony shot through the other. His hands, where he gripped the table, whitened. For an instant he stood backed against the door . . . . The sound of his feet running along the deck, came to Norris sitting alone beside the operating table.

Below, the ship's telegraph jangled suddenly, and the *Susan Reynolds* wallowed over on her beam ends . . .

Norris picked up his receivers.

" . . . Hamish to the fone . . . *Susan Reynolds*, are you there . ?"

Smiling, Norris turned out his detector lamp and lighted a cigarette.

Christmas Eve!

Grey dawn, with the rocking swells astern off the northeast . . .

Captain Hamish staggered in, white, drawn . . . He seemed older.

"We lost only six hours . . . . off the schedule."

Norris forced him down in a chair and poured out a drink.

"Throw it down," he said. "You need it . . . . I'm glad."

Hamish picked up the drink. Norris turned to his drawer and scribbled on a bit of paper with a fountain pen. Then he turned and held out . . . a check.

"It's worth two thousand," he said, "to meet a man . . . ."

Captain Hamish stared at him with stricken face, breathing heavily . . .

"In God's name . . . who . . . ?"

But Norris held up his hand.

"I'm Reynolds," he said. "Robert Norris Reynolds . . . ."

He went out and closed the door. It is not pleasant to see one of your commanders crying over a bit of paper . . .



# The Future of RADIO

The fun and entertainment that you and your friends get from Radio should never be marred by failure of your apparatus to properly do its part—and it won't fail if it is properly made.

The Radio "fans" of today will be the Radio experts of the future—*provided* the equipment used *now* gives service and satisfaction. If you are interested—much or little—in Radio, don't let inefficient equipment discourage you. Insist on SIGNAL parts and SIGNAL sets.

Every SIGNAL item is made in a factory that has grown up with "wireless." One of the earliest manufacturers of such equipment, SIGNAL offers you, now, Radio parts and Radio Sets that are *right*, and are *dependable*. To insure getting all there is—to be confident that nothing goes by you without your consent—say SIGNAL, and stick to it, when you buy equipment of any kind.

**SIGNAL** Electric Mfg. Co.

Factory and General Office

1913 Broadway, Menominee, Mich.

Atlanta, Boston, Cleveland, Chicago, Minneapolis, Montreal, New York, Pittsburg, St. Louis, San Francisco, Toronto

(1922)

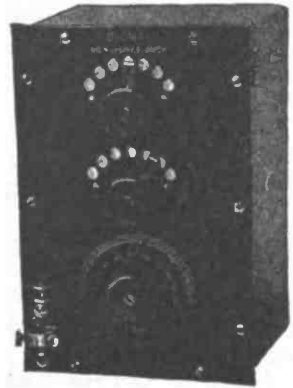

## Signal Junior Detector Units

For the amateur, and also the rapidly growing commercial field, we have developed an entirely new line of apparatus, in which is incorporated the very latest advancement of the science of Radio.

Each individual unit is primarily a separate and distinct device, complete in itself, yet by adding one to another any combination may be obtained, from the simple crystal detector through all the stages of radio-frequency and audio-frequency amplification.

Seasoned knowledge and experienced handicraft are built into these units—the product of a plant and an organization whose history in Radio dates back to the earliest days of "wireless."

*You'll find our local address in your Telephone Directory.*

### COUPON FOR GUIDE TO RADIO SATISFACTION

Please send, without obligation, your interesting book about SIGNAL parts and sets, to the name and address written in the margin of this page.



Patented  
Aug. 1, 1922

"The Peak  
of  
Perfection"

## -matches your other dials

Don't spoil the appearance of your set with dials that don't match up. The dials on most rheostats won't match the other dials on your panel—the rotation is too great. The dial on the **PARKIN Rheostat** (Patented) will match the other dials on your panel—the scale is the same (100 divisions), the rotation is the same (180°). And this is but one of its many superior features. The resistance element is mounted in a recessed groove in the back of the dial *outside the cabinet*, which gives a host of important advantages found in absolutely no other rheostat. Read the complete description in the new **PARKIN Guide and Catalog**. Send the coupon below to us, with your own name and your dealer's name, and secure a copy absolutely free.

*This will be a RADIO CHRISTMAS.*

**Parkin Manufacturing Co.**  
San Rafael,  
California

*The handsome new illustrated Guide and Catalog to PARKIN "Peak of Perfection" parts and supplies is now ready. Just in time for you to use in picking "Peak of Perfection" parts for CHRISTMAS. Dials, rheostats, knobs, condensers, sockets, switches, levers, etc.—the best that money can buy, every one the "Peak of Perfection", yet the price is no higher. Quality dealers sell them.*

*Send us your name and your dealer's name in the coupon below, and we will mail you a copy of the new PARKIN Guide and Catalog, the little wonder book of radio, absolutely free. This will be a RADIO CHRISTMAS.*

**Mail this  
coupon  
NOW!**

**PARKIN MFG. CO.—SAN RAFAEL—CALIFORNIA.** Gentlemen:—  
Please rush me a copy of the new Guide and Catalog to **PARKIN Peak of Perfection PARTS** so I will get it in time to use for Christmas. My own name and address, and the name and address of the radio dealer where I do most of my buying, are as follows—

Name..... Dealer.....  
Address..... Address.....

### INDUCTANCE DESIGN

*Continued from page 26*

$F'$  from the curve. Knowing this, it is a simple matter to calculate the inductance of your coil from either equation (1) or (2).

The accuracy of this universal formula for all closely wound coils has been compared with the various precision formulas such as Stefan's, Kirchoff's and others, and the variation found to be very small, less than 3% in most cases, and in many cases the deviation was 1%. It is therefore evident that for all practical engineering purposes the Brook's formula is satisfactory. This accuracy holds even the extreme case of the inductance of a single turn.

The shape factors  $F'$   $F''$  have a physical significance. A given length of wire has a definite constant resistance (at normal temperature) regardless of how it is wound. However, it has a different inductance for each different shape into which it may be wound. There is one shape which will yield the maximum inductance for the given length of wire. This shape will naturally be the most efficient design for this inductance, since the  $L/R$  ratio is a maximum. Every other shape of coil will yield an inductance less than this maximum, but a definite percentage of the maximum depending upon the shape. The first part of the Brook's universal formula, namely

$$\frac{Cm^2}{b+c+R}$$

gives the maximum inductance obtainable with a given length of wire when wound in the most efficient shape. The second part of the formula, namely the shape factors  $F'$   $F''$ , represent the deviation from this maximum due to winding in other than the most efficient shape. The shape factor then gives the percentage of the maximum inductance obtainable with a given length of wire when wound in any shape other than the most efficient.

Numerous curves have been prepared giving for different lengths of different sizes of wire the maximum inductance which can be secured with these lengths when wound in the best shape. One such curve is given in Fig. 4. By the use of these curves and the shape factor chart of Fig. 2 and 3 the inductance of any closely wound coil may be easily obtained with hardly any calculation. Thus by knowing the number of turns and diameter of coil we know the length of wire used. From Fig. 4 or a corresponding figure we find the maximum inductance which can be obtained with this length and size of wire. From the coil dimensions  $a$ ,  $b$  and  $c$  we obtain from the shape factor charts, Fig. 2 and 3, the shape factor of the coil, which, when multiplied by the maximum inductance, gives the actual inductance of the coil.

Tell them that you saw it in RADIO



# Make the most of Your Christmas Trade

*Sell Crosley Radio Instruments*

CROSLY Instruments and Parts will be your best sellers during the Christmas Season. They are what the consumer wants. A moderate priced instrument with all the good qualities of the more expensive sets.

The demand for CROSLY Instruments has been increasing by leaps and bounds. The reason is simple. All of our larger units incorporate one stage of Tuned Radio Frequency Amplification. We were the first to bring this feature on the market and we have developed it to its highest degree. This simplifies tuning, increases the range and clarity and eliminates interference. Crosley instruments are popular wherever they are tried.

Advertisements such as this and others of a similar nature will appear in all the leading Electrical and Radio Publications during December and the succeeding months. Combined with our previous national advertising, our continued publicity will create a demand for CROSLY APPARATUS such as you have never experienced before.

You cannot afford to be without a supply of CROSLY Instruments during the Christmas Season.



Write for fully descriptive catalog and discount sheet.

**CROSLY**  
BETTER-COST LESS  
RADIO

**CROSLY MANUFACTURING CO.**

Department H-4  
Cincinnati, Ohio

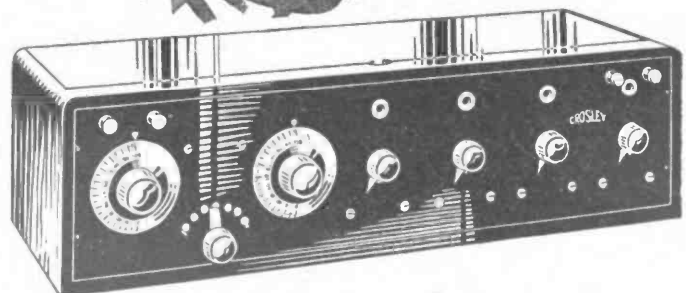

CROSLY RECEIVER MODEL X. A four tube outfit the same as shown in the above scene. It consists of tuner, one stage of Tuned Radio Frequency Amplification (the feature that has made our larger sets so popular), Detector and Two Stages of Audio Frequency Amplification, in a beautiful mahogany finished cabinet. It will bring in distant stations loud and clear. Price without phones, batteries or tubes .....\$55.00

Tell them that you saw it in RADIO

## Listen to the World with Tresco Tuners

Regenerative Type Tresco  
Super-Universal Tuner

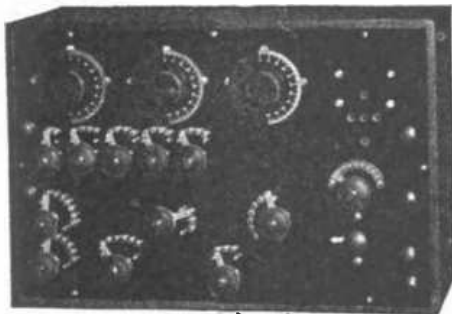

DE LUXE TYPE

need replacing except the high voltage batteries, a replacement of which costs only a few dollars. We ship only by express. You do not need to know anything about wireless to operate this tuner or to get the signals and telephone reports. Cabinet is highly polished and all parts nickel finish. If you wish extra loud signals you may use one or two step amplifier, as posts are provided on the tuner for this purpose. We only sell this tuner assembled and calibrated to your bulb ordered with the set. It is complete with all that is needed except a pair of phones and a few dry cells to light the filament of the Audion. Ready to use when it arrives with full directions, so that a child can operate it. Priced at \$125.00, F. O. B. Factory. Bulb, \$5.00.

Licensed under Armstrong Patent No. 1113149.

CIRCULAR FREE

**TRESCO, DAVENPORT, IOWA**  
BOX 148

## PROFESSIONAL RADIO OPERATOR

Continued from page 14

are conducted, to give the applicant a searching oral examination; he was likely to be escorted into the radio shop and asked to pick out a compound-wound generator from among a flock of shunt-wound machines, or perhaps would find himself introduced to a "jimmied up" quenched-spark transmitter, with a request by the examining officer to "make it work."

Before being given the technical examination, the candidate must successfully pass the Continental code tests, first receiving and then sending. The receiving test for the license here considered consists of one hundred words sent on an automatic transmitter at a speed of twenty words a minute, the signals being received in a pair of ordinary telephone receivers shunted across a high-frequency buzzer and provided with an audibility coil whereby the strength of the signals may be varied at will. The applicant must copy not less than twenty consecutive words without a break or an error; and since one hundred words are transmitted in the test, he has virtually five chances to do this. The candidate usually is not allowed to make corrections in his copy after the transmission of the test words.

The transmitting test is similar to the receiving in that one hundred consecutive characters, that is, twenty words, must be sent without a break from a text totalling five hundred letters and figures (five letters are counted as one word). The sending is required on an ordinary small Morse key, which the applicant may adjust to suit himself; and the signals are produced not only audibly on a buzzer, but also visually on a strip of paper tape in an electrical recorder, which leaves the candidate no opportunity to deny his errors. Many who pass the receiving tests fail in the transmitting.

As a result of exaggerated stories circulated by unsuccessful applicants for commercial operators' licenses, there seems to have come to be a wide-spread belief among the amateurs that the radio inspector's automatic transmitter used in giving the receiving tests is a villainous sort of contraption which sends a terrific scramble of tangled text in a rattling, snapping style that only a code wizard can hope to read.

While the automatic transmitter may have sounded like this to some unsuccessful candidates for licenses, it was most likely owing to their huge agitation at the radio inspector's test-table, rather than to anything wrong with the sending machine.

The youthful adventurer hailing from the country, especially he who is bur-

Continued on page 62

# BRACH

## VACUUM RADIO PROTECTOR

Here is an instrument that is indispensable whenever and wherever you have to contend with static interference with radio signals and voice currents. Experienced engineers, knowing well the past performances of the Brach Arrester, specify and recommend it. Radio amateurs can depend upon it absolutely.



Indoor Type

Also Makers of Solderall — Best  
For Soldering Radio Connections.

Statements, unsupported by facts, have appeared in competitive advertising that vacuum arresters lose their vacuum. Many years' experience by the largest electrical firms in the use of the Brach Vacuum Arresters disprove this allegation.

It is Listed by the  
Underwriters'  
Laboratories



Outdoor Type

**L. S. BRACH MFG. CO., NEWARK, N. J.**

Coast Representatives: Pacific States Electric Co., San Francisco,  
Los Angeles, Oakland, Seattle, Portland, Spokane.

## The Riggs Rectifier

FOR CHARGING STORAGE BATTERIES

110 volt, A. C. 60 cycle.  
6 volt, 5 amp. D. C.

**\$12.50**

prepaid anywhere.

**W. H. RIGGS**

Box 304, Everett, Wash.

**THE RIGGS MFG. CO.**

URBANA, OHIO

Discount to Dealers

## TRACO Loud Speaker

**Price \$40**

Complete F. O. B. San Francisco

Vernier Controls \$1.00

THE  
**Radio Appliance Co.**  
INC.

1352 Divisadero Street, San Francisco

Tell them that you saw it in RADIO

# RHAMSTINE★ PRODUCTS



Detecting and Amplifying Cabinet \$50

Famed for their performance and reliability, Rhamstine\* Products bring to the radio public, at a moderate cost, apparatus of the highest standard.

It is essential that you use correct and efficient units in your radio construction to secure the best results; and in specifying Rhamstine\* Products you are assured of satisfaction. They have no superior in their field.

On request we will send you a booklet showing the complete line together with prices.

*Manufactured by*

## J. THOS. RHAMSTINE\*

2152 E. Larned St. Detroit, Mich.

*\*Maker of Radio Products*

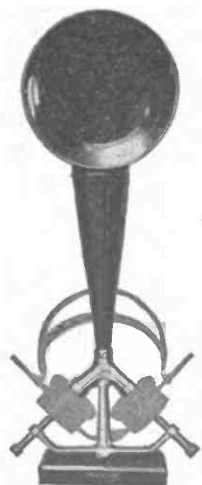

Adapt - O - Phone  
Without Receivers  
\$12.00



Radio Frequency Ampli-  
fying Transformer  
\$4.50



Audio Frequency Ampli-  
fying Transformer  
\$4.00

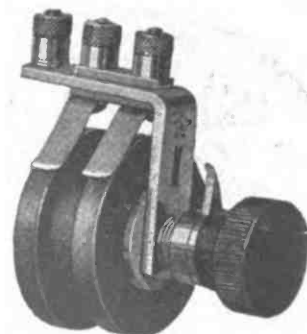

Potentiometer—  
Type A—500 Ohms  
\$1.75

Tell them that you saw it in RADIO

## The Living Room is no Place for a Storage Battery

Locate it in a permanent place away from fine furniture and rugs, then use a

### LEICH NON TUNE RADIO RECTIFIER

to keep it in condition. No attention—just throw the switches. Safe—Convenient—Dependable.

Your tubes will work more consistently with the steady voltage delivered by a fully charged battery, and your evening entertainments will not be subjected to the annoyance of continual adjustment of tube filaments. Your battery will have a longer life under these conditions.

The Non Tune Radio Rectifier needs no attention while charging. During power interruptions storage battery circuit is automatically opened. The Non Tune Rectifier is a time-tested instrument that is used extensively for railway signal and other work which requires an efficient and dependable machine.

Ask your dealer—or write for Bulletin No. 100.

## LEICH ELECTRIC CO.

Manufacturers  
Telephones, Switchboards, Accessories  
GENOA, ILLINOIS



## DAYTON RADIO PRODUCTS

Are the most complete and most accurate of any Radio apparatus made by one Company in America.

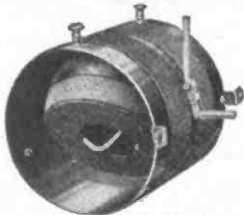

Type B Vario Coupler



Dayton Phone Receiving Set

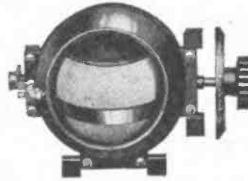

Moulded Bakelite Variometer

### VARIABLE CONDENSERS IN 4 SIZES

	List Price
Type 9 P. C. S. Square and Round Plate .0003 Mf.	\$3.00
Type 17 P. C. S. " " " " .0005 Mf.	3.60
Type 31 P. C. S. " " " " .001 Mf.	4.50
Type 45 P. C. S. " " " " .0015 Mf.	5.30
Type 17 P. C. S. Condensers with Vernier attached.	4.40
Type 31 P. C. S. " " " " " " " "	5.30
Type A Variometer Moulded Bakelite.	6.75
Type A Vario-Coupler Moulded Bakelite.	7.00
Type B Variometer Bakelite Tube Type.	4.25
Type B Vario-Coupler " " " " " " " "	4.75
Type C Vario-Coupler " " " " " " " "	3.75
Rheostats.	1.10
Panel Switches, 8 Points.	.90
Phone Jacks.	.65
Genuine Bakelite Knobs and Dials 3 Inch.	.75
Insulating Rubber Tubing, 10 ft. package.	.45
Radio Phone Receiving Sets.	75.00

Jobbers and Manufacturers write for Catalog and Discounts

## The A-C Electrical Mfg. Co. Dayton, Ohio

Makers of Electrical Devices for over 20 years



### JEWELL LIGHTNING ARRESTER

Approved by Underwriters' Laboratories, latest Code. Carbon block types (not vacuum type) using a brown glazed porcelain case which can be installed inside or outdoors. Carbon block arresters have been standard in Railway signal and telephone protection for over 20 years. Ask your dealer or write us for special circular.

PRICE \$1.10

JEWELL ELECTRICAL INSTRUMENT CO.  
1650 WALNUT ST. CHICAGO

Tell them that you saw it in RADIO

Continued from page 60

dened with a gnawing, guilty apprehension about that big sending outfit he has been operating on unlawful waves and without a license, or who has some other equally grewsome radio-crime skeleton rattling its bones in his closet, is predisposed to become overwhelmed with secret terror in the laws-and-government chill of the radio inspector's office, and to feel about as much at ease there as if he had been thrown into a cave full of tigers and crocodiles; and when his mental state is such as this, small wonder it is if the signals of the inspector's sending machine sound in his ears like a demoniacal laugh of the King of Hades doing a fox-trot on the coals in gleeful expectation of a newcomer to his unholy domain.

The sending of the automatic transmitter, as a matter of fact, is accurate and precise, and not at all difficult to read. The transmitted text is not straight reading matter, for this would be no test, but consists of short phrases freely interspersed with numbers and punctuation marks, — something like this:

Steamer off Cape King, girl to Baltimore: 17896 snowing north. S-O-S; fire destroyed cargo 92 abeam White Bluffs? K-O-D-Q, K-O-D-Q, K-O-D-Q de W-D-G. Gear damaged wheel,—and so forth.

The punctuation marks do not have to be written down, but the omission of anything else is counted as a break or an error. The transmitter occasionally slurs a letter when the contacting device is being shifted up or down the dials; but the applicant should not become confused or dismayed at this, because the radio inspector listens to the sending also, and does not count any break made by the machine against the candidate.

In the case of failure to pass the examination, the applicant can not reappear for another attempt until after the expiration of three months. Several cases have been known of candidates who, while unsuccessful before one radio inspector, took the examination again in a different radio district before three months had passed. Since an individual record of every applicant for a radio operator's license, whether he is successful or not, is kept at Washington, any such prohibited practice is almost immediately detected. The illegally obtained license is then revoked; and the holder of it not only is barred from re-examination for a year or more, but is liable to prosecution.

I happen to be acquainted with one ingenious amateur who, having heard many alarming stories about the radio inspector's demon sending machine and not being able financially to weather a three-months setback in case of failure

Continued on page 64



# REMEMBER THE NAME!

An Old  
Organization  
A New Name  
and a  
Real Radio Service

-o-

The Largest  
and Most Complete Stock  
in the West  
Sold By Men Who Know

-o-

The List Speaks  
For Itself

-o-

**Order Now!**

RADIO CORPORATION OF  
AMERICA

REMLER RADIO MFG. CO.

A. H. GREBE & CO.

COLIN B. KENNEDY CO.

GENERAL RADIO CO.

ACME APPARATUS CO.

DUBILIER CONDENSER CO.

KELLOG SWITCHBOARD &  
SUPPLY CO.

ADAMS MORGAN

CUNNINGHAM TUBES

NATHANIEL BALDWIN, INC.

FEDERAL TEL. & TEL. CO.

WESTERN ELECTRIC

RADIO INSTRUMENT CO.

HERBERT FROST

-o-

**Immediate Deliveries!**

MAIL ORDER  
DIVISION

OBSERVE  
THE SIGN



OBSERVE  
THE SIGN



820 W. 7th St.  
Los Angeles

*Oliver Garretson*  
Manager



560 E. Colorado  
Pasadena

*E. G. Arnold*  
Manager

Tell them that you saw it in RADIO

# IT'S HERE!

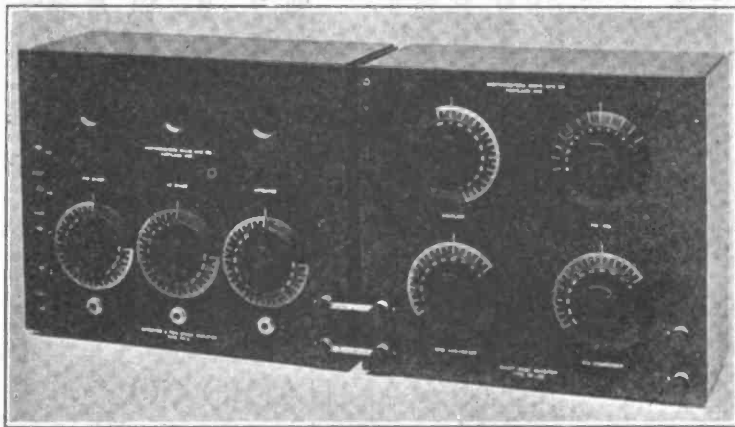

**THE NON-REGENERATIVE RECEIVER DE LUXE**  
**FOR BROADCASTING RECEPTION—NEAR OR FAR**  
**Hallock & Watson Radio Service**  
 192 Park Street "KGG" Portland, Ore.

## BRECO RADIO APPARATUS

BRING BEST RESULTS

*They are dependable*

Listed below are a few BRECO specialties:

Variometers .....	\$ 7.50	A. F. Transformers .....	\$ 5.00
Variocouplers .....	5.75	Binding Posts, N. P. or Insulated Knob .....	.10
Variable Condensers, 43 Plate .....	5.00	Mahogany Cabinets, various sizes ..	\$5 up
Variable Condensers, 28 Plate .....	4.00	Bakelite, Sheets and Panels, lb. ....	2.00
Dials, 3-in. Moulded .....	.75	Straight Circuit Tuner .....	60.00
Rheostats .....	.75	Detector and Two Stage Amplifier ..	65.00
Crystal Detectors .....	2.00	Straight Circuit Tuner, detector and three stage amplifier .....	180.00
Inductance Switches .....	.40		
Switch Points .....	.08		

Write for catalogue

**Bronx Radio Equipment Company.**  
 687 Courtlandt Avenue Bronx, N. Y. C.  
*"Manufacturers of Quality"*

## VARIABLE CONDENSERS

*Best by Every Test*

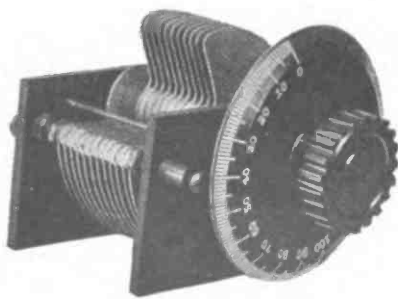

We can safely say that these condensers are the best on the market at the price.

**DESCRIPTION:**

The end plates are cut from sheet Bakelite. The movable and stationary plates are punched out of 20 gauge sheet aluminum. Contact on rotor is made with braided pigtail wire insuring perfect contact at all times. The rotor is mounted on 1/4 in. brass shaft. All brass parts are nickel plated.

**PRICES WITHOUT DIAL:**

No. 3 Plate .....	\$2.00	No. 23 Plate .....	3.25
No. 7 Plate .....	2.25	No. 31 Plate .....	3.75
No. 11 Plate .....	2.50	No. 43 Plate .....	4.50
No. 13 Plate .....	2.75	No. 63 Plate .....	6.50

Vernier attached to No. 23 and 43 are \$3.00 extra including 3 in. dial and knob. Every condenser is fully guaranteed.

### MORTON & BORK'S RADIO CO.

653 Fair Oaks Ave. Mail Orders Promptly Filled Stockton, California

*Continued from page 63*

to pass the examination, elaborately disguised himself with creole-hued theatrical pigment and a pair of blue glasses, and then went to the radio inspector's office to investigate the receiving test under a fictitious cognomen. The brown paint on his hands stuck to the license application blanks, and the affair ended rather disastrously, the adventurous amateur narrowly escaping a few months operating on a rock-pile in a striped uniform instead of at the key of a shipboard wireless set. I should not advise anybody to try the experiment.

## CODE DIFFICULTIES

*Continued from page 14*

when mentally weary, as results are always disappointing.

(8) Don't give up and don't stop your practise! The writer does not know of a single case where these little helps here outlined did not help to some extent. They are not a universal panacea, but are intended as suggestions for some of you fellows who say "Yes, I'd like radio if I only could learn the code."

## CALLS HEARD

*Continued from page 44*

By 6AMK, Los Gatos, Calif.

Spk: (5dx), (6cc), (6dd), (6fh), (6gt), (6ic), 6ia, (6iv), (6km), 6ku, (6od), (6ol), (6qk), (6to), (6to), (6up), 6wi, 6zi, (6aak), (6abw), (6acr), (6adl), 6ahq, (6ajh), (6ajr), (6akl), (6ala), (6ald), 6ans, (6aoh), (6ark), (6ara), (6avb), (6avh), (6avr), (6bps), 7fr, (7ge), (7my), 7ne, (7nw), (7oj), (7ot), 7uc, (7it), (7itw), 7ve, 7vf, 7vo, (7wg), 7zg, 7zu, (7aea), Can.—(9bd).

C. W. 4bv, 4eh, 5dd, 5hr, 5ia, 5px, 5sa, 5zh, (6cc), (6cu), 6en, (6fh), 6gd, (6ka), (6pi), 6sa, 6zf, 6zh, (6aat), 6agp, 6ahq, 6ajh, 6apw, 6arb, 6atq, 6avd, 6xad, 6bps, 6bum, 6bk, 7iz, (7ir), 7lu, (7mf), 7sy, 7tn, 7to, (7iq), 7wm, 7zb, 7zk, 7adl, 7aea, 7aem, 7afw, 7ahw, 8cm1, 9kk, 9pn, 9aim, 9amb, 9anf, 9aos, 9avs, 9awm, 9bbf, 9bji, 9bas, 9cni, 9dtm, 9xaq.

By 6BPL, 212 Fulton St., Palo Alto, Calif.  
 C. W.: 5za, 5px, 7bf, 7ay, 7pm, 7ac, 7ak, 7bk, 8yd, 8yp, 9xai, 9gk.  
 I. C. W.: kfay, 5xd, 5yq.  
 Phone: chbc (Can.), whb, wos, kxss, kme, kyt, ksd, 6xb, 6auu, 7zi.  
 Spk: 5dx, 7fq, 7gi, 7ve, 9bd (Can.).

By 6BJC, 540 St. Andrews Pl., Los Angeles, Cal.  
 All C. W.: 4bv (Can.), 4eh, 5px, 5xd, 5sa, 5zap, 5zh, (6ak), 6cc, 6cj, (6gr), 6gy, 6ka, (6lo), 6rd, 6uw, (6aat), (6aah), (6ajh), (6ajf), (6atq), (6abz), (6bcd), (6bcj), -vcr, (6bjy), 6bz, 6bql, (6bum), 7bj, 7ac, 7it, 7lu, (7mf), 7aea (qra!), 7afw (qra!), 7ahw, 7zb, 7so, 8asv, 9am, 9pi, 9amb, 9awt, 9awm, 9aul, 9bji, 9bju, 9bey, 9cm1, 9cmk, 9dle, 9dtm, 9xaq, 9zaf.  
 Anyone hearing 6B.J.C's C. W. pae QSL by card.

By 6AUB, 3369 28th St., San Diego, Calif.  
 C. W.: Can.—4bv, 5nk, 5xd, 5za, (c. w. & voice), 6ak, 6av, 6cc, 6cj, 6cn, 6cp, 6cu, 6ea, 6eb, 6ec, 6en, 6eo, 6gf, 6gr, 6gz, 6ka, 6lo, 6iv, 6nx, 6pi, 6rd, 6rk, 6sa, 6ic, 6ii, 6uw, 6vf, 6aag, 6at, 6abz, 6ahp, 6ahq, 6ajf, 6alu, 6amn, 6aol, 6apw, 6aqw, 6arf, 6asj, 6atq, 6atq, 6auu, 6avd, 6avn, 6avr, 6awt, 6bbc, 6bdd, 6bcj, 6bcr, 6bdw, 6bec, 6bes, 6bfp, 6bic, 6bjc, 6bji, 6bjj, 6bjr, 6bjx, 6bkb, 6bki, 6bko, 6bmd, 6bmz, 6bod, 6boo, 6bps, 6bq, 6bq, 6bq, 6bq, 6bq, 6brg, 6brk, 6bsa, 6btb, 6bum, 6lun, 6bvq, 6bwp, 6xr, 6xad, 6xas, 6xav, 6zi, 6zi, 6sx, 6zo, 7bb, 7bj, 7bk, 7lu, 7ny, 7ot, 7iq, 7aem, 7so, 7su, 8bdv, 9amb, 9bey, 9bji, 9cfy, 9zaf.  
 Spk: 6ex, 6ic, 6lu, 6mh, 6ol, 6qr, 6qy, 6tu, 6up, 6vx, 6ak, 6abw, 6acr, 6ahu, 6alc, 6ald, 6alv, 6ark, 6atf, 6avr, 6awh, 6bal, 6bcn, 6bic, 6bvd.

Anyone hearing 6AUB 5 watt ACCW Pse QSL.

*Continued on page 96*

Read the *RADIOADS* on Page 111

Tell them that you saw it in RADIO

*Surprise Yourself at*

# Xmas

*with a* **MILLER  
UNIVERSAL  
WAVE  
RADIO  
FREQUENCY  
AMPLIFIER**



*Best for reception at Christmas or any other time of the year*

**This remarkable transformer will enable you to receive over almost unbelievable distances**

**T**HE addition of 2 or more stages of Miller Radio Frequency to your present set will add much pleasure to your winter night reception, and is not expensive. Results are assured—this system of Radio Frequency is the invention of Dr. John M. Miller of the Naval Radio Research Laboratory, Bureau of Standards, Washington, D. C., and is unquestionably superior to anything heretofore marketed. Your Dealer has this line—or should have; do not accept any substitute, but demand the Miller—the BEST. Write us direct if you wish, giving name of your radio dealer. We will serve you promptly.



*Just a Christmas Suggestion to  
Mr. Manufacturer*

Have you anything which can be moulded from genuine Bakelite to advantage? Let us estimate for you. Bakelite Moulding is our business, and a trial will convince you.

**COAST RADIO CO., Inc.**  
El Monte, California

*Owners and Operators of K U Y*

Tell them that you saw it in RADIO



No. 2500  
2000 Ohms  
**\$6.00**

No. 2501  
3000 Ohms  
**\$7.00**

## Concealed Cord Tips

**T**HIS is an important feature of the Manhattan Headset. Concealed Cord Tips have two real advantages:

The first is the elimination of all possibility of unbalancing the receiving set and decreasing the strength of the headset signals by having the hand come in contact with exposed cord tips or terminals. The loss of strength due to this contact is often as great as 50 per cent.

Manhattan Headsets have concealed cord tips.

By enclosing the cord tips, all obstructions on the outside of the receiver are removed and the smooth molded case will not scratch the handsomest furniture.

The Manhattan Headset case is free from obstructions.

In addition, the cords of the Manhattan Headset are designed with two other important features.

1. Strain on the terminals is relieved by a tie-cord attached to a small eyelet in the case.
2. The polarity of the cords is indicated and the terminals within the receiver case marked. This permits the headset to be correctly connected in the circuit to give the best results.

Manhattan Headsets are prized alike by professional and amateur operators. Identify them by the "M-Flash-Seal" on the back of each receiver case. Look for it when buying your Headset. It is your guarantee of Manhattan quality.

**MANHATTAN**  
ELECTRICAL SUPPLY CO., INC.

*Makers of the Famous Red Seal Dry Batteries*

New York      Chicago      St. Louis      San Francisco  
17 Park Place    114 So. Wells St.    1106 Pine St.    604 Mission St.

## SHORTER WAVELENGTHS

*Continued from page 29*

"feed-back" instantly so as to interrupt the "run-a-ways." It is like a series of "whip cracks." Bolitho was apparently the first inventor to disclose this.

These circuits amplify at much more than the inverse square of the wavelength. The law is a doubly exponential one. Hence we see the enormous values of amplification of 5 to 10 million times possible with the arrangement using waves of 20 meters or less.

The fact that longer "quenching" intervals i.e. lower frequency without apparent limit, on the other hand, *increases* the sensitiveness instead of decreasing it, indicates that a true "run-a-way" set of oscillations is produced and not mere amplification. These quenching circuits do not seem to interfere with each other even when a number are used in the same neighborhood, quite in contrast to other circuits. The above circuits may be approached by an observer without disturbance due to external capacity even when using very short waves. For users of the usual regenerative circuit this new method gives a notable improvement, as the short wave amplification is tremendously greater.

When using measuring apparatus, etc., near these quenching "whip-crack" circuits, the reaction of the former must be kept vanishingly small or the latter will be kept in continuous irregular oscillation.

Short waves have no disadvantages in the super-regenerative circuits. In ordinary circuits they can not be easily amplified or "feed-back" actions controlled. The observer's body distorts the effects sought.

The re-radiation of energy from a short wave receiver when oscillating is greater in proportion to the fourth power of the frequency. At 150 meters it sends out 16 times the energy emitted at 300 meters under the same conditions. If, however, sets are used which cannot oscillate but merely regenerate the short wave comes into its own kingdom of usefulness.

### SPECIFIC ADVANTAGES OF SHORT WAVES

A—A better design for a loop is possible. There is less stray capacitance between wires, and sharper tuning for this reason. There is a stiffer circuit possible if a very small tuning condenser is used. The last two factors partially neutralize each other, but there is a net gain if the loop is correctly designed.

B—The "following" of the voice or music wave by change of amplitude in broadcasting is accomplished more quickly than with a longer wave; since it generally takes a definite number of oscillations to change from the steady value to a larger or smaller one in order to "out-

*Continued on page 68*

Tell them that you saw it in RADIO

# You don't experiment when you deal at Wireless Headquarters

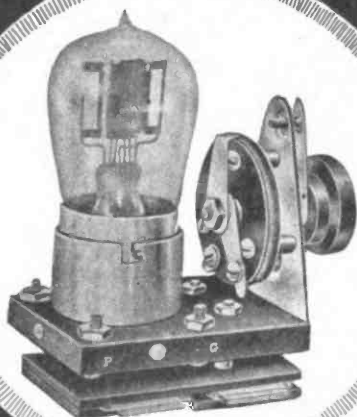

THE WIRELESS SHOP are Manufacturers of all kinds of QUALITY Radio Equipment, including Detector and Amplifier Control Units, Potentiometers, Spider Webs, Sockets and Rheostats, Binding Posts, Transmitting Condensers, Radio Jacks and hundreds of other standard and proven appliances.

All Radio equipment is manufactured by this Company under a positive guarantee of the HIGHEST QUALITY.

Thousands of Amateurs in all parts of the United States have found that Radio equipment manufactured by THE WIRELESS SHOP to be of the very highest quality. For more than ten years QUALITY has been the outstanding feature of our products. When you deal with this Company you do not experiment—all equipment manufactured in our plant has passed the severest test before it is offered to the public.

## Note this Detector Unit for \$4

We are featuring—at this time—this complete DETECTOR UNIT, designed for back of panel mounting. By using this new Unit it is a simple matter for any Amateur to build up a Receiving Set. All that is necessary is to drill 3 holes in your front panel, mount Unit and wire to Tuner. A complete Unit consists of socket for tube, rheostat, mica grid condenser and mica by-pass condenser, as well as knob and indicator.

Our special price of \$4.00 is so low that you cannot afford to assemble the separate instruments yourself.

## Write For Our Illustrated Folder on Radio Appliances

We have recently issued an interesting folder, "Radio 12," which fully describes a number of the latest and most approved Radio appliances. This folder also shows how and why you can save fully 20% by dealing direct with WIRELESS HEADQUARTERS. Invaluable to novices. If your name is not on our mailing list, fill out and mail coupon below and this interesting folder will be sent—FREE.

Quality

---First, last and always

The Wireless Shop, RADIO 12  
1262 W. 2nd St., Los Angeles, Calif.  
Gentlemen:—Without obligation to me, send me your folder "Radio 12" which fully describes the latest developments in the Radio field.

Name .....

Address .....

City..... State.....



1262 West Second St.

Los Angeles, Cal.

Tell them that you saw it in RADIO

*Continued from page 66*

line" the modulation wave. It may be possible to get along on a 30,000 meter carrier wave, but most of the fine "shading" in the orchestral color tone is lost. The average ear supplies the defect unconsciously; just as it does in using the wire phone, which transmits only 30% of the impressed voice oscillations.

C.—The greatest side tone of a voice—i.e. a note of 2000 cycles—is only .04 per cent "off tune" with 360 meters. At 6000 meters it is 4 per cent off tune and very much reduced in amplitude relatively to the carrier wave.

D.—The sharpness of the band of broadcasting frequencies allows the highest harmonics to be transmitted through filters for static or interference without distortion of the sounds in the receiving phones, when very short waves are used.

E.—Short waves radiate more efficiently and allow smaller aerials proportionately to cover a given range. They afford communication at an expenditure in plain loop transmitters of less than 1/20 watt per mile over land during the day time.

F.—The condenser microphone becomes very efficient at high frequencies or short wavelengths. Anything which permits the use of this transmitter raises the efficiency of the modulator; as it is giving the best results to date at "KDKA" and other stations.

G.—There are 10 times as many broadcasting stations possible between 20 and 30 meters as between 200 and 300 meters. This allows a margin for tuning out and for side frequencies, due to the modulation band of frequencies.

H.—The ideal loop is one-half wavelength long and short waves approach this condition. The directional selectivity of short waves is evident when we are able to mistune short waves from different directions and combine them so that a signal from East to West would register, while a signal in the contrary sense would not. Another variation is to have both register on different instruments; it being understood, of course, that all signals are sent on one wavelength.

I.—Short waves are better for use on Beverage antennae or with Major General Squier's line-radio. They allow smaller structures to be used.

J.—By using 2-meter waves with continuous oscillations and 100 times the power available to Stone, Marconi has cast a beam of radiation 98 miles. The effects in the rear of the transmitter or projector were .5 per cent of those in front of it. Reflection was secured by distributing parallel oscillators or rods—in the form of a cylinder with parabolic cross section, having the oscillator which was a split rod at the focus.

In such experiments, the smaller the apparatus the more limited the range,

*Continued on page 70*

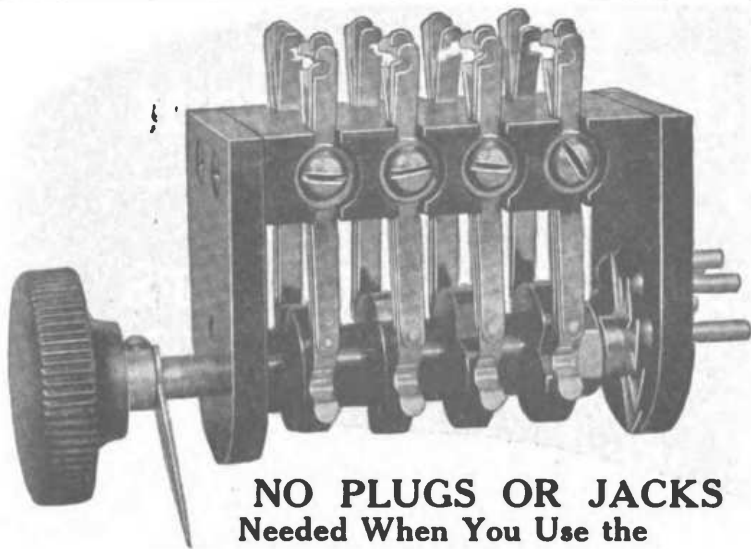

**NO PLUGS OR JACKS  
Needed When You Use the**

# ARKAY UNIVERSAL CAM SWITCH

**The ARKAY Cam Switch insures positive and instantaneous control of detector and amplifier circuits under ONE KNOB.**

Universal in operation. Provides for filament control of vacuum tubes. Valuable as a short and long wave change switch or a send-receive switch. The ARKAY Cam Switch is a beautifully built instrument, up to the high Arkay standards.

**Sold By  
Retailers  
Everywhere**

**Price \$5**

**Leading  
Jobbers  
Feature It**

**Packed One in a Box with Knob, Pointer and Mounting Screw.**

*At Your Dealers or Sent by Us Prepaid to Any Point in the U. S.*

## RILEY-KLOTZ M'F'G CO.

17 Mulberry Street, Newark, N. J.

*Also Makers of Arkay Loud-Speaker Radio Horns, Crystal Detectors, Vernier Adjusters, Phonograph Attachments, Arkay Variable Condensers.*

### WIS-WIN SWITCHES

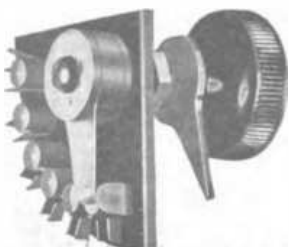

No. 756—8 point inductance switch \$1.25 postpaid. Add 5c for each additional point.

Drill only one hole in panel to mount complete switch and contacts. We make switches for all uses. Circular S-1 free on request.

*Dealers write for proposition.*

**Willis Switch & Instrument Co.**  
Kingsbury St., Jamestown, N. Y.

*We manufacture—*

**Condensers  
Variometers  
Rheostats  
Sockets  
Crystal Detectors  
and other parts.**

*Write for prices.*

**Butte Electric & Mfg. Co.**  
534 Folsom St. San Francisco, Calif.  
Phone Douglas 145

**Use the  
CLASSIFIED ADS  
If you have something  
to sell.**

Tell them that you saw it in RADIO

# A Few Good Reasons Why You Should Buy The Advance Unit Charger

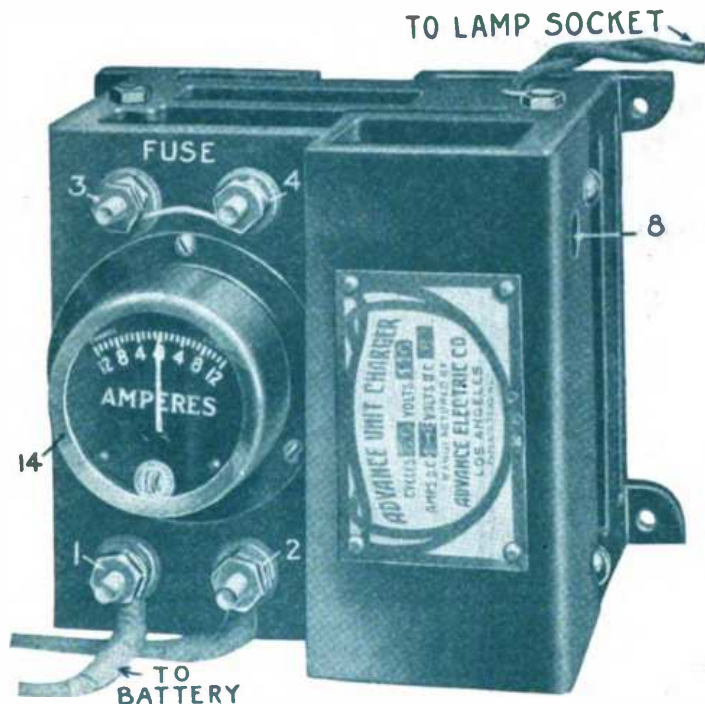

For AUTO and RADIO BATTERIES  
Charge Your Battery with an  
**ADVANCE UNIT CHARGER**  
at home for five cents

Most efficient, rigid and simple construction. Built on an entirely new idea, which insures satisfactory operation.

Will stand rough use without damage to parts. Very compact. Size five inches square. Handsome appearance.

Renewal parts after long service, fifty cents.

Self polarizing, which means that the battery may be connected to charger either way, or polarity.

Battery in ordinary condition can be charged over night.

Low price in comparison to the quality of apparatus.

The saving of much inconvenience, time and expense which will pay for the machine in a short time.

Will not injure the battery if left connected after the battery is fully charged.

Guaranteed for a period of one year.

Price, F. O. B. Los Angeles, Calif. . . . . \$18.50

## Another Advance Product--A Precision Condenser Made in Vernier and Plain That Has Met With the Approval of Those Who Demand the Finest

Beautiful in appearance. All trimmings polished nickel. Vernier shaft 1. threaded 8/32 adjustable by set screw 10 to accommodate any thickness panel or dial. Bakelite bearings 7— $\frac{1}{4}$  inch shaft both ends. Stop 9 full length of rotor. Nickeled acorn nuts 5 which insure strength. Rotor spacers 11— $\frac{5}{8}$  inch diam., machine turned. All spacers aluminum to .001 inch insuring perfect alignment of plates.

Stator spacers 12— $\frac{3}{8}$  inch diameter. Spring 13 perfect contact and friction for vernier plate. Rotor tube 2— $\frac{1}{4}$  inch diam., brass nickeled. End collar 3 Adjustable for alignment. Mounting posts 4— $\frac{1}{8}$  inch round 6/32 so spaced to accommodate any diameter dial. Brass nickeled spacers 6— $\frac{3}{8}$  inch diam. accurately machined. This condenser must be seen to be appreciated.

Vernier	Price	Plain	Price
		3 plate	\$1.90
		5 "	2.25
		9 "	2.75
11 plate	\$ 5.65	11 "	3.00
13 "	5.80	13 "	3.15
23 "	6.00	23 "	3.40
31 "	7.00	31 "	4.15
43 "	8.00	43 "	4.60
63 "	10.00	63 "	6.85

Liberal Discounts to Dealers and Jobbers.

**ADVANCE ELECTRIC CO.**

1260 West 2nd St., Los Angeles

Engineers

Manufacturers

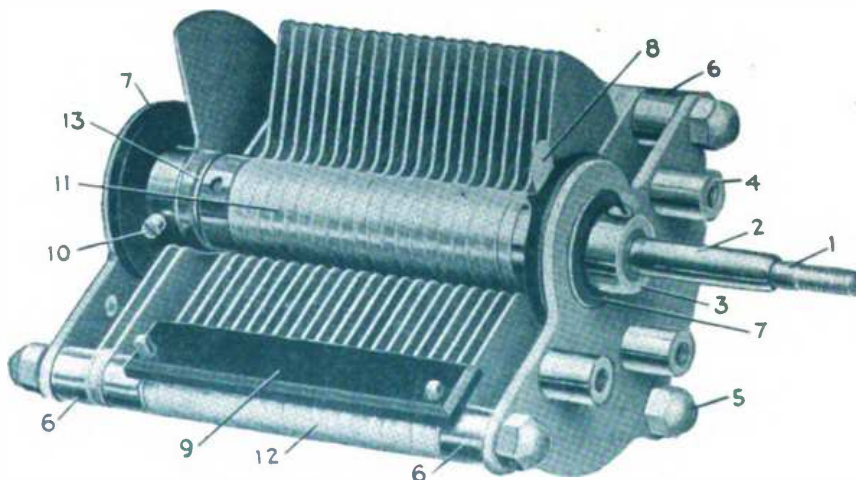

## ANNOUNCING

## The New Giblin Receiver, Detector &amp; 2 Stage Amplifier

Tuner \$15.50

Detector \$10.00

Amplifier \$24.50

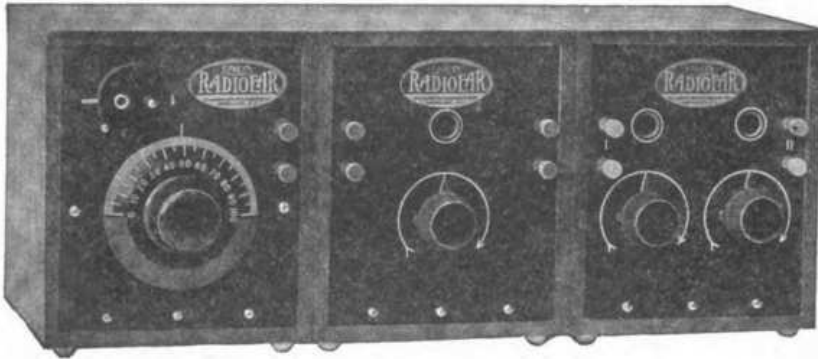
**\$50 COMPLETE  
A GENUINE PERFORMER**

incorporating

**SINGLE CONTROL TUNER**—It is easily and quickly tuned with full efficiency on any wave-length.

**DETECTOR**—Receives either local or distant stations with perfect clearness.

**AMPLIFIER**—2 stages with separate filament control securing maximum volume without distortion.

**STANDARD RADIO & ELECTRIC CO.**

Pawtucket, R. I.  
Liberal discount to dealers

Continued from page 68

although the absorption, which is greater with short waves, is counteracted by the concentration of energy flow along the "beam." "Mirrors" of 2 to 5 meters are perfectly practical and by their use multiplex working for local broadcasting may be soon developed.

In view of all the above considerations the amateur should apply, through the medium of organized experimenters' societies or radio clubs, for licenses to try out ultra-short waves. Radio schools should do so to stimulate widespread research and comparison of data. Experienced men should direct this work; as they must be able to convince the government representative in their own field.

One is sometimes asked if there is anything to "undulate" where heat, light or electric waves pass in "empty" space. It may be said that opinion is divided. Radiation is no longer deemed a continuous process, but carries "atoms" of energy according to Plank, Einstein, Evellin and others, in spite of the dilemma imposed by the fact of interference in radiations.

The general question as to the reality of "ether" or "ether waves" is of no importance to anyone. One may swallow "whole," Einstein's postulate that "empty" space has physical properties in itself; like wood, steel or water and is so changed by the presence of a gravitational field as to be able to store energy and slow down time. Again one may reject it—as some physicists have done, at least in part—and ignore the whole question of an ether. There is wave motion of "something" and that's all anyone knows about it, including "the eleven" who Einstein says have digested Relativity.

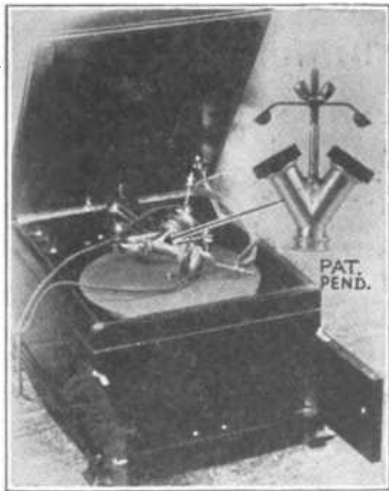
**DUPLEX VICTROLA ATTACHMENT  
New Price \$3.00**

An Attachment of highest quality for making a Radio loud speaker of your talking machine and a pair of head phones. At your dealer or post paid on receipt of price. State make of talking machine when ordering.

W. B. McMASTERS  
Wheeling, W. Va.

**FRAMINGHAM**

The Rheostat  
with the

Panel  
Bushing  
New price  
is

**75**

At  
Your  
Dealer's



Three hundred thousand Framinghams were sold last year to satisfied customers. Quantity production has reduced the cost. The saving is passed along to you in the new price of seventy-five cents.

**SHIP OWNERS  
RADIO SERVICE  
INC.**

80 Washington Street, New York  
Wholesale Distributors  
SOBSING BRANCHES:

Boston, 46 Cornhill St. San Francisco, 591 Mission St.  
Baltimore, 11 N. Eutaw St. Chicago, 538 S. Dearborn St.  
New Orleans, 740 Union St. Seattle, 67 Columbia St.

**WANTED!**

Radio Experimenters to earn money in spare time by securing subscriptions to RADIO on a liberal commission basis.

Write today for  
full details to

**EASTERN SALES DIRECTOR**

Suite 212, McCrory Bldg., E. E.  
Pittsburgh, Pennsylvania

**RADIO FREQUENCY AMPLIFIER**

For Loop Reception—Complete with Tuning Condenser and Detector, \$125.00

**UNIVERSAL RADIO AND RESEARCH COMPANY**

199 S. Fair Oaks Ave., Pasadena, Cal.

Write for descriptive circulars.

Tell them that you saw it in RADIO



# The Book You Need C. W. MANUAL

By Jennings B. Dow, U. S. N.

**\$1.00** Per Copy  
POSTPAID ANYWHERE

A Complete Textbook  
Containing 112 Pages  
of Valuable Data on  
Vacuum Tube Transmitters

**T**ELLS you how to construct various types of radio telephone and telegraph continuous wave sets. Many diagrams and illustrations. Nothing like it on the market. Acknowledged by the better class of radio men to be one of the best radio books yet published. Get a copy from your dealer or order direct.

## The Following Dealers Carry The C. W. Manual

- Heintz and Kohlmoos,  
San Francisco
- Leo J. Meyberg,  
San Francisco
- Radio Institute of America,  
San Francisco
- Western Radio Electric Co.,  
Oakland, Calif.
- U. C. Battery & Electric Co.,  
Berkeley, Calif.
- J. C. Hobrecht & Co.,  
Sacramento, Calif.
- Western Radio Elec. Co.,  
Los Angeles, Calif.
- Paul F. Johnson,  
Pasadena, Calif.
- Southern Electric Co.,  
San Diego, Calif.
- Northern Radio & Elec. Co.,  
Seattle, Wash.
- Western Radio Distributing Co.,  
Seattle, Wash.
- Pacific Telegraph Institute,  
Spokane, Wash.
- John W. Graham & Co.,  
Spokane, Wash.
- Nielsen Radio Supply Co.,  
Phoenix, Ariz.
- Erie Book Store,  
Erie, Penna.
- Mutual Telephone Co.,  
Honolulu
- Wm. Guard & Co.,  
London, Ontario, Canada

**DEALERS** ORDER A SUPPLY  
OF THESE BOOKS

Write for Trade Prices

**PACIFIC RADIO PUB. CO., Inc.**  
Pacific Building — San Francisco  
17 West 42nd St. — New York

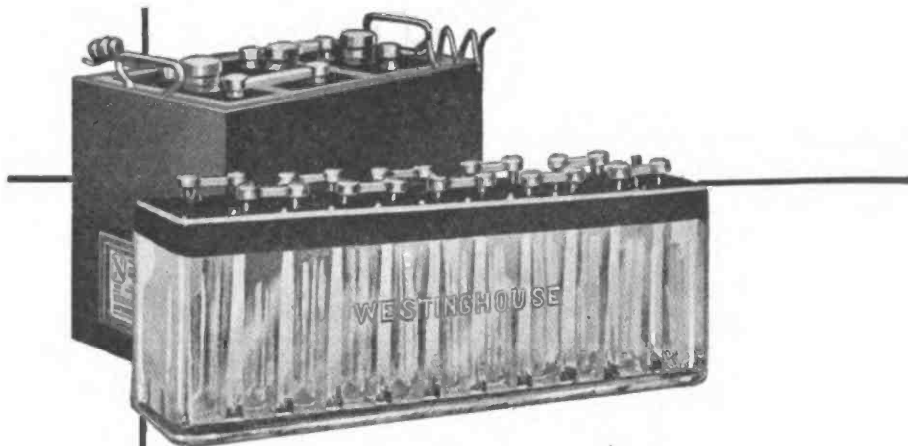

**Built by Westinghouse  
—you know they're right**

Nothing about a radio set is so absolutely essential to satisfactory receiving as *right* batteries. Westinghouse Batteries are not only correct in design, but durable in construction and thoroughly dependable in performance.

**WESTINGHOUSE "A" BATTERIES** are full-capacity, low-voltage, slow-discharge, long-life batteries, built especially for radio work. Ten types—27 to 162 ampere hours' capacity; 4, 6 and 8 volts.

**WESTINGHOUSE "B" BATTERIES.** The new Westinghouse 22-MG-2 is a rechargeable 22-volt "B" battery and a marvel for steady, noiseless, full-powered service. Glass case; visible interior. Lasts indefinitely. Two other types.

At your radio dealer's, or most any of the  
2000 Westinghouse Battery Service Stations

WESTINGHOUSE UNION BATTERY CO., Swissvale, Pa.

# WESTINGHOUSE RADIO "A" and "B" BATTERIES



# FROST FONES

Send Us 3 Subscriptions  
to "RADIO" and Get a  
Pair of Phones.

**FREE**

Standard 2000 ohms.  
Receivers.  
Fully Guaranteed

**"RADIO" Pacific Building, San Francisco**

Tell them that you saw it in RADIO

**THIRD  
EDITION  
NOW  
READY**

# AMATEUR RADIO CALL BOOK

**ALL UNDER ONE COVER**

An Official List of all Amateurs, Special Amateurs and Broadcasting Stations of United States and Canada.

—ALSO—

A large map, size 24" x 36" printed in two colors, showing location of every Broadcasting Station in United States and Canada and each district.

—AND—

How to Construct and Operate A Honeycomb Coil Set and Two Step Amplifier.

**PRICE \$1.00 COMPLETE**

(DO NOT SEND STAMPS)

Order from your dealer—If your dealer hasn't them, send direct.  
DEALERS WRITE FOR PROPOSITION!

**RADIO DIRECTORY & PUBLISHING CO.**  
45D VESEY STREET, NEW YORK, N. Y.

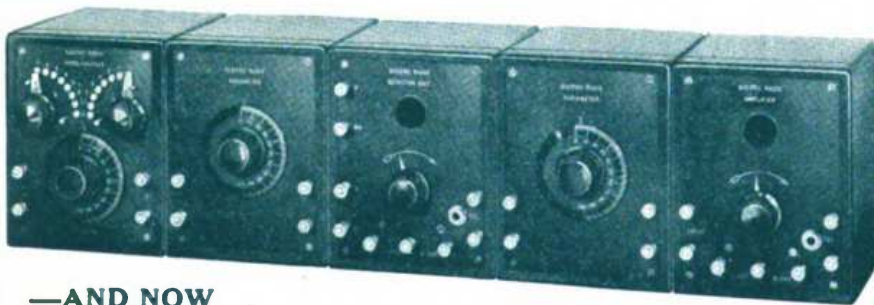

—AND NOW

## THE QUEENS FIVE UNIT SYSTEM

Following in the popular wake of the Queens "Green Tag of Perfection" Variometers and Variocouplers, comes the Queens Five Unit System—a "Green Tag of Perfection" complete vacuum tube receiving outfit.

Popular demand is the reason for this. Radioists nation-wide requested it—so we perfected it for radioists, expressly to receive broadcasting.

The five units complete, embody a Queens Variocoupler in a single unit—two Queens Variometers in a unit each—a detector unit and a one step amplifier unit. Each unit is constructed of solid genuine mahogany with genuine bakelite panels. The binding posts are solid brass triple nickel plated. New style knobs are uniformly used throughout, made of genuine bakelite with dials to match. Size of each unit is 5½" wide x 7¼" x 5½" deep. The five unit set sells for \$70.00, minus batteries and tubes. Additional steps of amplification may be added for a loudspeaker.

From end to end, every inch of these units are manufactured right in our own factory. This fact and huge production account for the popular low price. In line with Queens requirements, each unit is personally inspected and tested by our engineers before being shipped from our factory. After this, the "Green Tag of Perfection" is placed upon each. This is your protection and our guarantee—look for it. Every unit leaves our factory individually packed in cartons, neatly labeled. Every label carries a complete description of the contents.

Units also sold individually:

Variocoupler Unit .....\$15.00  
Variometer Unit .....\$12.50

Detector Unit .....\$12.50  
Amplifier Unit .....\$17.50

Write today for our valuable catalog showing our complete line of "Green Tag of Perfection" radio apparatus, together with attractive prices. It's free.

**QUEENS RADIO COMPANY, INC.**  
WINFIELD, L. I.

### Memorize Code in Three Hours

by the Corydon Snyder Code Method

Guaranteed: If you fail to memorize the code by this method after trial, return instructions within one week and money will be refunded. Send \$1.00 to Corydon Snyder, 1161 S. Ridgeland Ave., Oak Park, Ill.

Proposition to dealers; write

**JOY-KELSEY CORPORATION**  
RADIO EQUIPMENT  
4021 West Kinzie St. Chicago Ill.

Tell them that you saw it in RADIO

### EXIT "KUSD"

Continued from page 10

At 7:20 with daylight full on, KPH snapped a query across the intervening space:

"Is the fire any worse?"

"About the same," retorted Bell nonchalantly.

By 8:00 the whole coast knew what was happening out in mid-ocean. Here and there distant boats had started a call, only to be shut up by KPH, NPG or some other station or boat, aware of the desperate struggle that the *City of Honolulu* was making. Gradually the facts became known. Ashore, marine agencies, shipping interests, hundreds of radio operators—amateur and professional—were at their instruments, listening, listening . . .

Sharply at 8:30 a.m. there came the little three-letter call from KUSD that sent a shiver up the spine of every man that heard it:

"SOS! SOS! SOS!"

It was followed by a direct call to "WMN" and a repeated position enumeration, "WMN"—the *Enterprise* answered immediately, the operator having been waiting momentarily for that very thing.

"Come to our aid!" came Chief Operator Bell's imperative command from the distant, burning *City of Honolulu*.

"Coming!" replied the *Enterprise* laconically.

The listening world knew the fire was bad then—visualized the situation, heard the answer. Into every brain crept a picture of that pillar of flame, licking avidly around the helpless human freight, and the *Enterprise*, swinging about in its course and racing to the assistance of the doomed liner, with forced draught and "full speed ahead" on its engine-room dial.

And a desperate time indeed was being experienced aboard the *City of Honolulu*. With the vessel tilted away over on its side and the ship itself threatening every minute to turn turtle, the work of launching the life-boats had begun. One by one, they were loaded up and swung clear—down into a sea that was mercifully calm, and reasonably smooth. There was no mishap—a tribute to the efficiency and training of the crew and the coolness of the ship's officers. Afterwards, when all the facts came out, it was learned that there had been no panic.

Again, later, on the air, came the flash from the burning vessel:

"*Enterprise*—are you coming?"

"Yes—how is it?"

"Lowering boats now—very bad fire . . ."

Excitement sprang to a fever heat in all directions. Practically all radio business on the coast suspended. Would

Continued on page 74

# Sensational Xmas Offer

## Standard Cunningham Detector and Amplifier Tubes Given Free as Xmas Premiums For Securing Subscriptions to "RADIO"



**Cunningham Type C - 301 Amplifier Tube Given Free with Only Three Subscriptions to "Radio"**

### You Get a Detector Tube Free With Only Two Subscriptions

Every year the publishers of "Radio" have done something for the readers of the magazine. This year we are doing more than ever. We are going to present you with a Genuine Vacuum Tube if you secure subscriptions for us. You get a \$5.00 Tube Free for securing \$5.00 Worth of Subscriptions. \$10.00 worth of Radio usefulness for only five dollars. The Amplifier Tube is Given Free with three Subscriptions.

*We have only a limited supply of Tubes on hand. Order early. Shipments made on Day Orders Received.*



**Cunningham Type C - 300 Detector Tube Given Free with Only Two Subscriptions to "Radio"**

### Mail the Coupon Right NOW and Make Your Merry Xmas Still Merrier

*The Offer Expires on Dec. 24th.*

"RADIO", Pacific Building, San Francisco  
Herewith is \$..... and 25c for mailing charges. Send "RADIO" for one year to each of the following:

Name..... Address.....

Name..... Address.....

Name..... Address.....

Send Premium to.....

Tell them that you saw it in RADIO



125A—RADIO RECEIVER AND AMPLIFIER.....\$125.00  
 Double circuit, using primary condenser; detector; two stages of audio and one radio frequency. A solid mahogany cabinet. A highly efficient long distance set. Range 200 to 700 meters.

## CARDWELL Stands for Quality RADIO

Allen D. Cardwell has been a manufacturer of High Grade Radio Apparatus since 1913. His activities heretofore have been confined to the development and manufacture of Radio Apparatus for the United States Government and many of the leading commercial Radio Telegraph and Telephone Companies.

Our Complete receiving sets and parts are manufactured with unusual care and subject to the most rigid supervision and inspection.

A sales policy that permits of a liberal discount has been worked out that will insure sufficient profits for the jobber and dealer.

### A COMPLETE LINE

Complete Receiving Sets	Rheostats	Amplifiers	Meters
Variable Condensers	Dials	Coils	Jacks
Transformers	Knobs	Switches	Relays
	Telephone Receivers		

**NOTE:** We desire a few of the best radio distributors on the Coast to represent our line. Our proposition is attractive to those desiring a high class product.

### The Allen D. Cardwell Mfg. Corporation

Dealers' and Distributors' Discounts on Request

81 PROSPECT STREET  
 BROOKLYN, N. Y.

## For CORRECT RADIO MAILING LISTS Use

### THE POCKET LIST

Of Radio Manufacturers, Jobbers and Dealers in the United States and Canada. Issued quarterly—January, April, July and October. October, 1922, issue corrected to September 15, 1922. Classified under three different headings—manufacturers, jobbers and dealers—and alphabetically arranged by states, cities and towns and names of firms. Containing over 15,000 names and addresses.

We have been exceptionally careful to see to it that every manufacturer, jobber and dealer is listed and under the PROPER CLASSIFICATION. Most mailing list concerns charge more than \$100 for a list of this kind, and, as a rule, those supplied are far from being correct. Compare this list with any other and you will find it to be the very best obtainable anywhere at any price.

October number ready for distribution September 25th. Price \$5.00 per copy or \$10.00 per year (four issues, including monthly supplements which keep the list absolutely correct and up to date at all times). October edition limited, send in your order with remittance today.

F. D. PICKENS

1021 Carrington Street

JANESVILLE, WISCONSIN

Tell them that you saw it in RADIO

Continued from page 72

the *Enterprise* reach the scene in time? Would the race be of any avail whatever? Was another grim tragedy of the sea being enacted, out of reach of human help? These questions flitted through the heads of more than one radio operator, and no answer came out of the ether in reply.

Three minutes after 9 o'clock came another radio laconic from the *City of Honolulu*—from the unshakable operator on duty sitting unconcernedly above a seething furnace:

"Leaving ship any minute now . . ."

Bell's hand was steady, despite the angle at which he was working and the orderly excitement all around him. His assistants no longer relaying with the bridge, were helping with the work of loading the life-boats. The radio was his alone . . .

At ten minutes to 10 o'clock he sent the *Enterprise* a message that will live long on the Pacific Coast—a message that tells better than the ethical dissertations of a radio instructor the correct perspective of a wireless operator's job:

"All left but the captain, chief officer, chief engineer and myself . . . !

On the heels of this, a shore station offered him a message addressed to Captain Lester. Bell accepted it, with his operating table pointed toward Neptune's locker. A moment later, his spark was again on the air to KPH—the answer trotting steadily out of the smoke billows that lay like a pall around his ship. And then . . .

"Leaving ship now, GB, . . . ."

The most dramatic farewell ever recorded in the history of Pacific wireless! Terse, simple—he "kissed off" a fine deed of loyal service, with a casual "sine," as though departing from burning ships was a matter of daily routine. That final tag on the end of that last message from the *City of Honolulu* will remain long in the memories of those who heard it.

The rest of the story is marine history—the floating of the lifeboats on the silent sea, awaiting the arrival of succor, the message that turned the freighter *West Farallone* about, to pick up the little colony of twenty boats at 4 o'clock that afternoon, and their transfer to the more commodious *Thomas* at dawn the next day, and safe landing a few hours later at Los Angeles.

Out of the episode two paramount features stand forth—the remarkable record of the radio, through whose efficiency the entire ship's personnel and its passengers were saved with much of their personal property, due to the rapidity and efficiency of the Radio Corporation's invisible network of wireless protection, and the sterling per-

Continued on page 76

*If You Have a Radio Enthusiast in the Family---Put This on The Tree*

## PACENT TWINADAPTER

An ingenious device for providing two plug connections for a single jack. This permits the use of two sets of head phones, or one set of head phones and a loud speaker. The radio experimenter will find many uses for the TWINADAPTER.

Price, \$1.50

PACENT Radio Essentials embody the highest radio engineering skill and over fifteen years' practical radio experience. They are used and endorsed by experts and are standard equipment with leading set manufacturers.

The TWINADAPTER is just one of many PACENT devices for convenience and pleasure in radio. Ask your dealer to show you other members of the PACENT line, or

Write for Descriptive Bulletin MD103

**Don't Improvise—"PACENTIZE"**

## PACENT ELECTRIC COMPANY

INCORPORATED

Manufacturers and Distributors of Radio and Electrical Essentials  
Executive Offices: 22 Park Place, New York, N. Y.

BRANCH OFFICES

Philadelphia, Bourse Building  
Chicago, 33 So. Clinton Street  
Members, Radio Section, Associated Mfrs. of Electrical Supplies



Washington, D. C., Munsey Bld.  
San Francisco, Sheldon Bldg.  
Canadian and British Licensees:  
Colonial Radio, Ltd., Hamilton,  
Canada

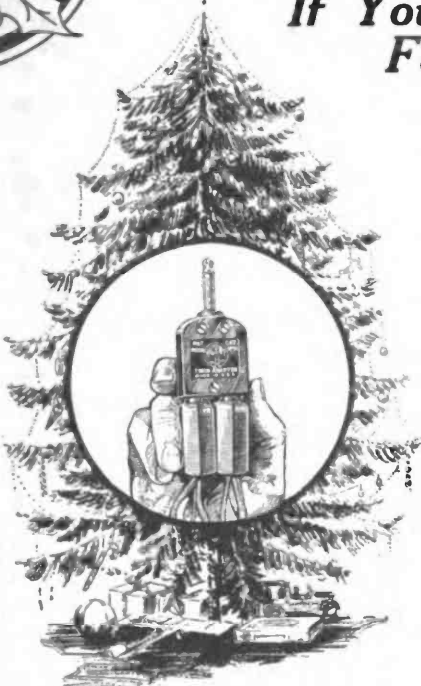

*If you buy a receiving set for a gift, be sure it is "PACENTIZED."*

*"This is a Radio Christmas"*

# DECEMBER RADIO SPECIALS

**No orders sent C. O. D.**  
All Apparatus is the Newest Latest Models

## Clapp-Eastham Sets

**Send Stamps, Check, Money or Money Orders**

Licensed under Armstrong U. S. Patent

Regular Price	ABREESTERS	Sale Price
\$2.50	Brach Inside Type Approved	\$1.75
3.00	Brach Outside Type Approved	2.75
2.00	Keystones Approved	1.75
3.75	100 A 600 V. Comp. Base Switches	2.00
AMMETERS		
6.00	Radio Corp. 0-25 A Hot Wire	4.10
6.25	Radio Corp. 0-5 A Hot Wire	4.00
BOOKS		
2.25	Practical Wireless Teleg.	1.50
2.50	Prepared Radio Measurements	1.50
2.25	Radio Telephony	1.50
2.25	Wireless Experimenters' Manual	1.50
1.50	Radio for Everybody	1.10
.35	Lessons in Wireless Teleg.	.25
.35	Experimental Wireless Const.	.25
.35	Operation of Wireless Teleg.	.25
.75	Radio Hook Ups, by Sleeper	.59
.75	How to Make Commercial App.	.59
.50	Const. Plans No. 1 and No. 2, each	.39
BINDING POSTS		
.18	Hard Rubber Top Large	.08
.12	Hard Rubber Top Med.	.10
.10	N. P. Brass 5/16 Diam.	.05
.12	N. P. Brass 11/32 Dian.	.05
COILS		
11.40	R 22 Signal Arlington Coupler	8.00
8.50	R 23 Signal 2000 meter Coupler	6.25
5.40	R 27 Signal Tuning Coil	5.00
5.00	Whitall Variocoupler	3.00

Regular Price	Type "HR" Regenerative Receiver—180 to 825 meters—solid mahogany cabinet.	Sale Price
	Regular Price Special Price	
	\$40.00 \$25.00	
Regular Price	Type "HZ"—Two-stage Amplifier, a companion piece to the "HR"	Sale Price
\$35.00	"HR" Sets, oak cabinet, special	\$22.00
\$85.00	"HZ" Sets, oak cabinet, special	\$22.00
THE IDEAL RECEIVER		
	Type "RZ"—Solid Mahogany Cabinet. The latest model made.	
	"BADAC"	
	A combination of the types "HR" and "HZ". 175 to 3000 meters.	
	Regular Price Special Price	
	\$100.00 \$65.00	
	Opportunities like this only come once. Act now—don't delay!	
Regular Price	CONDENSERS	Sale Price
2.25	Fesco 3 plate variable	1.65
3.25	Fesco 11 plate variable	2.40
4.00	Fesco 21 plate variable	3.00
4.75	Fesco 43 plate variable	4.00
.35	RTL Fone Fixed .001	.25
.35	RTL Grid Fixed .005	.25
.35	RTL Grid Fixed .0025	.25
.50	G. A. Grid leak Meg. .0005	.30
.35	G. A. Grid .005	.25
.35	G. A. Phone .0025	.25
.70	Paragon Moulded .001	.50

Regular Price	PHONE CORDS	Sale Price
.80	Double 5 feet cords	.35
.50	Single 5 feet cords	.25
PHONES		
7.75	Baldwin "C" units	6.00
PLUGS AND JACKS		
1.25	Frost plugs for tips	.75
.70	Open Jacks Federal	.55
.85	Closed Jacks Federal	.60
1.00	2 circuit Jacks Federal	.80
1.20	1 circuit Fil. Cont.	1.00
1.50	2 circuit Fil. Cont.	1.20
BOTOBS		
.75	Composition 8 11/16 Diam.	.50
SWITCH POINTS AND LEVERS		
.50	Paragon Switch Levers	.25
.50	Whitall Switch Levers	.35
.03	Switch points 1/4x1/8 per doz.	.10
.05	Switch Stops	.02 1/2
SOCKETS		
.75	Whitall No. 707 Bakelite	.50
1.00	Whitall No. 706 Square	.50
MAGNET WIRE, DOUBLE COTTON COVERED; 1/4 pound spools		
.35	No. 18 D.C.C. Price per spool	.29
.35	No. 20 D.C.C. Price per spool	.31
.45	No. 22 D.C.C. Price per spool	.34
.50	No. 24 D.C.C. Price per spool	.38
.55	No. 26 D.C.C. Price per spool	.47
.65	No. 28 D.C.C. Price per spool	.55
.85	No. 30 D.C.C. Price per spool	.60
.60	No. 23 S.S. Price per spool	.50
BUZZER SETS		
2.70	Signal Key and Buzzer	2.00
.80	High Pitch Buzzers	.60

**THE WHITALL RADIO CO.**

Illustrated Catalogue and Code Card Sent Free With Every Order

**Springfield, Mass.**

Tell them that you saw it in RADIO

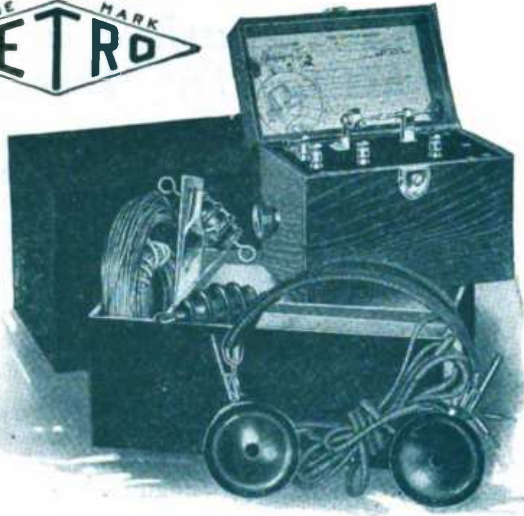

## The LITTLE GIANT Receiving Outfit

**RADIO FOR EVERYBODY**

**Simplified — More Efficient — Lower Priced**

IN LESS than a half hour after you bring home this magic box, the family can listen to the radio programs of music, entertainment and instruction. You don't need to know how it works or anything about radio. All you do (once the detector has been adjusted) is pull out the easy sliding rod on the side of the Little Giant Set until the sounds come in strong and clear.

Costs nothing to maintain. Nothing to get out of order. Encased in a neat American Walnut cabinet with a polished black composition panel board and all metal parts heavily nickel plated—the Little Giant Set is a very attractive article.

Complete in every detail. Nothing more needed. Metro headphones, expressly made to coordinate with the Little Giant, are extremely sensitive. The Little Giant Set, Metro Headphones and aerial complete, neatly packed in black leatherette box for only.....

### Complete Outfit

With Metro Headphones, Aerial, Insulator, Ground Wire and Ground Clamp, packed in black leatherette box.

**\$15**

**Dealers! Sell Something Everybody Is Buying.**

## Metropolitan Radio Corporation

67-71 Goble St.

Newark, N. J.

## Hear Radio Right!

Starnes Superadio Specials, same as used by Harry T. Starnes in his lecture-demonstrations on Chautauqua and Lyceum Circuits in United States and Canada, under all conditions. 2500 mile receiver, two stages, piano finish mahogany cabinet.....\$200.00  
Two stage radio frequency amplifier, the best.....\$75.00  
Detector, and one stage audio frequency amplifier.....\$40.00  
Detector, and two stage audio frequency amplifier.....\$60.00  
With automatic filament control.....\$60.00  
Clapp-Eastham, Westinghouse, and other standard outfits at regular prices.

**Starnes Superadio Service, Covington, Indiana**

## Dubilier DUCON Plugs

**FREE** SUBSCRIBE TO "RADIO" FOR ONE YEAR AND WE WILL SEND YOU A GENUINE DUCON. "RADIO." Pacific Bldg., San Francisco, Calif.

Continued from page 74

formance of the radio operators through whose coolness and loyal service, given without regard to personal danger, another grim tragedy of the sea was averted.

But above these two circumstances, is one other factor which should be of interest to every radio fan who reads this, namely, that the men who carved this little record of radio history were amateurs—students of radio, the so-called "tinkerers" and experimenters of the barn and woodshed, who grew up with the "game," learned it in their kid days, graduated into professionals, and faced grave responsibility and possible death, remained faithful to the ideals of the craft.

The burning of the *City of Honolulu* is ranked as a marine loss. But it is an epical gain—for the cause of amateur radio—a justification for all the hours, time and money spent in its pursuit and development. For to the perfected faith of three amateurs, two hundred and sixty-two persons owe their most ultimate debt—their lives!

### NEW LAND WIRELESS SYSTEM IN JAPAN

Application for government sanction to establish a wireless telephone system has been made by the Daido Electric Power Company, of Nagoya, Japan, according to advices received by the Department of Commerce. The company proposes to operate this wireless system primarily for its own convenience in connecting the various stations with its electric light and power system, but its use may be extended eventually to the general public if sufficient demand should arise.

### Save Your "A" Battery

By a Quick Weekly Check-up with the "Chaslyn" Sink-or-Swim Ball Tester Set.

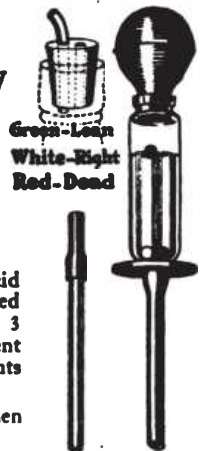

Condition of acid instantly disclosed by the way the 3 balls of different colors and weights sink or swim.

Won't Break when dropped.

Depth of acid tested by Depth Gauge. Distilled water added neatly with air-controlled rubber-stopper.

Set of 3 as illustrated, \$1.00. Order from your Dealer. If he tries to sell you something else, send his name and address and your dollar. Set will be mailed postpaid.

## CHASLYN CO.

4309 Kenmore Ave. Chicago, Ill.



# RADIO FREQUENCY

Tuner, Detector and Amplifier for only . . . . \$ **30**<sup>00</sup>



Let Ross do it

Build your own set and buy the parts from us. Tell us what kind of a set you want to build. We will quote prices.

## Build Your Own!

We will send you the following parts required for constructing the set:

- |                  |                     |
|------------------|---------------------|
| 2 Variometers    | 1 R. F. Transformer |
| 2 Rheostats      | 2 Sockets           |
| 2 3/16" Dials    | 1 23 Plate V. C.    |
| 1 Potentiometer  | 1 A. F. Transformer |
| 1 C-300 Detector | 1 C-301 Amplifier   |

Also a complete wiring diagram

Any Parts for This Set Sold Separately

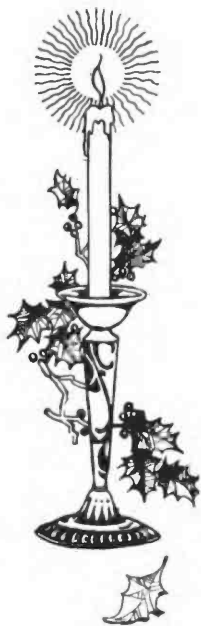

ROSS RADIO SERVICE  
Extends Cordial  
Xmas Greetings  
to You

Get your name on our free Mailing List. We will send you our Bulletins regularly



We have a large stock of standard supplies on hand. Our mail order department is equipped to take care of your orders within one hour after we receive them. Consult us first before you buy. Send the coupon for our price list.

**ROSS RADIO SERVICE**

Name .....

Address .....

SEND ME YOUR FREE BULLETINS AT ONCE.

693 MISSION ST.,  
San Francisco, Cal.

# "REGAL" PRECISION BUILT RADIO PRODUCTS ARE MADE TO SERVE AND SATISFY

Their Reputation in the Radio World Is Built on Quality



## "REGAL" PRODUCTS

Vacuum Tube Receivers.  
Crystal Detectors.  
Condensers.  
Vario Couplers.  
Variometers.  
WRITE for catalog No. 14, showing our complete line.



## Filament Rheostat

Has full exposed resistance wire, giving critical adjustment so necessary to the efficient operation of a vacuum tube. Fine, smooth working control. Handsome knob, heat resistance base and highly nickel plated parts. 6 ohms resistance—2.2 amperes **\$1.25**

## Inductance Switch with Knob and Dial

A 15-point switch complete in one unit. Requires but one hole to mount on panel. Smooth wiping contact over heads machined to same height on one piece contacts. Complete soldered assembly attached, or removed from panels by means of one threaded shaft bushing. Gives inductance regulation by **\$2.00** dial contact

**WANTED:** High grade distributor for San Francisco and Los Angeles territory. An excellent proposition.

AMERICAN SPECIALTY MFG. CO., Bridgeport, Conn.

## RADIO TUNING DEVICES

Continued from page 12

crease the damping of the oscillations in the antenna circuit. So far as damping is concerned, then, an increase in coupling between the primary and the secondary circuits, by the inclusion of more turns common to both circuits, is equivalent to the insertion of resistance in the antenna circuit.

We learned in the last assignment and in this one also that the insertion of resistance in the antenna circuit of the receiver, with a consequent increase in damping in the antenna current, broadens the tuning of the receiver or makes it less selective. That is to say, if we increase the damping of the current in the antenna circuit of the receiver by increasing the coupling between the primary (antenna) and secondary circuits, we tend to decrease the sharpness of tuning in both circuits. This is a decided disadvantage in attempting to eliminate interference, since the receiver will respond to waves of more than one frequency for any particular tuning adjustment.

The advantage of the two-slide tuner, therefore, is not that we can tune both circuits to resonance, since this can as easily be accomplished by the single-slide tuner with variable condenser shown in Fig. 28, but that we can vary the coupling between both circuits and hence can increase or decrease the sharpness of tuning of the receiver at will.

In practice, then, we should first adjust the slider controlling the tuning of the primary circuit, slider 1, until the signals are loudest. The secondary should then be adjusted by means of slider 2, with the variable condenser set a low value of capacity, until the signal strength is at a maximum. If the tuning is broad, i.e., if the setting of the slider is not critical, slider 2 should be moved toward the antenna end of the tuning coil. This reduction of the secondary portion of the inductance from the resonant value will decrease the signal strength but the latter may be increased to its maximum value by increasing the capacity of the variable condenser. Slider 1 in the antenna circuit may now require slight readjustment. Then the tuning will be much more sharp or critical and interference from stations operating on other wavelengths will be greatly reduced, if not eliminated.

Obviously, you should not attempt to use too few turns in the secondary, since there will not be enough turns intercepted by the primary flux to induce a sufficient potential across them. If too many turns are used in the secondary, the tuning will be very broad. Experi-

Continued on page 81

DECEMBER

# EMPIRE RADIO

BULLETIN

TUNER  
\$25



R. F. AMPLIFIER  
\$14

DETECTOR  
\$6

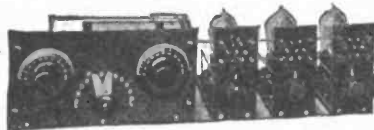

A. F. AMPLIFIER  
\$14

The Tuner and Detector make a complete Radio Receiving set. The Audio and Radio Frequency units may be added, at will, to enlarge the outfit, so that receiving can be accomplished without the use of an out-door aerial.

Dealers and jobbers write for attractive proposition. Amateurs send 10c for our new and complete catalog

## EMPIRE RADIO CORPORATION

Manufacturers and Distributors of Radio Apparatus

271 West 125th Street

New York City

## HYGRADE SPECIALS

7-stranded Copper Aerial Wire, 200 ft.	\$ 1.00
Electrose Insulators (per dozen)	2.00
No. 763 Eveready Variable B. Battery	1.25
No. 766 Eveready Variable B. Battery	2.25
No. 767 Eveready Variable B. Battery	4.25
45 Volt Cyclone Variable B. Battery	2.50
Arkay Loud Speaker	3.89
Thordarson Amplifying Transformers	3.49
Acme Amplifying Transformers (mounted)	4.00
Federal Amplifying Transformers	5.95
Skindervikin Transmitter Buttons	.75
Firco Bull Dog Grip Phone Plug	.98
2000-Ohm Murdock No. 56 Head Set	4.49
3000-Ohm Murdock No. 56 Head Set	4.98
Federal 2200-Ohm Head Set	6.50
Dictograph 3000-Ohm Head Set	7.50
Western Electric Head Set	10.50
6 volt 30 amp.	9.25
6 volt 60 amp.	12.95
6 volt 80 amp.	16.95
6 volt 100 amp.	21.00

Above prices are F. O. B. New York

HYGRADE ELECTRICAL NOVELTY CO.  
41 West 125th Street, New York, N. Y.



## NA-ALD

genuine  
Condensite Dial

The dial that runs true.

Numerals engraved on bevel and knob so shaped that fingers do not hide them. Thin edge with clear graduation to make accurate reading easy. Concealed set screw in metal insert. Will not warp or chip. Finish and enamel permanent.

3" dial, 35c  
2" dial for rheostat potentiometer use, 35c  
3 3/4" dial, 75c

Send stamps for literature  
**ALDEN-NAPIER COMPANY**  
52 Willow St.—Dept. H—Springfield, Mass.

:: Read the RADIOADS on Page 111 ::

Tell them that you saw it in BADIO



# What's in the Name **Cotoco?**

TRADE MARK REG. U. S. PAT. OFF.

## Radio Supplies Made for Better Results

Designed by an organization of Electrical and Mechanical Experts. Made to supply the needs of those amateurs and professionals in radio who know and demand the best. You will find Cotoco Products displayed by those wiser dealers who are building permanent business on radio supplies that give maximum results and by keeping abreast of the latest developments in radio—namely, radio frequency and loop aerials.

We were the first makers of coils of this type. Here is your compact, economical inductance. Mounts on fixed or trunnion brackets.

### *Designed for Electrical Efficiency and Made a Fine Machine Product*

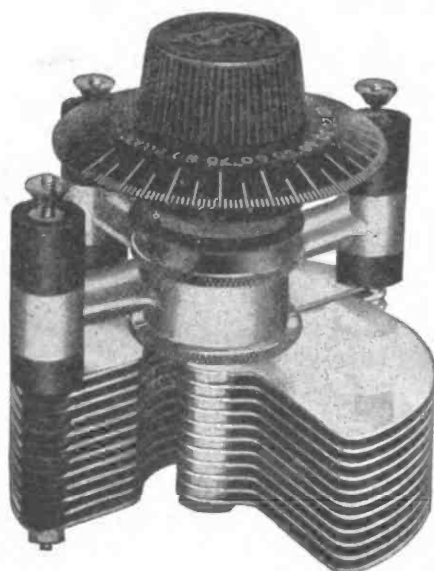

Cotoco Variable Air Condensers are scientifically correct to minimize electrical losses. We have tested many condensers, but have never found their equal.

Works just as smoothly as a fine watch, because it's made as well.

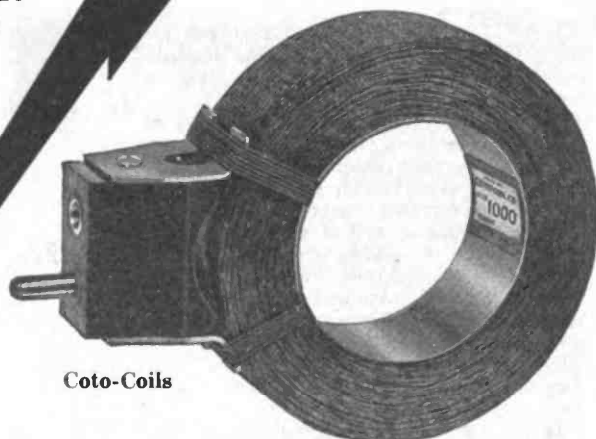

Cotoco-Coils

You can tell by its looks alone that it is a precise instrument

### *Static and Distortion Banished Loop Aerials Available to All*

Beyond our most sanguine expectations, we have succeeded in overcoming Static and securing great range with Loop Aerials. Distortion in headphones or loud speaker is practically unknown with a Cotoco built set. Write for connection diagram.

#### **If Your Dealer Cannot Supply You**

Write us his name and address. We will see that you are supplied with

**FREE**

Connection Diagrams for Loop Aerial Sets using either two or three stages of Radio Frequency Amplification.

**Coto-Coil Co.**

87 WILLARD AVENUE  
PROVIDENCE, R. I.

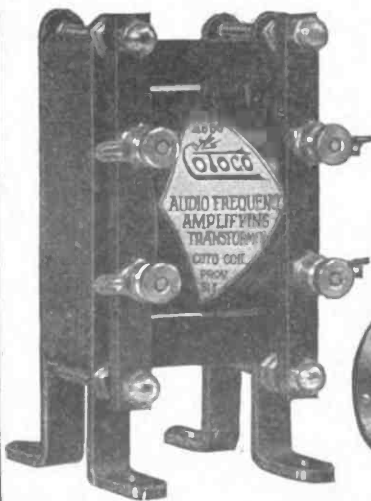

#### **Amplifying Transformer for Audio Frequency**

An excellent transformer for all kinds of amateur and professional work. Practically constant audibility with little or no distortion.

#### **Amplifying Transformer for Radio Frequency**

Tapped type. Extra selective. So most static is excluded. The key to Loop Aerial efficiency. Mount for one, two or three stages of amplification. (Illustration, two stages.)

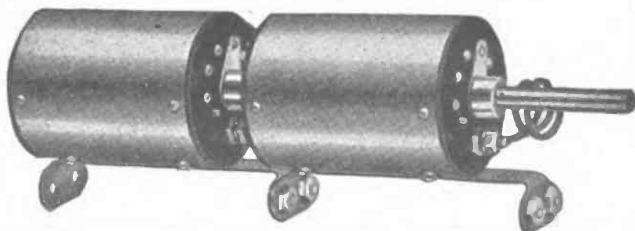

Tell them that you saw it in RADIO



# free Xmas gifts

## free!

Whenever somebody tells you that you are going to get something "free" you immediately form the opinion that "what you get for nothing amounts to nothing."

The publishers of "RADIO" are going to give you something for nothing—and our reputation is your assurance that you are going to get exactly what we offer you. We want to increase our direct mail circulation by many thousands and if you will help us in so doing we will reward you with genuine radio apparatus—*free*.

Several thousand premiums were mailed to our readers this year alone. Our big Xmas offer is the most liberal yet made. Carefully read the conditions of this plan and start the ball rolling in your town by rounding up subscriptions to "RADIO."

The manufacturers of the premiums and the publishers of "RADIO" stand back of every piece of apparatus that we send you. You can't go wrong. Get something for nothing. Show this issue of "RADIO" to your friends and get them to subscribe.



LET us give you one of these WorkRite Loud Speakers absolutely free for Christmas.

They are ideal for concert reception.

A little effort on your part is all that is necessary to get one.

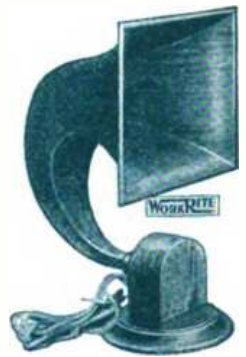

### Offer No. 1—

The WorkRite Concertola, as illustrated, will be given to you absolutely free of charge for securing twelve subscriptions to "RADIO" for one year each. The Concertola retails for \$24.00. It is made from the finest grade mahogany. Hand-rubbed finish. No metal used for the horn. A special 5000 ohm phone is built into the cabinet. This is a most desirable Xmas gift. Send us 12 subscriptions and we will immediately forward one of these Concertolas by express.

### Offer No. 2—

The WorkRite Concertola without cabinet, as illustrated. Given free with only six subscriptions to "RADIO" for one year each. This is really a remarkable offer. The instrument is beautifully finished in mahogany. Distortionless reproduction of signals. Equipped with special 5000 ohm receiver that cannot be purchased separately. Enjoy your broadcast concerts by installing one of these Concertolas. Why not give it to your radio friend for XMAS? Radio supplies and radio magazine subscriptions are ideal holiday gifts.

## TRUTONE LOUD SPEAKER FREE WITH THREE SUBSCRIPTIONS

So great has been the demand for the popular Trutone Loud Speaker that we are going to offer an additional supply of them to our readers for Xmas gifts with subscriptions. This loud speaker is advertised in "RADIO" under the name of the Sadler Manufacturing Co. There are two types—single phone and double phone. You may have either type if you send us three subscriptions to "RADIO" for one year each. Hundreds of satisfied users have received these instruments. The price, if purchased from a dealer, is \$6.50. You get it positively free for three subscriptions. Be sure to include 60c for mailing charges.

### Your Order Must Reach Us By December 24th



RADIO  
Pacific Bldg.,  
San Francisco.

Here with is \$..... and ..... cents for mailing charges. Immediately send me the apparatus described in offer ..... and send "RADIO" for 1 year to the following: (Write additional names on separate sheets of paper if more than three subscriptions are sent.)

Name .....  
Address .....

Name .....  
Address .....

Name .....  
Address .....



Continued from page 78

mentation will soon show you the proper balance to have.

Fig. 30 shows a typical two-slide tuner, the only difference in its construction from that of the single-slide tuner being the addition of the second slider.

VARIABLE CONDENSERS

We have already discussed the operation and construction of the receiving variable condenser. It consists of a set of stationary plates and a set of movable aluminum plates insulated from each other by the air space between. The plates are so arranged that the movable plates may be revolved so as to interleave with the stationary ones. We have already learned that the capacity of a condenser is increased by enlarging the size of its metallic coatings and by decreasing the distance between them.

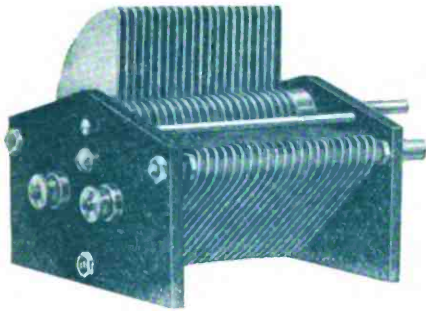

Fig. 31. Typical Variable Condenser.

When the movable plates—with respect to the stationary ones—are in the position shown in Fig. 17, the capacity of the condenser is almost zero, and would be zero if it were not for the electrostatic attraction exerted by the ends of the two opposing sets of plates on each other. As we revolve the movable plates within the stationary ones, we increase the capacity not because we are decreasing the distance between the plates, which is fixed, but because we are increasing the size of the plates—the size of the actively opposing areas.

Fig. 31 shows the appearance of a typical variable condenser. Since half of the movable plates are still unopposed to the stationary plates, this condenser is set at approximately half its maximum capacity.

ASSIGNMENT No. 6

LOOSE COUPLERS

In Figs. 22 and 24 were shown the schematic diagrams representing the receiving transformer or loose coupler. In the text accompanying those figures, we learned that a loose coupler consists of two coils inductively coupled to each other so that radio frequency current in one coil—the primary—can induce a potential across the terminals of the other coil—the secondary. Primarily, the function of the loose coupler is to serve

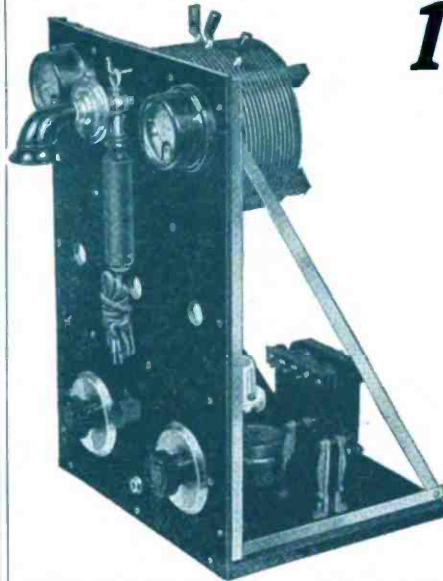

# 1500 Miles With CW!!

## 1100 Miles Voice!

Music Heard 40 Feet From Phones by Stations in 300 to 400 Miles Radius

These are actual results obtained by our testing station WEB, using the Benwood CW Transmitter shown herewith. You can get just as good results with it. This high-class set is just the thing for your broadcasting and DX work — using CW, ICW, Modulated Buzzer or Voice Transmission. An ideal set for the local radio club or the more progressive amateur. Think of the

range this set will give you! If centrally located, you will be heard in almost every state in the Union. It is manufactured exclusively by and for the Benwood Co. and combines the best in material, workmanship and design. We guarantee it to radiate 1½ Amps. on the average amateur antenna and 2 to 3 Amps. when used with an antenna whose fundamental wavelength is 225 to 275 meters. That's why you can get such wonderful results.

### Read This Testimonial

Broadcasting station WSN, the Ship Owners Radio Service, Inc., located at Norfolk, Va., wrote us on AUGUST 10TH (fine season for static) as follows:

Gentlemen: I thought possible you would be interested to know of the remarkable results we have obtained from the 15 watt Benwood Phone set we purchased from you.

We are only using 25 watt tubes in your set and on several occasions have been reported in Long Island, N. Y.; Phila., Pa.; Cape May, N. J., and Newman, Ga., which is approximately 700 miles from here. Our record was established last week by being reported by O. E. Krannich, 215 South

Street, Iola, Kansas, a distance of approximately 1000 miles.

The remarkable part of this occurrence is that this distance was covered under the most undesirable conditions as we are unable to erect suitable antenna or obtain a good ground. Our place of business is a one story building situated between two ten story buildings and there is certainly a great deal of current absorbed.

Yours very truly,  
O. S. MOCK.

The Benwood CW Transmitter is completely wired and set up. You can start sending as soon as you insert tubes and attach to ground and antenna. Complete, without tubes, \$350.00—if your dealer cannot supply you, write to us direct, giving us his name.

Ask Your Dealer For Benwood Radio Apparatus



1113 Olive St.

St. Louis, Mo.

## SPECIAL OFFER

Subscribe to "RADIO" for one year and we will send you one of the following free premiums:

Remler Dial, Socket, Rheostat or Grid Condenser  
Include 12c for mailing charges

"RADIO" Pacific Building SAN FRANCISCO

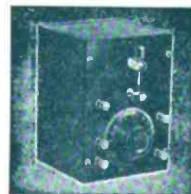

### STEINMETZ APPARATUS

STEINMETZ CRYSTAL SET \$9.50

A highly efficient set with an extremely neat appearance. Has bakelite panel with variometer tuning unit, all metal parts, nickel plated.

STEINMETZ crystal set unassembled, \$6.90  
STEINMETZ VACUUM TUBE DETECTOR UNIT, \$5.50; unassembled, \$3.90  
STEINMETZ detector and two stage, \$22.50; unassembled, \$16.80  
2000 ohm headsets, \$5.00; 8000 ohm, \$6.50; 1000 ohm phone, \$1.75

Catalog free at your dealer's, or STEINMETZ WIRELESS MFG. CO 5706 Penn Ave. Pittsburg, Pa.

### "EURACO PRODUCTS (Guaranteed)

Compact — Interchangeable — Accurate Most Efficient



Price 60 cents per Unit

Mfgs. of MICA CONDENSERS, GRID LEAKS, MOUNTINGS

Interesting Proposition for Dealers

European Radio Company 1342 East 22nd Street Brooklyn, N.

Tell them that you saw it in RADIO



**The Hit of Radio**

**New England Products**

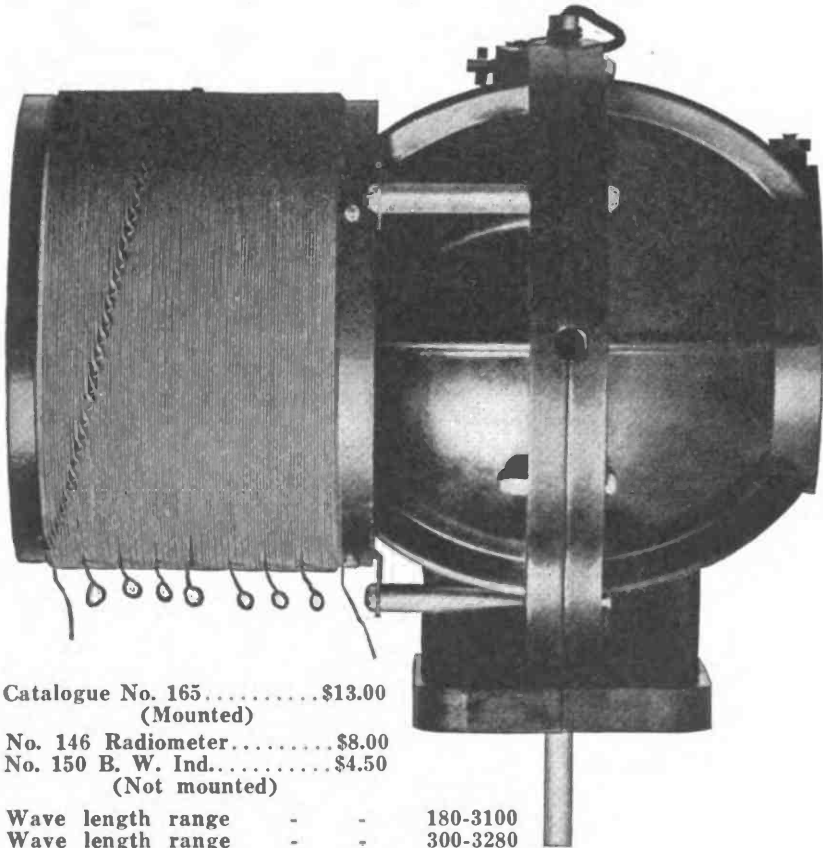

Catalogue No. 165.....\$13.00  
 (Mounted)  
 No. 146 Radiometer.....\$8.00  
 No. 150 B. W. Ind.....\$4.50  
 (Not mounted)  
 Wave length range - - 180-3100  
 Wave length range - - 300-3280

**R. MITCHELL & CO.**

**255 Atlantic Ave. Boston, Mass.**

*For 47 yrs. Mfrs. of Scientific and other equipment.  
 Look for trade mark on every piece.*

**Jobbers and Dealers, write for discounts**

**Balanced Variable Condensers**

From Manufacturer to Consumer  
 Plates 1/32" aluminum.  
 Turned brass spacers.  
 Nickel plated and polished.  
 Binding posts provided.



Money back if not satisfied  
 .001 Mfd., 44 plate, \$4.50  
 .0005 Mfd., 24 plate, \$3.50

A condenser that will put pep into your set!

**MONTROSE MFG. CO.**  
 1200 Bedford Ave., Dept. P  
 Brooklyn, N. Y.

**APEX SERVICE**

All orders shipped same date as received.  
 Try our service—you will like it. Price bulletin sent on receipt of 2c stamp.  
 Kellog Moulded Socket.....\$0.75  
 Apex Metal Shell Socket..... 1.00  
 Howard Rheostat (Panel Mounting) 1.10  
 Howard Vernier Rheostat..... 1.75  
 All American Amp. Trans. 10 to 1.. 4.50  
 All American Amp. Trans. 3 to 1.. 4.25  
 Thordarson Amp. Trans..... 4.50  
 R. C. Radio Frequency Trans.  
 UV1714 ..... 6.50  
 All American Radio Frequency  
 Trans. .... 4.50  
 Howard Potentiometer 200 ohms... 1.50  
 R. C. Potentiometer 200 ohms... 2.00  
 Remco Dial 3 in..... 1.00  
 Remco Dial 4 in..... 1.50

**Apex Radio Co., Inc.**  
 6914 South Halsted St., Chicago, Ill.

**YOU Should Be A Subscriber**

Tell them that you saw it in RADIO

as a means by which the detector can be coupled (inductively) to the antenna circuit so that its high resistance will not have to be interposed directly therein. As we have previously seen, it is of great advantage to couple the detector to the antenna, instead of directly connecting it therein as shown in Fig. 21, since the elimination of its resistance from the antenna decreases the damping of the current in the antenna circuit. By decreasing the damping of the received antenna current, we increase the sharpness of the receiver tuning which tends to reduce interference from stations operating on wavelengths other than that which we desire to receive and to which the receiver is tuned.

In the last assignment, we studied the construction and operation of one type of receiving transformer known as the auto-transformer, or tuning coil. We learned that this type of receiving transformer is conductively coupled, since

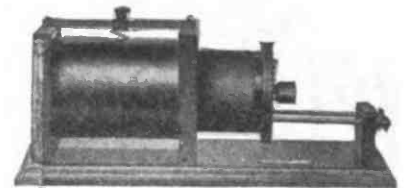

Fig. 32. Loose Coupler.

there is actual electrical connection or contact between its primary and secondary windings. The type of receiving transformer in which there is no electrical contact between the two coils or windings is called a *loose coupler*. Strictly speaking, even a two-slide tuning coil may be termed a loose coupler, since it is possible to produce loose couplings between the windings by reducing the number of turns of the inductance common to both circuits.

The method of varying the coupling between the primary and secondary of an auto-transformer, as described in the text accompanying Fig. 29, is somewhat crude, involving, as it does, a reduction in the secondary inductance for a reduction of coupling. True, the variable condenser may be used to increase the wavelength of the secondary circuit when the secondary inductance is reduced. It may happen, however, particularly in receiving the longer wavelengths, that the variable condenser may not have sufficient capacity to compensate for the reduction of the secondary inductance necessitated by a reduction in coupling.

This difficulty is obviated in the loose coupler, since, with certain minor limitations, no change in either the primary or secondary inductance is produced or required for a variation of the coupling. A loose coupler consists of two tuning coils, one—usually the secondary—being

*Continued on page 84*

**For  
Xmas**

# WORKRITE Concertolas

**\$12.00**

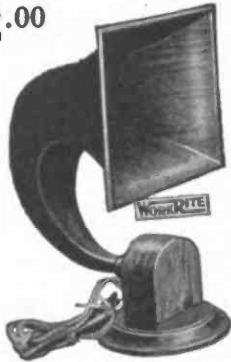

**CONCERTOLA JR.**  
A graceful, beautifully constructed instrument, harmonizing with your house furnishings.

**H**ERE they are—the loud speakers produced by the Workrite engineers—Concertola Sr. and Jr. Perfected until they are worthy of the name Workrite. Hundreds of thousands of radio fans who have used Workrite Radio Products know that “Workrite” means perfection. Workrite Concertolas accurately reproduce music or voice from the broadcasting station without the slightest distortion. On still nights they have been heard two city blocks away. The sound chamber in both of these instruments is made from our specially developed material. Why listen to music through a “tin-panny” metal horn that loses all the beautiful tones of the artists, when you can buy Workrite Concertola that will give you perfect reproduction of voice and music.



**\$24.00**

**CONCERTOLA SR.**  
Made from the finest grade mahogany with handsome rubbed finish.

EXCEPT FOR THE PHONE

**There Is Not The Slightest Metal Used In Either The Workrite Concertola Senior or Junior**

**IMPORTANT!** The best sound amplifier will not get results with an ordinary head phone. Our engineering department has developed the Workrite Concert Phone for just one purpose—to be built in the Workrite Concertola Sr. and Jr., making a combination that is unequalled. This special phone is not sold separately from the Concertola. Phones and cord are built in each instrument.

**Workrite Concertola Jr. \$12**

**Ideal Christmas Present** Here is an instrument that can be connected to any set that has a two step amplifier and the whole family can enjoy the concerts during the holidays. Order at once so you will not be disappointed.

**Workrite Concertola Sr. \$24.00**

**BEFORE BUILDING A SET WRITE FOR OUR FREE CATALOG!**

New Workrite Super Rheostat

Workrite Super Variometer

Workrite 180° Super Variocoupler

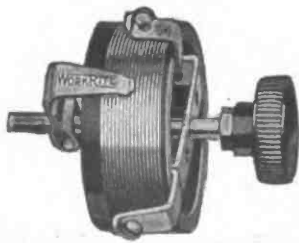

Here is a real Rheostat—something entirely new and very much needed. Can be instantly changed from 6½ ohms resistance to zero by simply pushing in the knob, or you can have fifty thousand different adjustments by turning the knob. Many engineers claim the Workrite Rheostat will double the efficiency of the set. Screws for mounting on panel furnished. The Workrite Rheostat is really remarkable in its performance and is easily worth twice the price asked. No set should be without it. Price.....\$1.50

**JOBBERs and DEALERs**  
Write or wire for discounts

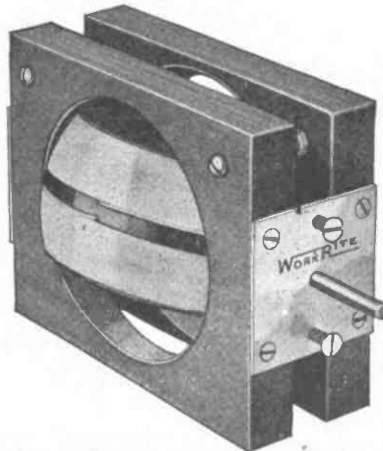

THE WORKRITE VARIOMETER is made from finest quality mahogany. All windings are perfectly made, and connections cleverly concealed. Substantially built throughout. WORKRITE VARIOMETER packed in attractive box.....\$5.25  
With Workrite E-Z-Tune Dial. 6.00

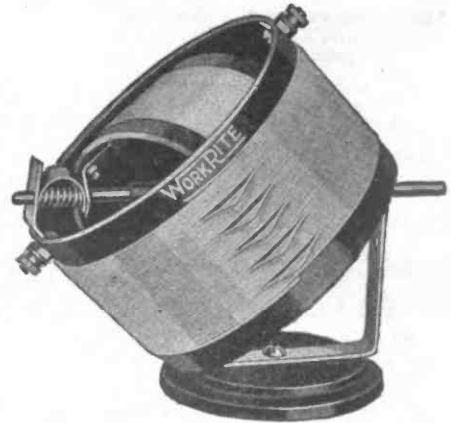

THE WORKRITE VARIOCOUPLER represents perfection in getting all dimensions and number of wire turns just right. Tunes twice as sharp as the ordinary 90-degree coupler. WORKRITE VARIOCOUPLER packed in attractive box.....\$5.00  
With Workrite E-Z-Tune Dial. 5.75

**THE WORKRITE MFG. CO.,**

**5539 Euclid Avenue,  
CLEVELAND, OHIO**

R-N. 10227

Tell them that you saw it in RADIO

# Clickerty! Clank!



Does your rheostat go—"Clickerty-clank! BANG!" whenever you make an adjustment! It would not if it were General Radio constructed. When your tube is approaching the critical point, it is necessary that the adjustment be fine and introduce no extraneous noises in your head phones.

When you construct your set, you would not mount a toaster on the panel. Then why mount a rheostat that runs hot! The radiation surface of the General Radio rheostat is sufficient to permit the rheostat to be mounted in small enclosed spaces without fear of heat damage.

The base is real bakelite—no substitutes used; the switch blade is rugged phosphor bronze and polished nickel-plated. The knob is convenient and attractive.

Made in two styles. Type 214-A for back-of-panel mounting, and Type 214-B for front-of-panel mounting or portable use. Also made in two sizes, for receiving tubes and for power tubes.

7 ohms, 1.5 amps. for receiving tubes  
2 ohms, 2.5 amps. for five-watt tubes  
PRICE, any style.....\$2.25

Similar in general dimensions and design to the rheostat is the 400-ohm potentiometer. This instrument is ideal for grid biasing.

PRICE, any style.....\$3.00

Send for Free Bulletin 911-C

## GENERAL RADIO CO.

Massachusetts Ave. and Windsor St.  
CAMBRIDGE 39, MASSACHUSETTS

Standardize on General Radio  
Equipment Throughout

Do not confuse the products of the GENERAL RADIO CO. with those of other concerns using the words "General Radio." The General Radio Co. has been manufacturing radio and scientific instruments for many years. It has no affiliation with any other company.

Continued from page 82

of the slightly smaller diameter so that it may be moved in and out of the other. See Fig. 32.

In the last assignment, we learned that the coupling between the two windings of an auto-transformer may be varied by the variation of the number of turns of inductance common to both circuits. Since the loose coupler is an inductive transformer similar to that shown in Figs. 22 and 24, there are no turns included in, or common to, both circuits. Obviously, then, some other means of varying the coupling must be employed.

The degree of coupling between the primary and secondary, whether of an auto-transformer or loose coupler, depends upon the number of turns of wire on the secondary and the strength of the

In Fig. 34 the secondary has been drawn partially out of the primary, so that only part of the secondary is threaded by the lines of force. The coupling has thus been reduced.

In Fig. 35, only a very few lines of force thread the secondary, or we may say that only a very small portion of the secondary is intersected by the lines of force. In this position, the coupling is very loose. Practically pulling the secondary 6 or 10 in. clear of the primary results in almost zero coupling between the two.

By changing the distance between the two coils, therefore, we have a simple and effective means of varying the coupling between them. By this method we accomplish an even more satisfactory variation of coupling than that which we effected by varying the number of

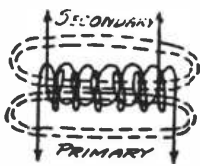

FIG 33

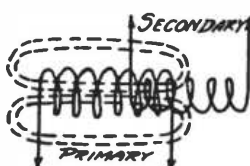

FIG 34



FIG 35

Fig. 33. Maximum Coupling. Fig. 34. Reduced Coupling. Fig. 35. Very Loose Coupling.

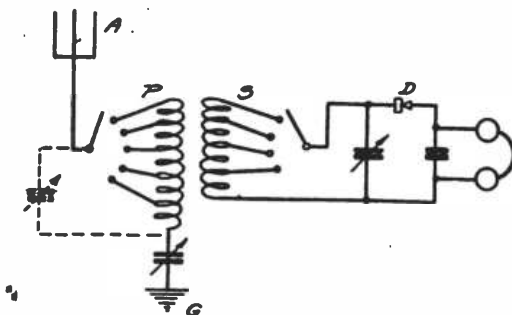

FIG 36

Fig. 36. Condenser in Primary Circuit.

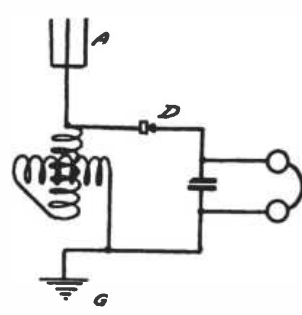

FIG 39

Fig. 39. Circuit with Variometer.

magnetic field, produced by the primary, which threads or intersects it. The strength of this magnetic field is usually spoken of as the number of lines of—magnetic—force. These lines of force are represented by the dotted lines of Figs. 22, 24 and 25.

Thus, for a given number of turns in the primary, there are two methods by which we may vary the coupling—either by reducing the number of turns in the secondary, as is done when using the auto-transformer, or by reducing the number of lines of force threading the secondary. This is the principle employed with the loose coupler.

In the loose coupler shown in Fig. 33, the secondary is shown as inserted completely within the primary. In this position all the lines of force generated by the primary thread the secondary and we say that there is maximum coupling between the two.

common turns with the two-slide tuning coil.

In the last assignment was mentioned the deleterious effect produced by the sliders short-circuiting adjacent turns of a tuning inductance. The same disadvantage obtains when sliders are used to vary the primary and secondary inductances of a loose coupler. To obviate this, it is customary, in modern practise, to substitute for the sliders a multi-point switch to which are brought taps from the inductance. If taps are taken off every ten or fifteen turns, some means must be provided to tune in between the wavelength values obtained when the switch is connected to adjacent taps. This is accomplished by connecting a variable condenser either in series or in parallel with the antenna inductance and in parallel with the secondary, as shown in Fig. 36. The variable con-

Continued on page 86

Tell them that you saw it in RADIO

**"COPPERWELD"**

THE IDEAL RADIO ANTENNA

COPPERWELD IS 50% STRONGER  
than Copper. can be strung taut, stays up, when  
other wires stretch and break, and gives  
100% electrical efficiency.

COPPER GLAD STEEL COMPANY  
BRADDOCK P. O., HANNOV, PA.

Directions for Antenna construction  
on reverse side of carton

BUY IT IN CARTONS

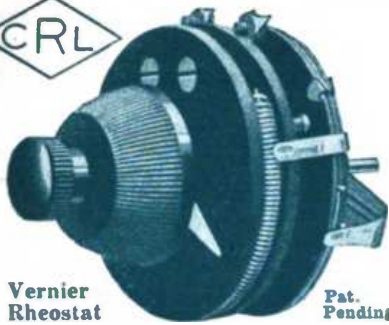

Vernier Rheostat

Pat. Pending

**IT'S A REAL JOY**

to be able to tune your set to just the right wave length.

C R L Vernier Rheostats provide for extremely accurate control of the filament current over its entire range.

You'll like the noiseless, smooth action that the C R L design insures. Each turn of the resistor is anchored permanently in its correct position.

For best results, insist on C R L Rheostats and Potentiometers of both the plain and vernier types.

**Central Radio Laboratories**

303 16th Street

Milwaukee,

Wisconsin



**"KELLY-DAYTON"**

Variable Condenser with Vernier

45 Plate .....\$5.50

25 Plate ..... 4.50

without vernier

43 Plate...\$4.00 23 Plate...\$3.50

**"The Last Word in Tuning"**

Made by

**AMERICA'S PIONEER WIRELESS EXPERT**

Write for Free copy of "Dots & Dashes"

**Dayton Radio Mfg. Co.**

1601-7 Chapel St. Dayton, Ohio



**JENKINS VERNIER RHEOSTAT**  
Indispensable for adjustment on Radio Frequency and Detector Tubes. Patent instant cut-off switch. Write for folder. Liberal discounts to dealers and jobbers.

Manufactured and Guaranteed by **UNITY MANUFACTURING CO.**  
224 N. Halsted St., Chicago, Ill. Phone Haymarket 1819

\$1.75



**Carter "TU-WAY" Radio Plugs**

take two head sets and all types cord tip terminals. Write for Bulletin on Carter "HOLD-TITE" Jacks and other products.

**CARTER RADIO CO., 209 S. State St., Chicago**

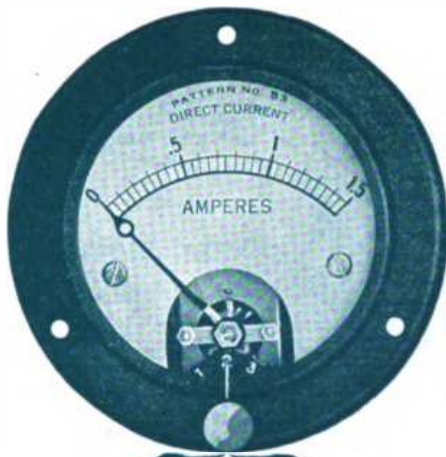

**Triplex Filament Meter**

Filament control by the use of proper instruments in receiving sets is the trend of the times. The Jewell triplex filament instrument, made as an ammeter or voltmeter, places on your panel the proper means for controlling the filaments of three tubes. It has a self-contained mechanism for switching to either tube and being of small size, can be accommodated on the most compact tube set.

**Price \$10.00**

We were the first to supply a complete line of miniature radio instruments of uniform size. Ask your dealer or write to us for complete radio circular.

**JEWELL ELECTRICAL INSTRUMENT CO.**  
1650 WALNUT ST., CHICAGO

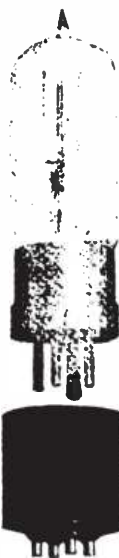

WD. ADAPTOR

**It's New!**

The illustration shows our Adaptor which will enable the use of WD-11, 1 1/2 Volt Tubes in equipment with standard sockets.

Made of an insulator with split tube contacts. Size 1 1/8 x 1 1/8. Connections all enclosed. Fool-proof, indestructible.

List price, \$1.50 each. Liberal discounts to Dealers.

**F. Jos. Lamb Company**

DETROIT

1940 Franklin St.

**Xmas Gifts FREE!**

**LEFAX RADIO HANDBOOK FREE**

with one subscription to "RADIO" for 18 months

This book sells for \$3.50. You get it free with a \$3.75 (18 months) subscription.



**RENEW YOUR EXPIRED SUBSCRIPTION OR EXTEND YOUR PRESENT SUBSCRIPTION AND GET THIS FREE LITERATURE.**

If You Do Not Want the famous LEFAX HANDBOOK we will send you SEVEN Popular Illustrated Volumes of "THE EASY COURSE IN HOME RADIO" Edited by General Geo. O. Squier, for an 18-months subscription.

Your Radio Friend will enjoy a Radio Xmas Gift from you—why not send him "Radio"—or the premium—or both?

Just write your name and address on a piece of paper and send your remittance of \$3.75 to —

**RADIO Pacific Building, San Francisco, Cal.**

Tell them that you saw it in RADIO



## Perfect Reception

Brandes *Matched Tone* headsets are the standard equipment of the receivers made by the leading radio manufacturers. The listener judges a radio receiver by what he hears. It follows that Brandes *Matched Tone* headsets must have the qualities that the radio manufacturer demands.

If your receiver is not equipped with Brandes *Matched Tone* headsets, you are not hearing the music perfectly.

Send ten cents in stamps for the "Beginner's Book of Radio." It explains radio in terms that anyone can understand.

### Distributors and District Offices:

Munsey Bldg., Washington, D. C.  
38 S. Clinton St., Chicago, Ill.  
704 Granite Bldg., Pittsburgh, Pa.  
709 Mission Street, San Francisco, Cal.  
76 Pearl St., Boston, Mass.  
802 Forsyth Bldg., Atlanta, Ga.  
1220 Nicollet Ave., Minneapolis, Minn.  
International Electric Company, Wellington, N. Z.

## C. Brandes, INC.

*Matched Tone* Headsets

237 Lafayette St., New York

Dept. R

Made in Canada by Canadian Brandes, Ltd., Toronto, and distributed by Perkins Electric, Ltd., Montreal.

MAKE THIS A RADIO CHRISTMAS

Kearny 2778

# Pacific Radio School

ARC AND SPARK SYSTEMS

Hours—10 to 12 noon  
1 to 4 P. M.  
7 to 9 P. M.

Send for  
descriptive  
circular

433 Call Bldg.,  
San Francisco, Cal.

This school is equipped with KLEINSCHMIDT Automatic Telegraph System

Continued from page 84

denser in dotted lines represents the capacity shunted across the primary when receiving wavelengths appreciably longer than the fundamental wavelength of the antenna circuit, in which case, of course, the series condenser would not be used.

Fig. 37 illustrates the tapped type of loose coupler with two sets of taps on the primary, one set covering every ten turns, and the other set connected to ten single turns. With such an arrangement as this, it is possible to tune to a single turn of primary inductance without the use of a variable condenser, a rough adjustment being made with the first switch, and a fine regulation with the second or unit turn switch. However, the arrangement shown in Fig. 36 is in more common use.

In tuning for radiophone music, or for signals from any sharply tuned transmitter—all modern transmitters are sharply tuned—the primary condenser is first set at about one quarter of its maximum capacity. The primary inductance switch is next regulated until signals are loudest. The primary condenser is then adjusted until the signal strength is at a maximum. If too much inductance had been inserted by the primary switch, the capacity would have to be reduced and vice versa.

The secondary should be pulled about three-quarters clear of the primary. The secondary switch and condenser should now be adjusted for maximum signal strength. Next, the secondary should be drawn a little farther away from the primary. This change in the coupling will necessitate a slight readjustment of the primary and secondary condensers. The secondary should now be pulled still further clear of the primary and readjustments made of both condensers. If signals are weaker at this position of the secondary, the latter should be moved back to the second position.

Loudest signals and sharpest tuning will usually be obtained with the secondary fairly well out of the primary. This is particularly true when receiving sharply-tuned transmitters. It must be remembered in tuning that for every change in the position of the secondary, or the coupling between the two coils, a slight change in the tuning adjustments of both circuits must be made. This is because a change in the degree of coupling produces a slight change in the inductance of each circuit.

### VARIOMETERS

In the last assignment and in this, we have considered the use of tuning coils and loose couplers—both of which primarily are devices for the variation of the inductance of a circuit. In addition, the loose coupler provides a means for the inductive coupling of two such variable inductances.

Continued on page 88

Tell them that you saw it in RADIO





**RADIO FREQUENCY AMPLIFICATION**

**M**U-RAD Receiving Sets are the original product of independent experiments and experience of leading radio engineers. Five years intensive development of Radio Frequency Amplification have given Mu-Rad Sets exclusive points of difference—points that are well worth your consideration. First, unequalled **sensitivity**. Distances in excess of 1000 miles have been covered by Mu-Rad Sets using a 3-inch diameter, inside loop aerial. Second, the **selectivity** of Mu-Rad Sets which permits differentiation of stations 1% off tune, and third, the **simplicity** of operation. All tuning can be done with one hand. The high selectivity is retained by the use of patent circuits and Mu-Rad R F Amplifier Transformers.

**SPECIFICATIONS**

**Cabinet:** Solid mahogany, varnished piano finish.  
**Panel:** Mirror polished black Radion.  
**Dials:** Non-warping metal—prevent body capacity effects.  
**Condenser:** 21 plate, permanent capacity.  
**Modifier:** A circuit unit, dial operated from panel, for controlling signal strength and stabilizing circuits.  
**Rheostats:** Special sector wound, smooth operation, positive contact.  
**Filament Switch:** Special positive toggle knife-blade construction.  
**Binding Posts:** Polished nickel, all in rear, plainly marked.  
**Name Plates:** Extra deep reversed etched, black with satin silver high-lights.  
**Wiring:** Tinned copper bus-wire, all interior metal white nickel finish.



**The MA-12**  
 Three stages of radio frequency amplification and detector. With 2 telephone plugs. \$128.00



**The MA-13**  
 Three stages of radio frequency amplification, detector and two stages of audio frequency amplification. With 2 telephone plugs. \$160.00

**1000 Mile Range Guaranteed**

Each MU-RAD set is sold with an attached guarantee of 1000 mile reception under average conditions using a small loop aerial.



**MU-RAD R F AMPLIFYING TRANSFORMERS**  
 200-600 Meters—Air Core

The same transformer that gives to MU-RAD Receivers their extreme R F Amplification. The skill of MU-RAD Radio engineers has been concentrated on this instrument until all the objections common to most transformers were entirely eliminated. The absence of the usual iron core increases efficiency through elimination of iron losses. No metal to produce undesirable capacity effects and eddy current loss. So very accurately are MU-RAD Transformers made that their performance varies less than half of one per cent.

- Three Types
- Type T-11 for the first stage..\$6.00
- Type T-11A for the second stage.6.50
- Type T-11B for the third stage..7.00

MU-RAD R F Amplifier Transformers as well as MU-RAD Sets can demonstrate their superiority before purchase. Ask your dealer to prove these points of difference.

*MU-RAD Apparatus Sold Everywhere, Write For Literature!*

**MU-RAD LABORATORIES, INC.**

806 FIFTH AVENUE, ASBURY PARK, N. J.



Tell them that you saw it in RADIO

## Making the most of Radio with DUBILIER Products



Screw the Dubilier Ducon into any lamp - socket, and the broadcasting station comes in strong and clear. No antenna or loop is required.

No antenna, no loop—just the Ducon in a lamp socket

Price, at your dealer, \$1.50.

### Dubilier Micadons Reduce Tube Noises

Dubilier Micadons are mica condensers which are permanent in capacity. Hence they reduce tube noises due to fluctuations in capacity and greatly improve the reception.

Dubilier Micadons are made in types to meet every radio need. The price varies from 35 cents to \$1.00 each, depending on the capacity.



Micadon type 601. Made with eyelet terminals. Connect Micadons type 601 in series and parallel and build up the desired capacity. Price 85 cents and 40 cents each, depending on capacity.



Micadon type 600. Molded case. With and without gridleak mounting. Price 75 cents and \$1 each, depending on capacity.

#### BRANCH OFFICES:

San Francisco, Cal.—709 Mission Street, Suite 701-704  
St. Louis, Mo.—Syndicate Trust Building, Suite 1409  
Washington, D. C.—Munsey Building.  
Chicago, Ill.—53 West Jackson Blvd.  
Atlanta, Ga.—302-3 Forsyth Bldg.

## DUBILIER Condenser & Radio Corp.

48-50 West 4th St., N. Y.  
Canadian Distributors:  
Canadian General Electric Company,  
Toronto, Canada

# RADIO

SUPPLIES

Mail Orders Promptly Filled  
WE PAY THE CHARGES  
If It Is

## RADIO

We Can Supply It.  
U. C. BATTERY  
and ELECTRIC CO.

2158 Univ. Ave. Berkeley, Calif.

Continued from page 86

The trend of modern design of receiving equipment is toward panel mounting. In other words the equipment either is mounted externally on a panel of insulating material, such as bakelite (a synthetic compound of phenol and resins), or is mounted within a cabinet with the controls brought through to the front of the panel. The types of variable inductances which we have considered, however, do not lend themselves readily to cabinet mounting, since the only type of control which may be easily brought through a panel for external regulation is that requiring a rotary movement for its variation. Thus, a variable condenser may be mounted within a cabinet and the shaft, attached to the rotary plates, brought through the panel so that the movable plates may be revolved from the front of the cabinet.

In order to provide for a rotary variation of inductance, and for other reasons which we need not dwell on here, the receiving variometer was evolved. In passing, it is interesting to note that the variometer was first used in transmitting sets, the German Telefunken spark transmitters of twelve years ago employing variometers in the antenna circuit.

The variometer consists of two spherically-shaped inductances, connected in series and having approximately 45 turns of wire on each inductance for reception on wavelengths from 180 to 600 meters. Fig. 38 shows a common type of unmounted variometer. The inductances are wound on some insulating material—commonly seasoned hardwood, although moulded bakelite is coming into favor.

It will be seen that one of the inductances, the stator, is stationary, and the other, the rotor, revolves within it. Since the two inductances are connected to each other in series, their respective magnetic fields oppose each other when the position of the rotor with respect to the stator is such that their windings are in opposite directions. In this position, the inductance of the variometer as a whole will be practically nil, since the resultant magnetic field of these two equal, opposing fields is zero. If a half turn, 180 degrees, is given the rotor, their windings will now be in the same direction and the current will flow in the same direction through both windings. This causes the resultant magnetic field of the variometer to be approximately twice that of either the rotor or the stator alone.

By a half turn rotation of the rotor, then, we may vary the inductance of the variometer from approximately zero to twice that of either inductance. This instrument thus furnishes a simple and convenient method for varying the inductance and hence the wavelength of

Continued on page 90

Tell them that you saw it in RADIO

## Here's A Real "Built-to-Stay" Aerial Mast

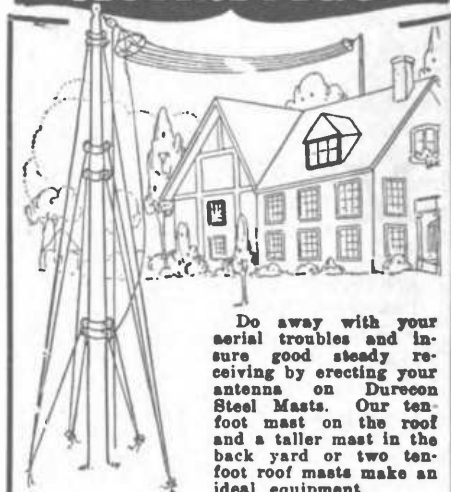

Do away with your aerial troubles and insure good steady receiving by erecting your antenna on Durecon Steel Masts. Our ten-foot mast on the roof and a taller mast in the back yard or two ten-foot roof masts make an ideal equipment.

#### Made In Section

Durecon Steel Masts are built in sections of special analysis seamless tubular steel, lighter in weight, offering less wind resistance, and much stronger than ordinary metal construction. Sectional feature simplifies erection. Two people can quickly erect a fifty-foot mast with ease.

#### Shipped Complete

Durecon Steel Masts in the following heights—10 ft., 20 ft., 25 ft., 30 ft., 35 ft., 40 ft., 45 ft., and 50 ft., can be supplied from stock complete with all fittings—guy clamps, cable clamps, guy anchors, and guy cable to support mast under any wind strain. A Durecon delivered to you is ready to put up—no additional parts to be shopped around for.

An Attractive Addition to Your Radio Outfit  
Durecon Steel Masts are better in the long run than any sort of makeshift mast you can put up—stronger and more permanent. They are professional equipment priced for the amateur's pocketbook. They add 100% to the "get-up" of your radio outfit. Write us now for illustrated circular and prices.

#### DEALERS!

Durecon Steel Masts are overcoming a big bug-bear in the building of a satisfactory receiving station. There is a big potential demand for Durecons right in your locality. Write us now on your business stationery for dealer discounts. Some good territory is still open.

Waukesha Steel Products Co.  
Dept. 31, Waukesha, Wis.



Made for All Phones

Ask Your Dealer

### THEY ARE GOOD PUT THEM ON YOUR PHONES

Slip out the metal disc and slip in the MICAPHONE. Result: Clearer, better tone, all noises eliminated. Write for circular. Discounts to dealers and jobbers.  
EADIO MICA PRODUCTS CO.  
156 E. 43d St. New York

### AEROVOX

R. F. TRANSFORMER

Free with two subscriptions to "RADIO"

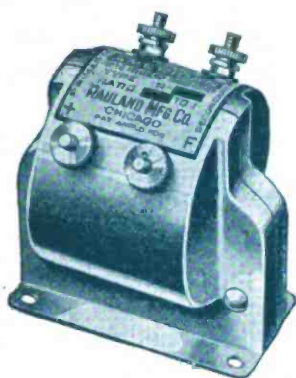

**To Strengthen Weak Signals  
To Bring-in Distant Stations  
To Get the Full Joy of Radio**

Scientific *Amplification* is the one secret of successful and satisfactory reception of Radio messages.

You will never know the full joy of Radio until you have hooked up to your set, a set of



**“All American” Amplifying Transformers**  
(Radio and Audio Frequency)

Our Radio-Frequency Transformer (type R-10) brings in signals of 150 to 550 meter wave-length, and amplifies them many-fold, clear and sharp, largely eliminating static and other disturbances.

Our Audio Frequency Transformers amplify the detected signals, so that messages that would otherwise be audible only thru head-phones come in strong enough to be enjoyed by a roomful of people thru a loud-speaker horn.

**LIST PRICES**

R-10—Radio Frequency (150-550 meters) \$4.50  
R-12—Audio Frequency (Ratio 3 to 1) 4.50

R-13—Audio Frequency (Ratio 10 to 1) \$4.75  
R-21—Audio Frequency (Ratio 5 to 1) 4.75

Send for **Bulletin No. 22.** It explains the technical and mechanical reasons for the splendid performance of “All-American” Amplifying Transformers. When you send for it, please give the

name and address of the Radio Dealer thru whom you prefer to buy. Don't let anybody sell you a Radio outfit at any price, with any other than “All American” Transformers.



**RAULAND MFG. Co.**  
35 So. Dearborn St., Chicago, Ill.



No. 55 Radio Frequency Amplifier

**Federal**

—a  
**crowning  
achievement**



No. 56 Radio Frequency Amplifier and Detector

**RADIO FREQUENCY  
AMPLIFYING APPARATUS  
INCLUDING**

- No. 55 Federal Radio Frequency Amplifier..... \$58.00  
(Two Stages Radio Frequency Amplification)
- No. 56 Federal Radio Frequency Amplifier and Detector..... 52.00  
(One Stage Radio Frequency and Detector)
- No. 57 Federal Radio Receiver—The Broadcast Receiver DeLuxe..... 98.00  
(One Stage Radio Frequency—Detector—Two Stages Audio Frequency)
- No. 58 Federal D. X. Radio Receiver—For Long Distance and Amateur Reception..... 116.00  
(One Stage Radio Frequency—Detector—Two Stages Audio Frequency)
- No. 8 Federal Audio Frequency Amplifier and Detector..... 52.00  
(One Stage Audio Frequency and Detector)
- No. 9 Federal Audio Frequency Amplifier..... 58.00  
(Two Stages Audio Frequency Amplification)

A combination of No. 55, No. 56, No. 9, constituting three stages Radio Frequency, Detector and two stages Audio Frequency, is ideal for use with loop or other restricted antenna.

Write for Bulletin No. 119-W

**Federal Telephone & Telegraph Co.**

Factory and General Offices—Buffalo, N. Y.

Western Branch—693 Mission St., San Francisco, Cal.

Tell them that you saw it in RADIO



## Quincy, Ill., Listens in on New York and San Francisco

N. G. Dowdell, 116 N. 5th St., Quincy, Ill., writes:

"With Erla radio frequency transformers in my FRL super receiver, I listen to concerts a thousand miles away every evening. The other night, I heard KUO at San Francisco as clearly as Chicago."

This is but one of the many instances where Erla radio frequency transformers are demonstrating their superiority in long distance reception.

Because of their unique ability to overcome the high capacitance effects of domestic vacuum tubes, as well as their own reduced capacitance, they produce unequalled magnification without distortion.

To make sure of a receiving set that is the last word in up-to-dateness and efficiency, write for our Bulletin No. 12, showing guaranteed hook-ups using Erla radio frequency, with full directions for installing.

Manufactured by **Electrical Research Laboratories** Dept. H, 2515 Michigan Ave., Chicago  
Coast Representative **Globe Commercial Co.** 709 Mission St., San Francisco

# ERLA

Trade-Mark Reg.



Both in results and intrinsic value, Erla radio frequency transformers have no equal. List price, \$4.00.



Erla bezels add 100% to the appearance of any receiving set. Fit 1 1/4" hole in any 1/2" to 3/4" panel. Price, 20c.



The strongest and most beautifully finished socket on the market. Nickeled shell. Radi-on base. Price, \$1.00.

**JOBBERS**—Erla products sell on sight, and stay sold, creating business in steadily increasing volume. Write for our liberal terms and discounts.

Continued from page 88  
radio receiving circuits and as such may be used in any circuit in place of a single slide tuning coil.

Fig. 39 is a duplicate of Fig. 26 with the exception that a variometer is substituted for the single slide tuner of the latter figure.

Variometers, when mounted, are fitted with a knob and graduated dial, the latter usually reading from 0 to 100, or from 0 to 180 (degrees of a circle). At the 0 position, the rotor and stator windings oppose each other so that the inductance is virtually nil. This is equivalent to setting the slider in Fig. 26 at the upper end of the tuner. As the knob and dial which carries the rotor are revolved, the rotor of the vari-



Fig. 38. Unmounted Variometer.

ometer is gradually shifted so that its field is changing from an opposing to an aiding one when turned through 180 degrees. This is equivalent to running the slider down to the lower end of the tuner of Fig. 26.

A variometer may also be used in place of the single slide tuner shown in Fig. 28, in which case it would be shunted by a variable condenser.

It will be noted that while the resistance of the tuner in Fig. 26 is increased as we tune to longer wavelengths, due to the insertion of additional turns of wire in the circuit, the resistance of the variometer is always constant, since the number of turns of wire is not changed. At short wavelengths, then, a circuit containing a variometer has a higher resistance than one employing a tuning coil.

The variometer principle, in a measure, has been applied to the loose coupler. Such a loose coupler is called a *vario-coupler*, and is shown in Fig. 40.

The primary inductance is usually tapped, leads being taken to a panel on which a multi-point switch is mounted, and the secondary, which is spherically shaped like the rotor and stator of a variometer, is generally untapped. Unlike the variometer, and similar to the loose coupler, the primary and secondary of a vario-coupler are not connected together, the magnetic lines of force of

Continued on page 92



(Actual Size)

## GREWOL the DETECTOR

*With a National Reputation*

ENTIRELY different—ininitely superior. Makes the crystal set more convenient, efficient and attractive. Insist on GREWOL—nothing as good because there's nothing like it.

*Dealers: There's Profit in this Big Value Item*

## RANDEL WIRELESS CO.

Sole United States Distributors  
9 CENTRAL AVENUE NEWARK, N. J.

Lasting Adjustment Glass Enclosed Always Set and Ready

# \$2

Tell them that you saw it in RADIO

# DICTOGRAPH Radio HEADSET

## Was \$12.00 NOW



### WHY THIS SENSATIONAL REDUCTION IN PRICE?

A sweeping cut of \$4.00 in the price of the Dictograph Radio Headset! The tremendous endorsement of radio enthusiasts has made possible this sensational reduction. To meet the demand, production has been planned on a new, gigantic scale. Great manufacturing economies establish the new price—only \$8.00 complete with 5 ft. cord.

A wonderful bargain! And above all, a wonderful headset—the world's standard of supreme quality for super-sensitive and accurate sound-transmission.

The same quality, the same guarantee, the same supreme Dictograph headset in every respect but the price. Type R-1, 3,000 ohms, for all types of receiving sets.

### DICTOGRAPH Radio LOUD SPEAKER



#### The Perfect Loud Speaker for the Home

Public demand has made possible the Dictograph Loud Speaker at the low price of only \$20.00, complete with 5-ft. flexible cord. A handsome instrument that reproduces every sound in crystal-clear, natural tones, full volume, and free from distortion or noise. Ask for demonstration at reliable radio dealers. Get world-famous DICTOGRAPH quality and still save money.

Dealers: Order through your jobber or write direct for names of authorized distributors.

### DICTOGRAPH PRODUCTS CORPORATION

220 West 42d Street (Branches in all principal cities) New York, N. Y.

#### THE STANDARD OF THE WORLD

Note: Plans are now under way for the production of the new 4,000 ohms Dictograph SUPER-TONE Headset, the most perfect radio headset that can be made. For the most delicate work, the most exacting requirements. A new standard of super-sensitivity! List Price, \$12.00.

## Make Your Christmas Money Count!



**ACE BALANCED VERNIER CONDENSER**

Use it to replace the weak parts of your present receiving set or to build up the "De Luxe" set you have promised yourself. The ACE balanced vernier condenser or ACE panel lever switch as illustrated, are suggestions; our general catalog contains many attractive new parts. Mailed to your address for ten cents.

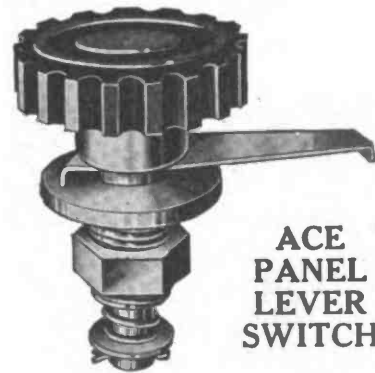

**ACE PANEL LEVER SWITCH**

Dept. PRN

**THE PRECISION EQUIPMENT CO.**

2437 Gilbert Ave.

Cincinnati, Ohio

Tell them that you saw it in RADIO

# RADIO RHEOSTATS OF REPUTATION

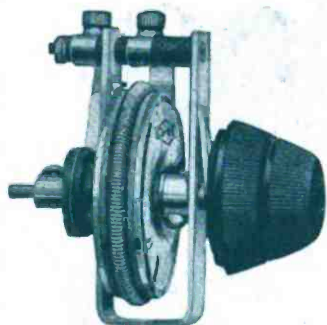

C-H Radio Rheostats are built in two styles for detector and amplifier tube control. Type 11601-H1 with vernier adjustment is recommended for detector control because of the critical characteristics of the tubes used for this purpose. Type 11601-H2 is furnished without vernier. Both rheostats have a range of four ohms with one ampere current capacity.

Type 11601-H1 with vernier ..... \$1.50

Type 11601-H2 without vernier .. \$1.00

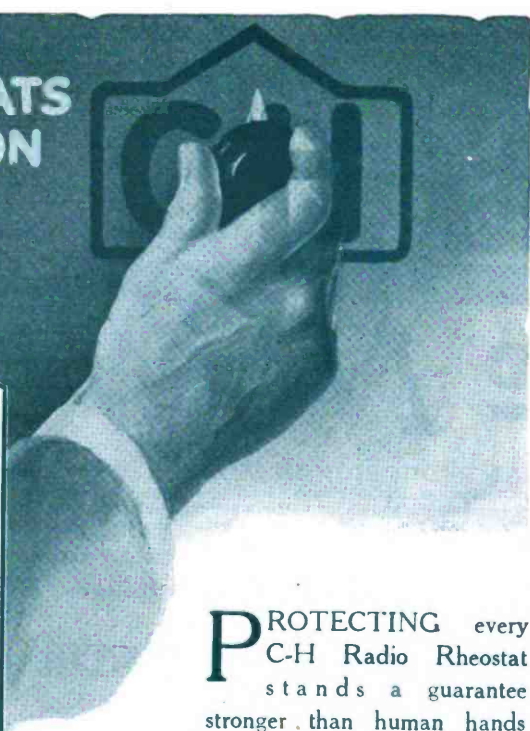

**P**ROTECTING every C-H Radio Rheostat stands a guarantee stronger than human hands can write. The decades of persistent and successful development of rheostatic control by the engineers of CUTLER-HAMMER have inspired a faith in their trade-mark that is far too worthy to forfeit.

Engineers the world over accept this mark as unfailing assurance of electrical and mechanical perfection—the signature of approval of the master rheostat builders. It is a protection you should demand in the purchase of your radio rheostat—a device in which precision and reliability are essential.

THE CUTLER-HAMMER MFG. CO  
Rheostatic Control Specialists  
Milwaukee, Wisconsin

## CH RADIO RHEOSTATS

"BUILT BY RHEOSTAT BUILDERS"



### Na-ald

Small Space  
V. T. Socket  
35c. each 3 for \$1.00

Moulded genuine condensite. Requires but small space for mounting. Readily accessible binding posts. No excess metal to interfere with efficiency. Unaffected by heat of bulbs or soldering iron. Phosphor bronze contacts. Nickel plated brass binding screws. Slash cut slot. Price possible because of large production.

Special proposition for dealers and jobbers.

**Alden-Napier Co.**  
52 Willow St. Springfield, Mass.  
Dept. H

### GET INTO RADIO

Earn big money as a Radio Expert. Thousands of attractive positions open now. Walter Van Nostrand, a graduate, earning \$3,000 a year as Radio Inspector. America's first and largest Radio School qualifies for 1st Class Gov't License in spare time at home. Four RADIO INSTRUMENTS loaned free give actual Radio practice. Position guaranteed 60 days after graduation and securing Commercial License or money back. Write for free book about Radio. Mention name, age, address.

NATIONAL RADIO INSTITUTE  
Dept. M-10. Washington, D. C.

Get two subscriptions to "RADIO" for one year and we will send you a \$5 Amplifying Transformer free!

Continued from page 90

the primary inducing a potential across the secondary or rotor.

When the secondary is turned so that its winding is parallel to that of the primary, as in Fig. 41, a maximum number of lines of force thread the secondary and maximum coupling is obtained.

When the rotor is turned so that its winding is at right angles to that of the primary, as in Fig. 42, the lines of force no longer thread the secondary parallel to its axes and hence produce no effect upon it. In this position, the inductive coupling between the primary and the secondary is virtually zero. By a right angle or 90 degree turn of the rotor, then, the coupling may be decreased from maximum to minimum.

The vario-coupler thus serves as a very convenient form of loose coupler, particularly for cabinet mounting. It is connected as shown in Fig. 43. This figure is identical with Fig. 36 except that the rotor or secondary is not tapped. In Fig. 43, the rotor is designed to have the proper number of turns for

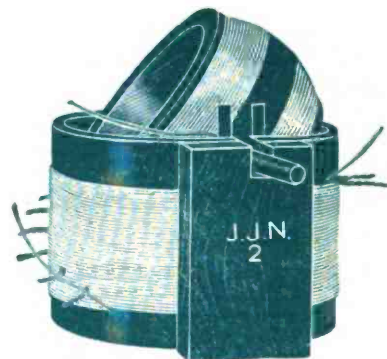

Fig. 40. Vario-Coupler.

radiophone reception so that the variable condenser alone may be used to tune the secondary circuit to the resonant wavelength.

The operations of varying the primary and secondary circuit wavelengths and the coupling are exactly as described for tuning the loose coupler, except that a rotary instead of a horizontal motion is given the secondary for variation of coupling.

#### HONEYCOMB COILS

In 1919 the De Forest Radio Telephone & Telegraph Company brought out a new type of tuning inductance known as the *honeycomb coil*. This is shown in Fig. 44.

When using tuning coils or tapped inductances on very short wavelengths, the amount of unused inductance would seem to play no part in the electrical action of the circuits in which they are connected. Actually, however, the usual type of inductance, particularly if it is wound in layers, is said to possess *distributed capacity*. This distributed capacity is due to the electrostatic attraction exerted between adjacent turns

Continued on page 94

Tell them that you saw it in RADIO



# CLARK Vario-Antenna

## The Remarkable Tuner

A scientific device, the result of thirty-two years' experience.

Eliminates the Aerial, Easily Tuned to All Conditions.

Not to be confused with any electric light socket device that cannot be tuned.

The Vario-Antenna makes it possible to operate many Radio Receiving Sets at the same time in the home, apartments, hotel and office building, by simply attaching to any electric light socket, and in comes that mysterious energy that brings with it the News of the World, Music, Laughter, Current Events, Knowledge and the satisfaction of knowing that your home contains the last word in scientific equipment for complete enjoyment.

### A Wonderful Xmas Gift

Buy it of your Dealer or send us \$10.00 for One by return mail, [postage paid, cord and plug will be included.

A Variable  
Light Socket  
TUNER

Manufactured by  
**Clark Radio Mfg. Corporation**  
3045 Hopkins St. Oakland, Calif.



**American Electric**  
HIGH EFFICIENCY  
**HEAD SETS**

**Army and Navy Type:**  
2500 ohm, per pair.....\$10.00  
3200 ohm, per pair.....\$12.00

**Swedish-American Type:**  
2200 ohm, per pair.....\$8.00

**Victor Type:**  
Double pole, single coil, per pair..\$6.00

**American Electric**  
COMPANY  
CHICAGO, U. S. A.  
For 30 Years Makers of Good Telephones

**RADIO "A & B" STORAGE Batteries CHARGED at Home For Few Cents With "PATENTED FULL WAVE" Automatic Magnetic 100-130 Volt 60 Cycle A. C.**

## F-F RADIO RECTIFIER

Eventually You Will Buy An F-F RECTIFIER. Why Not Now?  
THE SOONER YOU BUY IT; THE MORE YOU SAVE

It CHARGES All 16 Volt RADIO "A" & AUTO Batteries; & All RADIO "B" & LOUD SPEAKER Storage Batteries Up To 120 Volts, In Series Inductively At Home Overnight. Disconnecting & Multiple Connections Unnecessary. Charging Circuit Separate. Nothing Like It Made. No Chance For Grounds Or Short Circuits. No Skill Required. AMMETER eliminates Guess Work. It Costs You Less To Buy An F-F RECTIFIER than To Be Without One. You PAY for ONE whether You Buy One Or Not, for It Costs An Average Of \$2. for Charging & Rentals Every Time An Auto Battery Is Charged By Others, but Only A Few Cents When You Charge Your Own From A Lamp Socket Within An F-F Battery Boosting RECTIFIER. If You Have Never Known The Delightful Feeling Of Having Your Storage Batteries Always Fully Charged For RADIO & AUTO You Will Experience A New Thrill When You Have A RECTIFIER of Your Own Which Gives You A Fully Charged Battery Overnight At A Cost Of a Few Cents & A Joyful Feeling of Things Well Done. Those Who Own Them Feel Their F-F RECTIFIER is Their Faithful Friend. It Charges Automatically & Being Clean Can Be Placed Anywhere. Nothing To Slop Over Be Filled Burn Out Need Attention Or Cause Trouble. Both Waves Of Current Are Rectified Thru Infusible Carbon Rectifying Brushes, Maintaining CONSTANT EFFICIENCY uninterruptedly While Its FULL WAVE Design Delivers The RAPID TAPER CHARGE recommended By All Storage Battery Manufacturers.

They Also Charge AUTO Batteries Overnight Right In Your AUTO

**\$20**

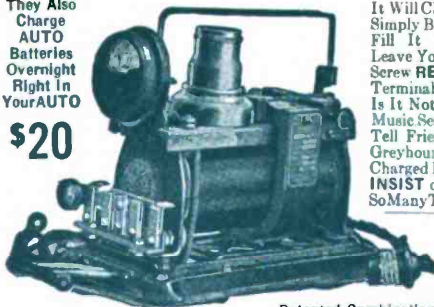

Patented Combination.

**CHARGES AUTO & RADIO BATTERIES.** All TYPES But "B" CHARGE AUTO BATTERIES.

The Larger TYPES are Recommended For Heavy Batteries, or Where Time Is Limited. SHIPPING WEIGHTS Complete With AMMETER & BATTERY CLIPS 11 to 15 lbs. Purchase From Your Dealer, Or Mail Check For Prompt Express Shipment. If via PARCEL POST have remittance include Postage & Insurance Charges, or WRITE us to Ship TYPE desired C. O. D. Other F-F Battery Boosters Charge Batteries from Farm Lighting Plants & D. C. Circuits & for GROUP CHARGING Economy. Use Our 8 Ampere 12 Battery Capacity Automatic Full Wave F-F ROTARY RECTIFIER Described in ROTARY Bulletin 33-A. ORDER Now, or WRITE Immediately for FREE Descriptive RADIO & AUTO BOOSTER & ROTARY Bulletins 33-A & 33

**FRANCE MFG. CO.** General OFFICES & WORKS: CLEVELAND, OHIO, U. S. A. Canadian Rep.: Battery Service & Sales Co., Hamilton, Ontario, Canada.

Tell them that you saw it in RADIO

# Real Radio Values

Order Direct and Save Money

Look Over These Holiday Specials:

	Regular Price	Our Price
Unit Audion Control Panels (Detector)....	\$ 6.50	\$ 5.00
Unit Audion Control Panels (Amplifier) ..	13.50	10.00
Glass Enclosed Crystal Detectors-less crystal.	2.00	1.50
23 plate Universal Condenser, bakelite ends, .0005 Mfd. ....	4.00	2.50
43 plate Universal Condenser, bakelite ends, .001 Mfd. ....	5.00	3.00
3 plate Universal Ver-nier Condenser, .000246 Mfd. ....	1.50	.75
Keystone Variometers		
150-580 meters .....	5.00	4.00
6 V. 60-80 Amp. Storage Batteries .....	16.00	12.00
Open Circuit Jack.....	.60	.33
Single Circuit Jack.....	.75	.40
Double Circuit Jack...	.90	.48
Double Circuit Jack Fi-lament Control .....	1.00	.55
Single Circuit Jack Fi-lament Control .....	1.20	.63
Saturn Automatic Grip Telephone Plug .....	1.50	.98
Ajax Socket Rheostat...	2.00	1.40
Dictograph Headsets		
3,000 ohms .....	8.00	8.00
Dictograph Loud-speakers .....	20.00	20.00
Bestone Filament Rheo-stat .....	1.00	.60
Bestone Variocoupler, 3-inch dial, 150-600 meters .....	8.00	5.75
Bestone Variocoupler, 3-inch dial, 150-580 meters .....	7.00	4.75
Bestone Socket, metal, shell, bakelite base...	1.00	.75
Federal Jr. Receiving sets, Dictograph Headset .....	25.00	15.00

Everything sent F. O. B. Jersey City the same day we receive your order. Send Money by Registered Mail, Post Office or Express Money Order.

All Goods Guaranteed the Best There Is.

## HOLMES RADIO PRODUCTS

999-A Bergen Avenue  
Jersey City, N. J.

Continued from page 92

or turns in close proximity to each other. The unused portion of the inductance is called the *dead-end*, and its distributed capacity is represented by the condenser in dotted lines in Fig. 45.

This distributed capacity in the dead-end thus forms a small oscillating circuit. If this parasitic circuit should happen to be in resonance with the incoming wave, as it often is, it will extract a large amount of energy from the primary and secondary circuits with a consequent decrease in signal strength.

It is highly desirable, therefore, to use only as much inductance as is necessary for proper tuning and thus to eliminate the deleterious dead-end effect.

The honeycomb coil is an inductance in which the distributed capacity, due to the peculiar form of crisscross wind-

ing, is reduced to a minimum. The coils are made in various sizes for the reception of wavelengths from 150 to 25,000 meters, and are designated by numbers to indicate the number of turns with which they are wound. Since honeycomb coils generally are not tapped they must always be used in connection with variable condensers which are connected in parallel across the secondary and in series or parallel with the primary, depending on whether long or short waves are to be received.

In combination with a primary variable condenser of 0.0015 m. f. maximum capacity and a secondary condenser of 0.001 m. f. maximum capacity, the following honeycomb coils are recommended by the De Forest Company for the usual wavelength ranges:

Type of Service	Wavelength Range	Primary Coil	Secondary Coil	Condenser (Primary)
Gen. Amateur	150-355	D.L.-50	D.L.-25	Series
Spec. Amateur and Radiophones	305-710	D.L.-75	D.L.-50	"
Commercial	460-1050	D.L.-150	D.L.-100	"
Navy Calling	835-1950	D.L.-250	D.L.-150	"
Navy Time	1760-4000	D.L.-500	D.L.-250	"
Navy Arc, Foreign and Press	3950-8450	D.L.-1000	D.L.-500	"
	6000-12500	D.L.-1500	D.L.-1000	"
	12000-20000	D.L.-1000	D.L.-1500	Shunt
	16000-25000	D.L.-1500	D.L.-1500	"

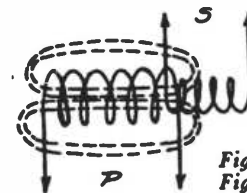

FIG 41.

Fig. 41. Secondary Parallel to Primary.

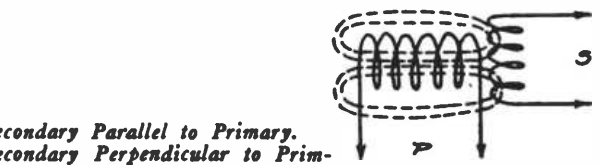

FIG 42

Fig. 42. Secondary Perpendicular to Primary.

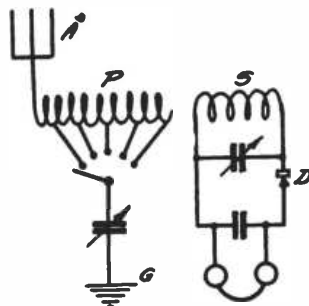

FIG. 43.

Fig. 43. Vario-Coupler Hook-up.

Fig. 45. Distributed Capacity from Dead-end.

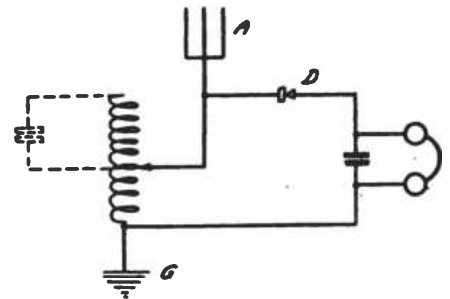

FIG 45

Honeycomb coils are used in place of the primary and secondary inductances of loose couplers. They are plugged into suitable mountings so that the distance between them — coupling — may easily be changed. When the primary and secondary honeycombs are parallel, with concentric axes, the coupling is at a maximum. When they are at right angles to each other, the coupling is practically zero. All tuning with honeycomb coils is done with primary and secondary condensers.

Because of their low resistance per unit of inductance and their very low distributed capacity, honeycomb coils are highly efficient and widely used.



Fig. 44. Honeycomb Coil.

Tell them that you saw it in RADIO





# This Panel Will Improve Your Set

## CONDENSITE CELORON

The best panel made is none too good for your set. Dependable insulation is vital because it has a direct bearing upon the clearness and sensitivity of both transmission and reception.

Every thinking radio enthusiast certainly wants the highest type panel he can obtain and the surest way to get it is to insist upon Condensite Celoron.

This strong, handsome, jet-black material is not merely an insulating material—it is a radio insulation made to meet high voltages at radio frequencies. That is why it will give you greater resistivity and a higher dielectric strength than you will ever need.

Make your next panel of Condensite Celoron. It machines readily, engraves with clean cut characters and takes a beautiful polish or a rich dull mat surface.

### AN OPPORTUNITY FOR RADIO DEALERS

Condensite Celoron Radio Panels and Parts offer a clean cut opportunity to the dealer who is keen on building business on a quality basis. Write us today. Let us send you the facts. You'll be interested.

### DIAMOND STATE FIBRE COMPANY

Bridgeport (near Philadelphia), Penna.  
Offices in Principal Cities

Branch Factory and Warehouse, Chicago  
In Canada: Diamond State Fibre Co. Ltd., Toronto

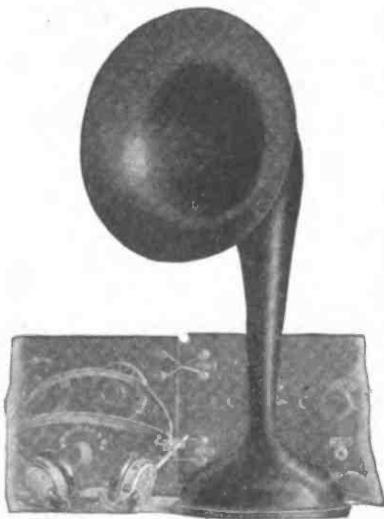

## Quality First

The Roller-Smith loud speaker comprises two special receivers built permanently into a heavy cast aluminum horn. By matching the receivers as a pair and the pair to the horn we attain the quality of reproduction which characterizes a fine

phone, combined with volume sufficient for any average room.

You will be surprised to hear the difference between it and the raucous shouter type or it and the fish horn squawker.

No batteries required.  
Handsome black crystalline enamel finish.  
Price, but eighteen dollars.

Send for Bulletin No. A1-20

**ROLLER-SMITH COMPANY**  
Electrical Instruments, Meters and Circuit Breakers

MAIN OFFICE  
20 Park Place, New York

WORKS  
Bethlehem, Penna.

Offices in Principal Cities in U. S. and Canada

## YOU CAN GET Murdock Receivers



From your dealer. Why bother with any other kind?

2000 ohm No. 56 double sets    3000 ohm No. 56 double sets

**\$5.00**

**\$5.50**

Send for free catalogue

Wm. J. Murdock Co. carries a complete stock in the warehouses of their Pacific Coast Agents,

### KEELER, WHITE CO.

509 Mission St., San Francisco  
211 South San Pedro St., Los Angeles

Tell them that you saw it in RADIO

**CALLS HEARD**

*Continued from page 44*

By 9BJI, 3935 W. 30th Ave., Denver, Colo.  
 C. W.: 4eb, 4fv, 4jy, 5aj, 5uam, 5aar, 5aat, 5acf, (5aec), 5ba, 5de, 5di, 5bn, 5eg, 5ek, 5ef, 5fa, 5fv, 5hk, (5im), 5ix, 5jb, 5jl, 5kb, 5my, 5nk, 5na, 5uv, 5kp, 5pb, 5pd, (5px), (5qi), 5rh, (5sf), 5sg, 5sm, 5sk, 5ar, 5tc, (5tj), 5tp, 5tr, 5va, 5vm, 5vo, 5xa, (5xd), 5xk, 5xv, 5xy, (5za), 5zv, 5zag, 5zp, (6aag), 6abx, (6ada), (6ajh), (6ak), 6alu, (6aun), (6apw), (6aqw), (6arl), (6atg), 6anu, 6avd, 6avr, 6atq, 6bbc, (6bcr), 6bjc, 6bqc, 6bqg, 6bqz, 6bum, (6bun), 6cu, 6cc, (6ea), (6ec), 6en, 6gf, (6iv), 6lh, 6pi, 6xp, 6zaf, (6zh), 6zr, 6zz, 7bk, 7lm, (7lu), (7ot), 7pr, 7zo, 7zu, (7zv), 8ahv, 8amun, 8apy, 8asv, 8axb, 8bef, 8bfm, 8bke, 8bnj, 8bo, 8hxf, 8fc, 8gxx, 8cjl, 8emq, 8ib, 8iq, 8pd, 8qk, 8sp, 8uk, 8yd, 8zz, 9aar, (9aeq), 9afk, 9afn, 9ahh, 9ain, 9aiy, 9ajh, 9ajp, 9ami, 9apw, 9amq, 9anq, (9aog), 9aom, 9arr, (9arz), (9atc), 9aua, 9aul, 9avn, 9avz, 9awu, 9awp, 9awa, 9axu, 9ayh, 9ays, (9bcf), 9bds, 9bed, 9bek, 9bey, 9bid, (9bie), 9bik, 9biz, (9bjv), 9blt, 9bno, 9bri, 9hsz, 9btt, 9lul, 9vbl, 9bvy, 9bxb, 9bxy, 9bzi, 9bzz, (9cca), (9ccc), 9cfl, 9cfy, 9cgl, 9chn, 9civ, (9ckm), (9cna), 9coa, 9ctr, 9cwc, 9cyp, 9dbl, 9der, 9dck, 9ddy, 9dge, 9dga, (9dky), 9dpl, 9dqe, 9dqj, (9dr), (9dsm), 9dsw, 9dtj, 9dwk, 9dxd, 9dy, 9ew, 9fm, 9gk, 9ii, 9iy, 9jk, 9nu, 9pw, (9pi), 9uu, (9ve), 9yaj, 9yak, (9zan). Can.—4bv.

By 6BIO, Oalistoga, Calif.  
 C. W.: 5hf, 5za, (6bdw), 6brf, 6bum, 6aqw, 6cp, (6bpz), (6blu), (6bqc), 6atq, (6beg), 6akw, 6brk, (6bjq), (6bqg), (6bgd), (6ake), (6ku), (6abx), (6bed), (6rd), (6aol), 7lu, (7tq), (7bj), 7aiu, (7th), (7ny), 7aeu, (7mf), 8hx, 8bk, 9cc, 9cf, 9btx, 9aos, 9de, 9aab, 9bjj, 9amb, 9zaf.  
 Spark: 6bop, 6btz, 6od, 6bcv, 6ff, (6aau), (6cc), (6tc), (7kj), (7my), (7vo), 7rc, 7tw, (7ge), (4oj), 7ve.  
 By 6BQV, 3101 S. Grand Ave., Los Angeles, Cal.  
 C. W.: 4gl, 5di, 5du, 5za, 5zb, 6ak, 6bf, 6cc, 6cn, 6cp, 6fh, 6fm, 6gr, 6gx, 6gy, 6ku, 6nx, 6oo, 6rd, 6tw, 6zb, 6zf, 6zu, 6aat, 6abx, 6ada, 6ach, 6agp, 6ahp, 6aio, 6ait, 6ajh, 6aqw, 6aol, 6asj, 6awt, 6bcd, 6bcj, 6bcr, 6bjj, 6bmd, 6bnv, 6bod, 6bqf, 6bsa, 7dp, 7lu, 7na, 7tq, 7zo, 8aio, 9bjj, 9hxt-graf, 9dug, 9zaf.  
 Spark: 6ex, 6gt, 6icl, 6vx, 6acr, 6ajh, 6aqu, 6bju.  
 By 6BSU, R. D. No. 2, San Gabriel, Calif.  
 All C. W.: 5un, 5acf, 5xd, 5za, 6nx, 6ajh, 6amk, 6atq, 6awt, 6bcj, 6bdw, 6bun, 6xad, 6zf, 6zx, 6zz, 6zac, 7lu, 7mf, 7oe, 7eq, 7asu, 9amb, 9apl, 9awm, 9bjj, 9dtm, 9cjj, 9zaf.  
 Fone: 5za, 6bum, klp, klx, kob, kvq, kzm, kzn, kdpt, kdyl, kfad, kfaf, wgh. 6BSU will have a 50 watt tube set up in January.  
*Continued on page 110*

**Just What You Want**



**W**HETHER you require two binding posts, a simple crystal set, or one of the standard tube sets with amplifier and loud speaker, you may obtain it *at the right price* at any radio shop displaying the Sorsinc Sign. There is a skilled radio man on hand to advise you, too.

*"It Pays to Buy at the Sorsinc Store"*  
 Mr. Dealer:—If you are a progressive merchant you may display the Sorsinc sign. Let us tell you how.  
**SHIP OWNERS RADIO SERVICE, Inc.**  
 80 Washington St., New York  
 Wholesale Distributors  
 Sorsinc Branches:  
 Boston, 46 Cornhill St.; San Francisco, 591 Mission St.; Baltimore, 11 N. Eutaw St.; Chicago, 538 So. Dearborn St.; New Orleans, 740 Union St.; Seattle, 67 Columbia St.



**\$5.00**      **\$7.50**

For perfect reception there is no phone like the "Royal-fone" King of All at either \$5.00 or \$7.50. Either phone will make an appreciative Christmas gift, something that anyone will cherish for a long time.

A "Royalfone" is a satisfied gift because it is guaranteed.

We will take care of you if there is no dealer in your vicinity.

**ROYAL ELECTRICAL LABORATORIES**  
 207 Market St. Newark, N. J.

*Royalfone*

**PLAY SAFE!**

**Insist on Getting "UNITED" PRODUCTS**

Follow the example of the Radio-wise experts who buy each part with an exact knowledge of its true value.



Pat. Appd. For

**United Transformers**

amplify weak sounds; bring in distant stations with clear, pleasing distinctness. A beautiful piece of workmanship with sturdy steel shell. Furnished in black enamel with buffed nickel strip....\$4.50



**United Variable Condensers**

Correct in design, high grade in workmanship. Plates are held positively, so that short-circuiting is practically impossible.

**List Prices**

43 plate ....\$4.50    11 plate ....\$3.50  
 23 plate .... 4.00    5 plate .... 2.75  
 3 plate ..... 2.25  
 without dial or knob.  
 With Vernier Attachment, Dial and Knob.  
 46 plate .....\$6.50  
 26 plate ..... 5.50  
 Only Vernier with stop.

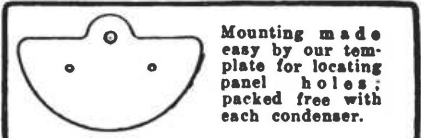

Mounting made easy by our template for locating panel holes; packed free with each condenser.

United Transformers and Condensers have been adopted as standard equipment by leading makers of radio receiving sets. Their judgment is a safe guide for you.  
 Tell your dealer you want "United or nothing." Circular Free.

**UNITED MFG. & DISTRIBUTING CO.**  
 536 Lake Shore Drive  
 Chicago

**PARADEX UNITS**

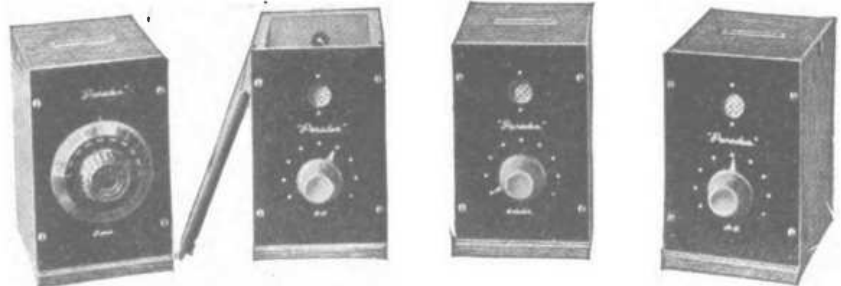

*Write for full descriptive bulletin*  
 Tuner (Pats. Apld. for).....\$20.00    Audio Freq. Amp. ....\$18.00  
 Detector ..... 10.00    Radio Freq. Amp. .... 20.00

Manufactured by  
**PACIFIC RADIO EXCHANGE**  
 439 CALL BUILDING      SAN FRANCISCO, CAL.

Tell them that you saw it in RADIO

A new

# EVEREADY "B" BATTERY



No. 767

Made up of thirty large cells arranged in five rows of six cells each, gives 45 volts and is equipped with Fahnestock Spring Clips allowing the following voltages: 16½, 18, 19½, 21, 22½ and 45 volts. This is a remarkably high quality, long life battery. Dimensions: Length, 8¾"; width, 6¾"; height, 3¾" over all. Weight 9 lbs. Price \$5.50.

Two important characteristics are necessary for a satisfactory "B" battery; first, the battery must be designed for long life; second, the operation must be noiseless. The Eveready "B" battery meets these exacting requirements.

## EVEREADY

Eveready "A" radio batteries are carried in stock by the best radio dealers in three different types—60, 80, and 100 ampere hour capacity. These Eveready "A" batteries have a larger capacity and give longer service and require less frequent recharge than most other batteries of this type.

Made on the Pacific Coast by the world's largest battery manufacturers.

## NATIONAL CARBON CO., INC.

599 Eighth St.,  
San Francisco, Cal.

419 East 2nd St.,  
Los Angeles, Cal.

# Eliminate the Storage Batteries with

"SUNECO"

ADAPTER

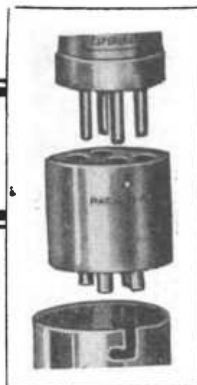

**Direction:**  
Insert tube in "Suneco" Adapter, then insert Adapter in any socket. By use of the "Suneco" Adapter, you have minimum induction effects, and minimum dielectric loss. No solder contacts to corrode.

The "Suneco" Adapter enables you to use the famous Aeriotron WD-11 dry cell vacuum tube in any radio set. Eliminating all necessity for storage batteries and the changing of wiring.

**Saves Time Price \$1.50 each Saves Money**

If your dealer cannot supply you, send money order or cash to Dept. R. Guaranteed by the N. Y. Tribune Institute.

**SUN EQUIPMENT COMPANY**  
67 Exchange Place New York

## CITIZENS

# RADIO CALL BOOK



Complete Radio Directory

Contains  
United States Amateurs  
Special Amateurs  
Experimentals and Colleges  
Canadian Amateur Stations  
Canadian Experimentals and Colleges  
Naval Stations  
Telephone Broadcasting Stations  
Federal Marine Broadcasting Schedules  
U. S. and World Time Schedules  
World Press Schedules  
World High Power Transatlantic Stations

RADIO DISTRICT HEADQUARTERS  
December - June, Annually - Year  
Price 50 Cents  
"It's Pay Now"

## CITIZENS RADIO CALL BOOK

**FIFTY CENTS  
WHY PAY MORE**

Contains all changes of address, Re-assigned Calls, Cancelled Calls—right up to date of issue—way ahead of any other Call Book at any price. Complete up to date Canadian list. Buy one, look it over, if it isn't the best you have ever seen, write us, money cheerfully refunded, at your dealer or direct from us. Postpaid.

**Citizens Radio Service  
Bureau**

416 S. Dearborn Street, Chicago

Dealers, write for  
Guaranteed Sales Plan

# RADIO SUPPLIES

Mail Orders Promptly Filled

WE PAY THE CHARGES

If It Is

## RADIO

We Can Supply It.

U. C. BATTERY  
and ELECTRIC CO.

2158 Univ. Ave.

Berkeley, Calif.

# for Xmas

Send a subscription to "RADIO" for one year. Nothing will be more appreciated. We will mail a beautiful Xmas card to your friend, telling him of your gift.

"RADIO" — San Francisco

Tell them that you saw it in RADIO

# TRADE **ESCO** MARK

QUALITY ALWAYS HAS BEEN AND ALWAYS WILL BE, THE WORLD'S SAFEST INVESTMENT

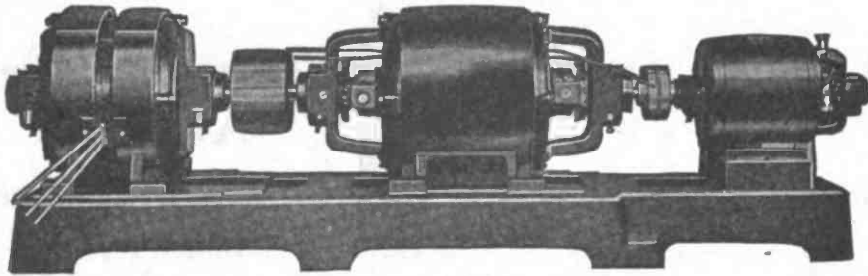

## ESCO

High Voltage Motor-Generators Stand Pre-eminent

Used by leading educational institutions, U. S. Army and Navy academies, research laboratories, newspapers, department stores and broadcasting stations.

Bulletin 237 lists over 200 combinations  
Special apparatus developed for special requirements  
Motors, Dynamotors, Generators, Motor-Generators

Sold by principal dealers everywhere

**Electric Specialty  
Company**

211 South Street  
STAMFORD, CONN., U.S.A.

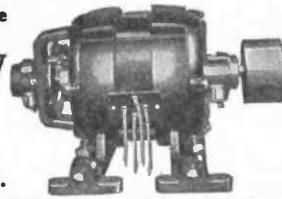
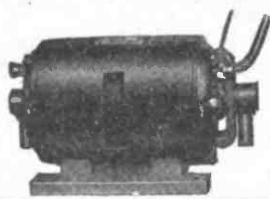

## RADIO BROADCASTING IN GREAT BRITAIN

*Continued from page 21*

traffic. But the largest manufacturers of radio apparatus have co-operated with the British government officials in working out plans for the proper control of broadcasting.

"The broadcasting stations will be operated on strictly regulated wavelengths and other set rules, which will be published for the guidance of radio receiver owners. Every radio set owner will be required to pay an annual tax, also, and there will doubtless be special restrictions applying in times of national emergency.

"One thing that British manufacturers have had to do that was not necessary in America, is to study out closely the cost of receiving sets. The average Britisher can afford to spend very much less than the American in purchasing apparatus of the nature of a luxury. But even with that drawback that British manufacturers see a great field ahead for radio."

Mr. Fleming, in addition to representing the Institute of Electrical Engineers of England at the Niagara Falls convention, is making a survey of radio developments in America. His survey may have considerable bearing on the regulations drawn up for government control of broadcasting in England. His technical career is interesting. After receiving his training at the Finsbury Technical College, he spent the following year at the London Electric Supply Corporation at Deptford, and after a short period with Messrs. Elliott Brothers, Instrument Makers, he crossed the Atlantic and joined the Westinghouse Electric & Manufacturing Company at East Pittsburg. Two years later he went to Trafford Park, so that he now completes a period of 20 years' service with the Metropolitan-Vickers Company.

## The Telmacophone in Every Home



The Telmacophone in *your* home provides entertainment and instruction for every member of the family. No one has to take turns or miss any part of the program. No need to change headphones from one person to the other. You are always assured a loud, clear tone. Everybody can hear everything, clearly and distinctly.

The tone is produced by original Baldwin Type C. Unit and reflected into the outer horn. There is no metallic effect. Finished in black and gold to harmonize with any surroundings.

Correctly designed—fairly priced—unreservedly guaranteed. The ORIGINAL \$20.00 loud speaker and still the BEST. With original Baldwin Type C. Unit. Price complete \$20

If your dealer hasn't the Telmacophone in stock, send us his name and order direct from this ad enclosing \$20.00. Prompt shipment. Write for new free catalog.

**TELMACO**

Quality Radio Exclusively

**JOBBER! DEALER!** The demand for the Telmacophone is great. Write for new catalog and discounts on our complete line. We are also distributors for the better standard lines.

RADIO DIVISION  
**TELEPHONE MAINTENANCE CO.**  
20 S. Wells St. Dept. A Chicago, Illinois

## New Dubilier Variable Condenser

free with one subscription to "RADIO" for 18 months (\$3.75).

# "RADIO"

Pacific Bldg. San Francisco

Tell them that you saw it in RADIO

# BIG NEW STOCK OF RADIO SETS AND PARTS

Grebe CR-5 .....	\$80.00	Grebe CR-9 .....	\$130.00	Kennedy No. 220 .....	\$125.00
Grebe CR-8 .....	\$80.00	Kennedy No. 281 .....	\$80.00	Kennedy, No. 110 .....	\$250.00

## WE ASSURE YOU OF THE MOST PROMPT SERVICE

Our Radio Mail Order Service is gaining much popularity on account of the **FAST SERVICE**. We ship your order within four hours of its receipt. After you tire of waiting days—or maybe weeks—for your supplies, try Warner Brothers' Radio Mail Order Service and you will use no other. Following are a few items that we have in stock:

<b>VARIABLE CONDENSERS</b>		<b>AMPLIFYING TRANSFORMERS</b>		<b>RADIO FREQ. TRANSFORMERS</b>	
.0003 11 Plates Signal .....	\$3.00	ATWATER KENT .....	\$5.50	UV1714 .....	\$6.50
.0005 21 Plates Signal .....	3.50	UV-712 Radio Corporation .....	7.00	Radio Service Co. ....	8.00
.001 43 Plates Signal .....	5.00	231A GENERAL RADIO .....	5.00	ABROVOX .....	4.50
.0015 63 Plates .....	7.20	A2 AOMC semi-mounted .....	5.00	AOMC .....	5.00
.001 43 Plate Warner .....	4.00	Thordarson .....	4.50	<b>STORAGE BATTERIES</b>	
.0005 23 Plate Warner .....	3.50	BRYANT .....	5.00	6 Volt 70 A. H. ....	\$15.00
<b>EVEREADY "B" BATTERIES</b>		<b>JACKS AND PLUGS</b>		Philadelphia 6 V. 60 A. H. ....	18.00
No. 765, 22½ Volts .....	\$2.00	FEDERAL 1421 Open Circuit Jack .....	\$ .70	<b>LOUD SPEAKERS</b>	
No. 766, 32½ Volts, tapped .....	3.00	FEDERAL 1422 Single Circuit Jack .....	.85	E3 Magnavox Radio Type .....	\$45.00
No. 774, 43 Volts, tapped .....	5.00	FEDERAL 1423 Double Circuit Jack .....	1.00	E2 Magnavox .....	85.00
<b>REMLER APPARATUS</b>		FEDERAL 1435 Automatic Filament Control Jack .....	1.00	<b>VARIO-COUPERS</b>	
810 Jr. Rheostats .....	\$1.00	FEDERAL 1438 Automatic Filament Control Jack .....	1.30	REMLER 503 Cario-Coupler .....	\$5.40
813 3 Amp. Rheostats .....	1.75	PACENT UNIVERSAL .....	1.25	REMLER 505 Coupler on Unit Panel .....	12.75
330 Audion Detector Panel .....	8.50	<b>RHEOSTATS</b>		OUR OWN TYPE .....	3.50
331 Amp. Panel .....	6.00	REMLER Jr. ....	\$1.00	ATWATER KENT .....	8.00
333 Amp. Panel .....	9.00	PADA—with new Knob .....	.75	ATWATER KENT on Panel .....	13.00
96 Variable Grid Leak .....	.40	GENERAL RADIO No. 214 7 ohm or 2½ Amp. 2 ohm .....	2.25	<b>PHONES</b>	
97 Grid Condenser .....	.20	DEFOREST, new type .....	1.20	Federal, 2200 Ohms .....	\$8.00
<b>SOCKETS</b>		PARAGON .....	1.25	Federal, 3200 Ohms .....	10.50
156 GENERAL RADIO .....	\$1.25	MURDOCK 560 .....	1.00	Oory .....	8.00
GEORLEY Porcelain .....	.50	KLOBNIE .....	1.50	Western Electric, 2200 Ohms .....	10.00
KELLOGG .....	.75	JENKINS .....	1.75	Dictograph, 3000 Ohms .....	12.00
PARKIN .....	1.00	FRAMINGHAM .....	.75	Manhattan, 3000 Ohms .....	6.00
HOPEWELL .....	.80	OUTLER HAMMER .....	1.00	Manhattan, 3000 Ohms .....	7.00
<b>VARIOMETERS</b>		BEADLEYSTAT .....	1.85	Brandes, Superior .....	8.00
REMLER 505 Moulded Bakelite .....	\$7.50	FRAMINGHAM VERNIER .....	1.25	Lincoln, 3000 Ohms .....	7.00
OUR OWN TYPE .....	4.50	OUTLER HAMMER, VERNIER .....	1.50	Frost, 2000 Ohms .....	5.00
ATWATER KENT .....	8.00			Frost, 3000 Ohms .....	6.00
				Baldwin, Type C, E or F .....	pr. 16.00
				Master Baldwin .....	pr. 16.00

Now that you have read the list, get that order into the mails without delay. If there is something that you want and don't see it listed here, write us anyway and we will get it for you. Our two stores save still more time in getting your apparatus in a hurry. Enjoy the pleasure of real service for a change. Send us your orders.

San Francisco.  
350 Market Street  
Phone Douglas 4839

# WARNER BROTHERS

TWO STORES

Oakland, Cal.  
32nd & Telegraph Ave.  
Phone Lakeside 6233

Eventually you will buy better apparatus—

## The AMERTRAN

super - audio frequency amplifying transformer



Price \$7

Ask your Electrical Dealer, or, sent carriage charges collect. (Wt. 1 lb.)

WHEN a man interests himself in any hobby, such as photography, automobiles, or what not, he usually starts in by buying cheap, crude equipment.

Immediately he begins to realize that he wants better equipment, more skillfully designed apparatus.

It is the same with radio. Profit by your own experience in other matters and decide now that you will not be so handicapped.

The AmerTran has the greatest amplification (38.6 in one stage with Radiotrons)\* and is without distortion over the whole range of audio frequencies.

\*Send for leaflet No. 975.

## American Transformer Company

Designers and builders of radio transformers for over 20 years.

174 Emmet St.

Newark, N. J.

## Duck's Radio Catalog

No. 16—256 Pages

Continuously since 1909 Duck's Radio Catalogs have never been equalled for completeness and great wealth of radio data.

Send 35c in coin, carefully wrapped, for your copy of this wonderful book, the most unusual and complete catalog ever put between two covers. Not sent otherwise. It is not only a catalog, but a wonderful text book on radio. Enormous cost and tremendous demand

prevent further distribution at a less retailer.

Over 50 pages of latest hook-ups (wiring diagrams) and invaluable and up-to-date data and information on radio, including important instructions for building antennas.

Our new moulded variometer speaks for itself. For a comprehensive description of the design and radio thought back of our variometers, we invite your attention to our exhaustive description in catalog. In prettiness of design, compactness and lightness of weight, we have not seen any variometer that we believe compares with ours. The forms, unlike many others, positively will not warp. No. A900 plate variometer, with knob and dial \$7.25. No. A901 grid variometer, with knob and dial, \$7.25. Note.—If knob and dial are not desired deduct 75c.

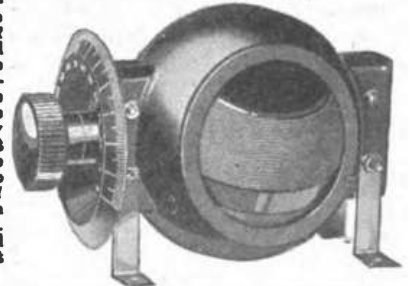

Duck Products have stood the test of time. The largest line in America—62 complete instruments—58 parts

### Dealers

We want live, responsible dealers in every city and town in the United States, both for the sale of our extensive line of radio apparatus and all other worth-while lines of radio goods, on all of which we can quote attractive dealers' discounts. We can offer you facilities and advantages that no other radio house can offer.

THE WILLIAM B. DUCK CO.  
248-250 Superior St.: - Toledo, Ohio

RECENT RADIO PATENTS

Continued from page 38

varying length. The control boards 5, 6, 7 and 8 are provided whereby an operator sitting in front of any of them is capable of plugging in a receiving instrument 12 in any combination of antennae so as to get the desired directional effect, as well as to select the proper antenna lengths for tuning.

**S. G. Frost, Pat. No. 1,424,294: August 1, 1922. Signaling Unit for Wireless Telegraphy.**

A high frequency generator is operated by handle 10 through gearing 9, and may be used in case of emergency to transmit a pre-determined telegraphic signal. This is effected by driving a segmented switch 17 by the same mechanism as that driving the armature 8 of the high frequency generator. The segmented switch 17 may at will be placed in series with the generator.

**L. DeForest, Pat. No. 1,424,805: Aug. 8, 1922. Subterranean Signaling System.**

A scheme is described for sending and receiving signals by currents conducted through the earth. For this purpose wires 20 and 21 are extended to a distance considerably below the earth's surface, such as to the stratum 8, where the conductivity of the earth is materially different from that at the surface. Tuning is resorted to, by the aid of coils 22, 23 in series with the circuit, which also includes a generator 9. It is stated that frequencies between 500 and 25,000 may be profitably employed, and that due to the absence of atmospheric disturbances, signals may be sent farther with the same energy than in ordinary radio signaling. At the receiving station, a system of wires similar to that shown is employed, and a detector is substituted for the generator 9.

**P. I. Wold, Pat. No. 1,424,866: Aug. 8, 1922. Method and Means for Relaying Modulated Carrier Waves.**

A system is described for relaying signals transmitted from station X through relay station Y to a distant station Z, of modulated carrier waves. In order that there be as little interference between the receiving end 8 and the sending end 17 of the relay station, the carrier waves transmitted at 17 have a frequency substantially different from that received at 8. To obtain this result without the aid of a separate source at station Y, use is made of the property of modulator thermionic tubes to produce carrier frequencies depending upon the tuning of the modulator circuits. Thus at station Y the modulator 5 produces frequencies equal to  $p + a$ ,  $p$ , and  $p - a$ , where  $p$  is the carrier frequency, and  $a$  the audible modulation frequency. By the aid of filter F one of the frequencies  $p + a$  or  $p - a$  is suppressed. At station Y the amplifier A is used to transmit the waves to a modulator 11, so tuned that it will produce a carrier frequency  $2p$ . Finally amplifiers A at 15 are arranged to amplify this new frequency, and the signal is transmitted in this condition from 17, and is detected at station Z in any appropriate manner.

**J. H. Hammond, Jr., Pat. No. 1,425,523: August 15, 1922. Transmission System for Radiant Energy.**

The transmitting antenna 10-11-12 may be rendered active from any one of a plurality of stations 60, 61 or 62, and the arrangement is such that if any one station is transmitting, this may be determined from any one of the stations. The coil 40 controls the switch that closes the circuit for transmitting alterator 19, and the circuit for this coil is controlled by any one of the switches 80, 81 or 82 located at the control stations. All of the stations are linked by telephones through inductive circuit 46, 47, 48, so that conversa-

Continued on page 102

Tell them that you saw it in RADIO

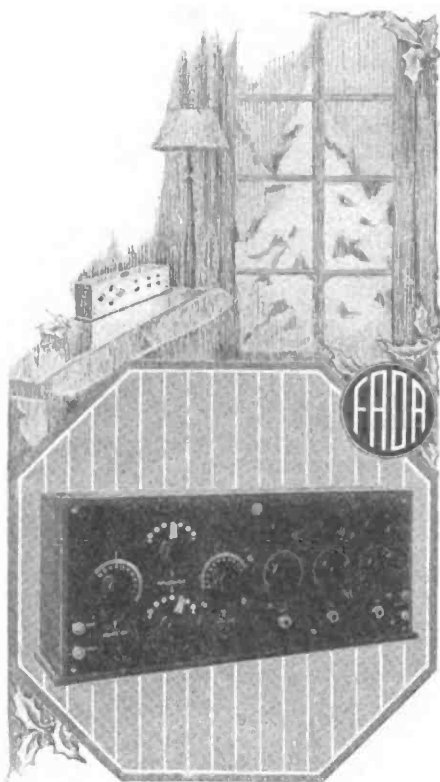

Make This A Radio Christmas

Extend Christmas cheer throughout the coming months by topping the family gift list with a Fada Receiver-Amplifier.

From the oldest to the youngest, every member of the household can easily operate and enjoy this master instrument, commanding as it does, entertainment from various broadcasting stations, bringing it, in true clearness of tone, to your own fireside.

Although, a very simple instrument, the Fada receiver-amplifier, embodies those true refinements typical of all Fada equipments and parts.

F. A. D. ANDREA

1581-F JEROME AVE., NEW YORK CITY

Manufacturer of Fada rheo-stats, tuners, switches, vario-couplers, sockets, detectors, condensers, audio frequency amplifiers, etc.

Write for the Fada Handbook enclosing 5c to cover postage, mentioning your radio dealer's name and address. It's plumb full of things about radio you ought to know.



Fada Receiver-Amplifier

The Latest and Most Essential Part of an Efficient Tube Set

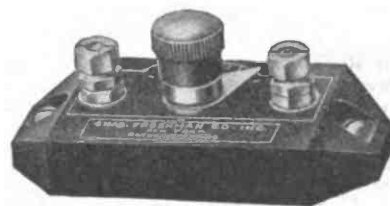

Variable Grid Leak and Micon Condenser

(Combined)  
Obtainable in an unbroken range from zero to 5 megohms—all intermediate points. Fixed capacity—.00025 M. F. Will improve your set wonderfully by Clarifying Signals

Lowering Filament Current  
Increasing Battery Life  
Eliminating Hissing

Price only \$1

At your dealer's—otherwise send purchase price and you will be supplied without further charge.

Chas. Freshman Co., Inc.

97 Beekman Street, New York City  
Home of Micon and Antenna

KNOTT Super-vernier Condenser

(Trade Mark Registered)

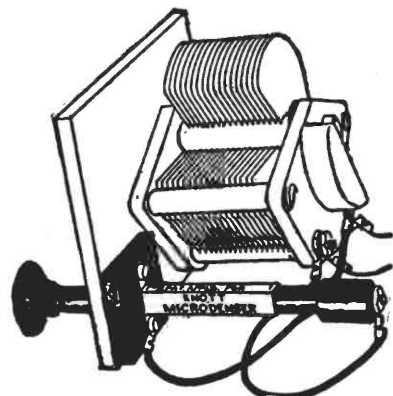

Showing how you connect to your condenser

Tune your condenser to the whistle and bring in the message with this Micro.

It will stretch the critical adjustment on your condenser to two inches of adjustment.

Buy it of your dealer or send us \$3.00 for one by return mail postage paid complete with connecting wires and wrench-screwdriver.

Ask about Knott Sure Ground, Knott Radio Name Plates, Patent Dial, Rheostat, Quodeoil, Cinquoil, Microstat.

Jobbers write for our proposition, it will interest you.

E. R. Knott Machine Company, 1 Ellery St., Boston 27, Mass.

A New Perfected Crystal



Every STANDARD CRYSTAL is tested on the Radio Waves before and after mounting. We guarantee every crystal we sell. Jobbers and dealers be convinced.

send for a free sample of the STANDARD SPECIAL CRYSTAL, sold mounted and unmounted. All orders shipped the same day received.

STANDARD CRYSTAL CO.  
274 Halsey St. Newark, N. J.

## RT-5 and RT-6 Have taken the "Freak" out of RADIO FREQUENCY

The RT-1 Frequency Transformer covering a range of 175 to 500 meters, built by the Radio Service Laboratories, has long been recognized as the best transformer of its kind on the market. It is with pardonable pride that we announce to the trade as well as radio enthusiasts that our engineers, ever striving to anticipate the public demand, have just completed two new types of radio-frequency transformers that are far ahead of anything on the market today. Realizing that it is impossible to obtain maximum efficiency for both the amateur, who builds his own set and is only interested in CW work; and for the man who purchases his set and is only interested in the broadcast reports and entertainments, we have perfected a transformer for each class. We have more than doubled the amplification by cutting the range in half. This not only means a wonderful step forward in results obtained but also eliminates to a great degree the critical features which have heretofore retarded the developments of radio frequency amplification.

The beginner need fear no difficulty in operating these transformers in cascade successfully with a large gain on each stage—without the advice of a consulting engineer to guide his efforts.

### AS A RESULT WE NOW OFFER

**TYPE RT-5** a transformer of high radio frequency amplification specially selected for the first stage for the amateur range only, 150 to 300 meters. RT-5A is a transformer that is interchangeable for the second and third stages.

**TYPE RT-6** a special transformer of equally high radio frequency amplification for the first stage, for the broadcast range only, 300 to 600 meters. RT-6A is a transformer that is interchangeable for the second and third stages.

These new types are put through the famous triple test and are still the only completely shielded iron core radio frequency transformers on the market. These new types have literally taken the "Freak" out of Radio Frequency and give

"Louder Signals with less noise  
Greater Range with same equipment."

**RADIO SERVICE LABORATORIES** Transformers by actual test are superior to any domestic or foreign make in the market. For sale at reliable electrical shops or stores where Radio supplies are sold.

**ALL TYPES RETAIL AT \$8 EACH**

Send for your complimentary copy of booklet on Radio Frequency with schematic diagrams.

## Rasla Sales Corporation

National Distributors  
Dept. C, 10 East 43d St., N. Y. City  
Western Sales Agents  
Detsch & Company  
555 Turk Street, San Francisco, Calif.  
Western Radio Distributing Co.  
1114 L. O. Smith Building, Seattle, Washington.





## How to stop noises when you touch dials

Have you ever found, after tuning in a distant broadcasting station, that when you removed your hand from the dial there is a growling noise which makes it impossible to hear anything else?

This is usually caused by two things—too much current through your tube filament and dials made from resinous and other compounds which, being comparatively poor insulators, cause body capacity to make proper tuning an impossibility.

If you are positive that the proper amount of current is flowing through your filament and these distracting noises still persist, they can be overcome only by removing the dials at present on your set and replacing them with dials made of RADION.

Tests have proved time and again that RADION is without question the supreme insulating material for Wireless use.

Secure a RADION dial from your dealer today. Take it home and place it on your set and you'll notice the difference immediately. Also have your dealer show you a RADION MAHOGANITE panel—the most beautiful panel made—easy to saw and drill. It is also warp and chip proof.

If your dealer can't supply you write us direct giving us his name and we'll see that your requirements are immediately taken care of.

## American Hard Rubber Co.

11 Mercer Street New York

**U.S.A. Aviation Type 194-W**  
WESTERN ELECTRIC PHONES  
Each Phone Cap is covered with large soft rubber ear cushions, and an aviation leather helmet goes with each set!  
**\$7.95**  
CHICAGO SALVAGE STOCK STORE  
509 S. State St., Chicago, Ill.

**A POSTAL CARD**  
Will Bring Our Latest  
**RADIO FOLDER**  
THORDARSON ELECTRIC MFG. CO.  
500 W. Huron St. CHICAGO

**6th District  
Amateur Calls**

will be published every  
week in  
"BROADCAST PROGRAM"  
A new 32-page weekly.  
Price 5c per copy—\$1.00  
for 26 issues.  
Send for free sample copy  
"RADIO," Pacific  
Bldg., S. F., Cal.

**Be Sure and Read the Radioads on Page 111**

Tell them that you saw it in RADIO

**Quality Design**  
**+ Workmanship**  
**+ Materials**  
**= RELIABILITY**



This unit is the product of a firm of pioneers in the battery charging field. Our commercial apparatus is used in thousands of the best equipped battery service stations in the country.

Materials and workmanship are the finest available.

Radio "A" is built, not assembled.

Simple to use—Just plug in at any 110 v. A. C. lamp socket—attach clips to battery—turn on current and you have your own charging plant.

Only one moving part, which will last for several thousand hours.

The only Recharger with a *one piece* Removable Vibrator, can be replaced by a child.

Think of the convenience of not having to carry your battery to the Service Station this winter.

The Battery will always be full of pep.



A compact portable Recharging unit that will fully charge a 100 AH battery overnight for 5 to 10 cents.

A useful and lasting Xmas Gift. Lasts a lifetime.

**King Electric Manufacturing Co., Inc.**  
 1681 Fillmore Ave.,  
 Buffalo, N. Y.

Continued from page 100

tion may take place between them. Further, when the transmitting circuit for the antenna is active, a buzzer 88 in a box 85 is also active, and may be heard in any of the phones 73, 74 and 75. In this way each operator may know whether radiation is going on. There is also a metronome 86 in the box 85, the beats of which may be used as a guide by the operators for the lengths of their dots and dashes.

**R. A. Weagant, Pat. No. 1,425,154: August 8, 1922. Apparatus for Receiving Radiosignals.**

It is stated that atmospheric disturbances which are so objectionable in receiving, act as if they were propagated downward in a vertical direction. Therefore to eliminate these disturbances, a grounded screen 5 may be used, consisting of a series of parallel conductors, under which the collector 10 may be situated. Electromagnetic signaling waves are but slightly hampered by the screen 5, since they travel mainly in a horizontal direction.

**E. A. Sperry, Pat. No. 1,426,337: Aug. 15, 1922. Signaling Apparatus for Detecting Submarines.**

A device is described that is actuated to transmit a code signal by radio upon the entangling of a submarine in a net. All of the operative parts are associated with a submerged buoy 1 adapted to be released and to rise when the net is pulled away by the submarine, and rises to the surface. Within the buoy are a radio transmitting set 16 and a battery 15, the set 16 including a motor driven code wheel. The buoy carries an antenna system 8, 9, and as switching device 84 is used for causing the transmitting system to operate when the buoy rises. The entire buoy interior is carefully shut off against moisture, and to absorb any that may come in, a mass of calcium hydroxide is located in the bottom.

**F. N. Waterman, Pat. No. 1,426,132: Aug. 15, 1922. Electrical Measuring Instrument.**

A measuring scheme is described for the direct measurement of the decrement of damped waves in any circuit. For this purpose the measuring circuit shown is loosely coupled by the aid of coil 1 to the circuit to be measured, and the decrement of this measuring circuit is made as low as possible in order to reduce the error due to this factor. Use is made of the formula  $d_1 + d_2 = \frac{C_2 + C_r}{C_2 + C_1}$  given by Bjerknes, where

$d_1$  = decrement of circuit under test per cycle,

$d_2$  = decrement of instrument circuit per cycle,

$C_r$  = capacity of instrument circuit at resonance,

$C_2$  = capacity of instrument circuit off resonance, with longer wavelength than at resonance, and

$C_1$  = capacity of instrument circuit off resonance with shorter wavelength.

It is seen that if in this formula  $C_r$  and  $C_2$  are maintained constant, for every value of  $C_1$  there corresponds but one value for  $d_1 + d_2$ . The measuring circuit is arranged so that a change in a capacity will cause a direct change in reading for  $d_1 + d_2$ .

**J. H. Hammond, Jr., Pat. No. 1,425,522: August 15, 1922. System for Sound Transmission.**

A receiving antenna 110 is arranged to cause the selective actuation of sound transmitting diaphragms 10, 11, 12. Each of these diaphragms is arranged to vibrate at its own selected frequency by the use of appropriately driven interrupters 45, 46 and 47. The control of these diaphragms is effected

Continued on page 104

Tell them that you saw it in RADIO

# CHELSEA CONDENSERS



No. 1

## PRICES :

No. 1 Table.....	.001	\$5.00
No. 2 Table.....	.0005	4.50
No. 3 Panel.....	.001	4.75
No. 3a Panel without dial..		4.35
No. 4 Panel.....	.0005	4.25
No. 4a Panel without dial..		3.85
No. 5 Panel.....	.00025	3.75
No. 5a Panel without dial..		3.35
No. 6 Panel vernier.....		2.90
No. 6a Panel without dial..		2.50
No. 7 Panel with vernier....		6.50
No. 8 Table with vernier....		6.75

**Genuine Bakelite Construction**

The best and most complete line of condensers in existence.

Write for our catalog No. 7

**Chelsea Radio Co.**  
 152 Fifth Street  
 CHELSEA, MASS.



CRYSTAL RECTIFIER  
 MULTIPPOINT  
 (Patent Pending)

## A Synthetic CRYSTAL DETECTOR

Sensitive Over Its Entire Surface  
 Eliminates All Detector Troubles.  
 50% Increase in Clearness and Volume.  
 Endorsed by Radio Experts and Press.  
 Sold in Seal Packages Only.  
 Sets a New Standard of Efficiency.  
 Price Postpaid, Mounted 50c  
 Sensitiveness Guaranteed  
 Dealers and Distributors Quoted  
 Attractive Discounts

RUSONITE PRODUCTS CORPORATION  
 Dept. "R", 15 Park Row, N. Y.

RADIOADS ON PAGE 111



**VERNIER Rheostat  
Model 200**

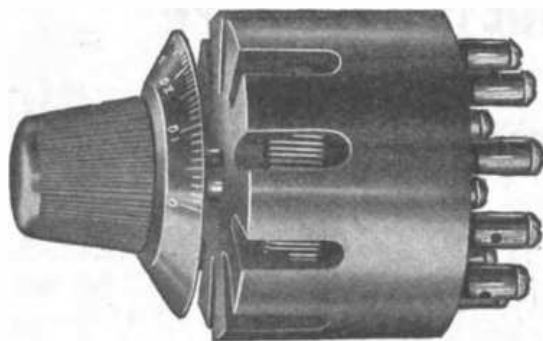
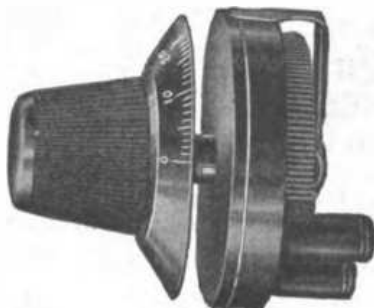

**The AMPLITROL**

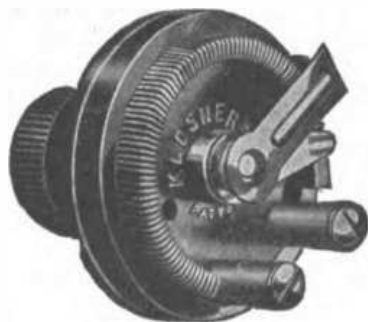

**Model 100  
The ORIGINAL  
VERNIER Rheostat  
\$1.50**

**No Panel can be up-to-date  
without these two**

**Only a rheostat with a vernier can make your set more sensitive.**

It is impossible to tune out interference without perfect adjustment of your detector tube. No ordinary rheostat can give you the fine adjustment necessary.

The Klosner **VERNIER Rheostat** has a micrometer adjustment that permits getting **EXACTLY** on the very spot for perfect reception.

The Klosner operates both course and fine adjustments with **ONE** knob—a feature protected by broad patent claims. Wire-wound like all true electrical instruments.

And it has a graduated **DIAL** to show just where it is set. No guessing.

Condensite, phosphor bronze contacts, white graduations on black dial, **\$1.80.**

**Does away with plugs and jacks—makes tubes last many times longer.**

Now, for the first time, you can have complete control and adjustment of each amplifier tube merely by turning a simple knob. Do away with all jacks, plugs, rheostats and switches. The **Amplitrol** knob switches on the plate circuit and adjusts the filament circuit at the same time. You turn on any stage of amplification at will.

Lengthens the life of the tube from one-third to one-half, as it absolutely prevents suddenly throwing a heavy current onto the delicate filament. With the **Amplitrol**, the current is turned on **GRADUALLY.**

Genuine condensite, white graduations on a black dial, phosphor bronze contacts. Highest grade. Complete with wiring instructions, **\$4.00.**

If your dealer cannot supply you, don't make the mistake of accepting something "just as good." We will take care of your order direct.

**KLOSNER IMPROVED APPARATUS CO.**

*Originators and Sole Manufacturers*

**2024 Boston Road, New York City**

**DEALERS**  
*No instruments on the market surpass the Klosner in neatness of design or quality of material and workmanship. Show your customer a Klosner and any other kind—he selects the Klosner regardless of any difference in price. Order through your jobber.*

**K L O S N E R**

Tell them that you saw it in RADIO

Hit it anywhere!



RADIO BRINGS IT.  
MAGNETITE MAGNIFIES IT.  
"G-D" HEADPHONES TELL IT.

"MAGNETITE RADIO CRYSTAL"

It Magnifies—Replace this new marvelous crystal for your old one and hear broadcasting louder and clearer. The most sensitive mineral on the world market. Unaffected by handling or moisture and will render efficient service indefinitely. Price per crystal, 50c, postpaid any part of the U. S. Dealers, write for our proposition.

"G-D"  
RADIO HEAD SETS  
3000 ohms \$4.25 postpaid

Satisfaction guaranteed on all our products or money refunded. Enclose money order or bank draft; currency by registered mail only. Write for catalogue on our complete line of radio equipment.

GIBBONS-DUSTIN RADIO MFG. CO.

518 W. 9th St. Department "S" Los Angeles, Calif.

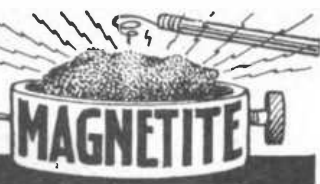

Continued from page 103

by the aid of electromagnetic switches 60, 61 and 62, so that the group frequency of waves received by the antenna 110 determines which of these switches will be energized. To secure this result the circuits for the mercury vapor relays 70, 71 and 72 are tuned respectively to the different group frequencies.

R. A. Weagant, Pat. No. 1,426,133: August 15, 1922. Apparatus for Static Interference.

Use is made of the fact that static interference waves appear to travel in a vertical direction, while signal waves appear to travel mainly in a horizontal direction. Thus loops 1 are behind one another by an appreciable distance so that signal waves do not act on them simultaneously, but static disturbances do. These loops are connected opposite to each other, and therefore the interferences are annulled. A detector 10 of any suitable type may be coupled to an inductance coil 7 in either or both loop circuits.

G. M. Wright, Pat. No. 1,426,137: Aug. 15, 1922. Radiogoniometer.

In one type of radiogoniometer, use is made of two collector circuits at right angles to each other, and each connected in series to a stationary coil such as A, B. Within these two coils a coupled search coil is rotatable, the position of which is adjusted to give a maximum or minimum effect. The present improvement resides in making the search coil in two parts, C and D, at an acute angle with respect to each other and in series. Due to this arrangement errors arising from variations in coupling between the search coil and coils A and B, as the search coil is rotated, is minimized.

R. A. Heising, Pat. No. 1,426,733: August 22, 1922. Method and Means for Preventing Amplifiers from Oscillating.

When one or more thermionic amplifiers A and A' are used between a source I and a load circuit such as L, there is a tendency for the tube to oscillate, due to capacitive coupling between the various electrodes of the amplifiers. It has been found possible to overcome this tendency by causing the output circuit to have a comparatively high inductance, as by the insertion of a coil L<sub>1</sub> therein.

W. Wilson, Pat. No. 1,426,801: Aug. 22, 1922. Repeater for Undulatory Currents.

A luminous discharge repeating device is described in which there are four electrodes; a heated filamentary cathode 4, a perforated auxiliary electrode 6, an anode 5, and a control electrode 8 of disc shape, placed very near to the cathode 4. By heating filament 4 and impressing an undulatory e.m.f. upon control electrode 8, a luminous, varying discharge is produced between electrodes 6 and anode 5. By making electrode 6 in the form of a wall between cathode and anode, and by providing the control electrode 8, deleterious luminous discharge between cathode 4 and the auxiliary anode 6 is prevented.

E. F. W. Alexanderson, Pat. No. 1,426,944: August 22, 1922. Radiosignaling System.

A multiplex transmitting system is described, in which a plurality of audio frequency sine waves may be simultaneously superimposed upon a radio frequency wave transmitted from antenna 1. Thus a "magnetic amplifier" 8 is shunted across the coupling coil 7 of a transformer 3 which transmits energy to the antenna 1. By varying the magnetic field in the amplifier legs 9 and 10 at any frequency, corresponding variations are obtained in the amplitudes of the transmitted radio waves. To produce these variations at audio frequency, alternators 19, 20 and 21 are provided, controlled by signaling keys 28, 29 and 30. When any of these keys are depressed, audio frequency

Continued on page 108

THE LITTLE GIANT RECEIVER

The Metropolitan Radio Corporation of Newark, N. J., is marketing a crystal receiving set of unusual attractiveness—the "Little Giant." It is housed in a walnut cabinet with bakelite panel. Tuning is easily accomplished by merely pulling out a rod until the signals are clear and sharp. All connections are soldered and, through special construction, the crystal detector maintains its adjustment almost indefinitely. The set is equipped with a pair of Metropolitan phones.

P. O. NAMES ITS RADIO STATIONS

The Post Office Department has announced for the information of radio users the call letters of all radio stations used for air mail, post office business and broadcasting. The stations and their letters are as follows: Washington, WWX; Hazelhurst, WWU; Bellefonte, WWQ; Cleveland, NRH; Chicago, NAJ; Iowa City, KIOTS; Bryan, O., KDEL; Omaha, KDEF; North Platte, KDHM; Cheyenne, KDEG; Rock Springs, KDHN; Salt Lake City, KDEH; Elko, KDEJ; Reno, KDEK; San Francisco, NPG. Market and weather reports are broadcasted by the Post Office stations and can be received by amateurs.



Galena Crystal, Mounted... 35c  
Galena Crystal, Unmounted... 25c  
IMMEDIATE DELIVERY  
Manufacturers, Jobbers, Dealers,  
write for quantity prices

GALENA CRYSTAL MFG. CO.

2895 Fulton St. Brooklyn, N. Y.

Atlantic Jr. Crystal Set

Very good Christmas Merchandise  
List Price... \$18.00  
With double phones and Antenna Equipment.  
Attractive Discounts.

Atlantic Instrument Co., Inc.

13-21 Park Row New York City

RADIO MAILING LISTS

9270 Retail Radio Dealers by states... per M. \$7.50  
1084 Radio Manufacturers... per list 10.00  
1280 Radio Supply Jobbers... per list 12.50  
260 Radio Stations... per list 4.00  
14,000 Radio Mfrs. & Managers of Radio Stations... per M. 7.50  
Guaranteed 98% correct. Send remittance for what you order.

TRADE CIRCULAR ADDRESSING CO.  
164 W. ADAMS ST., CHICAGO, ILL.

TO RADIO DEALERS

State Territories NOW open. Aggressive Dealers can make good profit selling Guaranteed Radio parts. Write for Complete Information

Ray-Di-Co. Organization, Inc.

1215 Leland Ave., Chicago

Every Week

"BROADCAST PROGRAM"

Write for free copy

"RADIO," Pacific Bldg., S. F.



Dubilier  
Micadon  
Type 601

Free with  
one subscription  
to "RADIO"

(Mention Size)

"RADIO"

Pacific Bldg. San Francisco

Tell them that you saw it in RADIO

**Let Radio Radiate Your Home**

AMATEURS: Buy direct from Distributors. We sell you at wholesale prices. Send us your mail orders.

	List Price	Our Price
Everett Phones....	\$8.50	\$5.50
Furney Phones....	6.50	4.45
Phordarson Trans..	4.50	3.85
Radio Frequency Trans. ....	3.00	2.25
Detector Tubes....	5.00	4.25
Amplifier Tubes...	6.50	5.50
Vernier Rheostat..	1.50	.95
Dial & Knob, Unbreakable .....	1.00	.30

Catalogue containing hundreds of values free on request.

**Perfection Radio Corp.**  
of America  
149 West 23d Street  
NEW YORK, N. Y.

**PRMCO Control Units**

**Insure Best Results**

Scientifically correct Detector and Amplifier Units that are inexpensive, but that insure results equal to larger and far more expensive sets. Compact, attractive, easy to put into circuit. Correct capacity for latest type reception tubes.

PRMCO AMPLIFIER Units give maximum amplification without distortion—  
Price .....\$15.00

PRMCO DETECTOR UNITS ..... \$9.00

—Special Prices to Dealers and Jobbers

—Send for Descriptive Bulletins

**Ports Radio Mfg. Co.**  
—Distributed by QST Radio Shop,  
Fresno, Cal.  
3305 Belmont Ave., Fresno, Cal.

**3000 OHM SETS \$3.98**  
PLUS 20 CTS. POSTAGE AND PACKING  
Satisfaction Guaranteed or Money Back



We mail phones the day your order arrives. Every pair tested, matched, and guaranteed as sensitive as \$8 to \$10 Sets. Circular Free.

**Tower Mfg. Company**  
108 STATION ST., BROOKLINE, MASS.

Sensitive Tuning Range 200-600 meters

Price **\$110** without tubes

**The Most Sensitive Receiving Set on the Market!**

Embodying NEW inventions—affording higher RADIO FREQUENCY amplification—and wider sensitive tuning range—than heretofore obtainable. This remarkable 3-STAGE RADIO FREQUENCY AMPLIFIER-DETECTOR SET is now perfected and ready for distribution.

*Ware*  
**TYPE AD2**  
R-F AMPLIFIER-DETECTOR  
**RECEIVER**

With Clear, Crisp and Perfect Tone Reproduction, the AD2 Receiver will readily bring in the broadcasted programs hundreds of miles on 1 ft. indoor coil aerial—Easily receives signals which are totally inaudible on the usual regenerative type receivers—

For long distance reception the AD2 Receiver, loose-coupled to an outdoor aerial, has yet to be equalled. An attractive and entirely reliable instrument—simple to operate—the result of over 5 years' continuous experiment and development by our engineers.

Dealers' Correspondence Invited—Descriptive Booklet on Request

**WARE RADIO CORP'N**  
160 - 162 Duane St. NEW YORK CITY

**Most Complete Radio Stock in DENVER**

Clapp-Eastham Receiving	Jewell Meters
Grebe Receiving	Aome Transformers
Kennedy Receiving	ESCO Motor Generators
Murdock Equipment	Eby Binding Posts

Send 15c for our "Radio Guide"—Refund on first order of \$5 or over

**Operating KLZ and 9ZAF**

**REYNOLDS RADIO CO., Inc. DENVER**  
1524 Glenarm Street COLORADO

**See Classified RADIOADS on Page 111**

Tell them that you saw it in RADIO

# ATWATER KENT

## RADIO RECEIVING SET

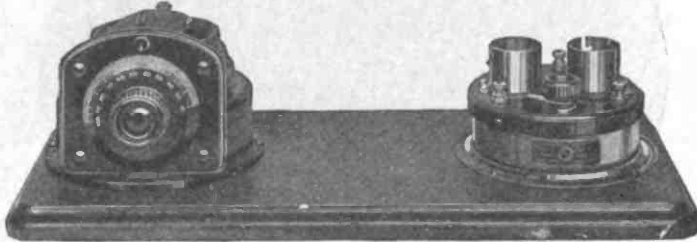

THE two instruments shown above comprise an excellent and complete receiving set. The Coupled Circuit Tuner and Detector Amplifier on the mahogany board present a beautiful appearance. Complete outfit as above, unwired, \$32.00

ATWATER KENT MANUFACTURING COMPANY  
4947 STENTON AVE. Radio Dept. PHILADELPHIA, PA.

# PRICES SMASHED

Each sale has created new friends with the result that we are now able to announce drastic cuts in our quality lines. Send card for full list or order from the following sample savings.

Parts for Regenerative Vacuum Tube Receiver		Our price	Others
Approximate range 1000 miles			
Panel of bakelite 7 in. x 12 in. already drilled		\$1.65	\$2.40
Cabinet of 3-ply wood to fit above		1.50	2.50
16 switch points with nut at 1c ea.		.16	.48
4 switch stops with nut at 1c ea.		.04	.12
2 three-inch dials at 35c each		.70	1.40
1 vario-coupler with 7 multiple and 7 single taps		2.25	4.00
8 binding posts, nickel-plated, at 3c each		.24	.48
2 switch levers at 25c each		.50	.90
1 filament rheostat, highest quality		.65	1.10
1 23-plate variable condenser		1.95	3.50
1 tube socket of high quality		.45	.85
1 tube socket bracket to allow panel mounting		.15	.25
1 phone and one grid condenser at 10c each		.20	.50
12 feet highest grade spaghetti tubing at 4c		.48	.84
15 ft. tinned copper connecting wire		.30	.45
1 set of drawings giving wiring details		.10	.25
Frost Phones	2000 ohms	\$11.32	\$20.02
Kellogg's	2400 ohms	\$8.95	\$5.06
Transformer, Audio frequency, highest grade		2.85	4.50
Variometer, hardwood stators, wound and assembled		2.45	4.00
Amplifier Unit, two stage, knocked down, including cabinet, drilled 7x12 panel, 2 transformers, jacks wire, spaghetti, binding posts, rheostats, tube sockets, etc.		12.95	23.50
Amplifier Unit, as above wired and in cabinet		18.95	35.00
Vacuum Tube Receiver, wired and in cabinet		17.95	35.00

All goods prepaid and sent subject to return for rebate or exchange. You simply must be pleased. You'll tell your friends.

## RADIO PARTS MANUFACTURING COMPANY

6 Park Place — Detroit, Michigan

## KING Rheo-Socket

ANOTHER RADIO SURPRISE

Price \$3, f. o. b. New York City

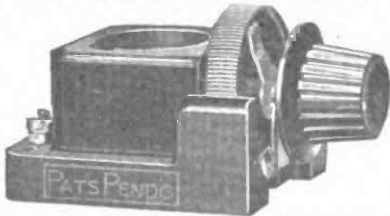

Compact, increased efficiency, shorter connections, less wiring—brings in stations you never heard before. Make this a part of your up-to-date set.

A high grade article in Red Bakelite with Phosphor-Bronze Contacts and Alloy Resistance Wire.

FOR BASE OR PANEL MOUNTING  
**KING AM-PLI-TONE**

82 Church Street New York  
Mfrs. of the Famous KING AM-PLI-TONE  
Jobbers, wire or write for proposition

## MAGNET WIRE

ONLY BEST GRADE CARRIED IN STOCK

¼ lb. D. C. C. on Metal Spool			
Size	Price	Size	Price
20	\$.52	26	\$.74
22	.57	28	.85
24	.63	30	.98

### A FEW POPULAR RADIO ITEMS

Contact Points—Nickel Plated and Polished	
No. 1—¼" dia. x ½" high, each	\$.02 ½
No. 2—¼" dia. x ¾" high, each	.03
No. 3—¼" dia. x 1" high, each	.03 ½
No. 4—¼" dia. x 1 ¼" high, each	.03 ½
No. 7—Switch Stops ¾" high, each	.03 ½
No. 8—Switch Stops ½" high, each	.04
No. 12—Posts, Nickel Plated and Polished	.08
No. 116-A—Fada Posts	.12
No. 114-D—3 plate Vernier Condenser	1.50

Mail orders promptly filled when accompanied with check or money order.

Postage Charges Prepaid

Dealers Write for Discounts

**DAVID RADIO SUPPLY CO.**  
P. O. Box 596 Reedley, Calif.

## MANUFACTURERS & JOBBERS

A  
MAILING LIST  
OF DEALERS  
to our Advertisers

The  
**RADIO RED BOOK**  
CIRCULATION 25,000

radio trade  
directory &  
buyers' guide

120 PAGES — PRICE \$1.00

write for rates

**RADIO RED BOOK**  
PUBLISHING CO.  
406 West 31st., NEW YORK CITY



## ERLA PLUGS

Given free with one subscription to "RADIO."  
Mailing charges, 12c.

"RADIO"  
Pac. Bldg., San Francisco, Cal.

Tell them that you saw it in RADIO

# The Audiophone Loud Speaker Method of Receiving Makes You Forget It Is Radio Phone



**AUDIOPHONE SE.**  
Horn 15-inches Dia.  
Price \$40.00



**AUDIOPHONE JR.**  
Horn 11 inches Dia.  
Price \$22.50



**ONE STAGE POWER  
AMPLIFIER**  
Price \$25.00

## So Like the Original Voice and Orchestral Instruments

the tone is big in volume, rich, round and free from mechanical distortion. The result of over six years' work on "Sound Reproduction" in the laboratories of The Bristol Company, a world known engineering firm, the Audiophone is not a temporary piece of equipment, but a permanent contribution to the Radio Field.

NO AUXILIARY BATTERIES are required for magnetizing.

About one watt is necessary to give the Audiophone full volume.

Most amplifiers are two stage and designed to give good response in head phones, but there is not sufficient power to operate loud speaker, except for small audiences. For this reason it is desirable to provide another stage of power amplification, and Bristol's One Stage Power Amplifier is available which will give volume enough to be easily heard in a room seating 500 persons and over, when added to one or two stage amplifier.

Our representatives are located in all parts of the country. We can come to you with demonstration. Shall we send bulletins?

**The Bristol Company**  
WATERBURY    ::    ::    ::    CONNECTICUT

MAKE THIS A RADIO CHRISTMAS

*It's a Long  
Long Way*

To Some of the Broadcasting Stations  
You Can Pick Up—With a

**Federal**

**DX TYPE No. 58 R. F. RECEIVER**

An Instrument of Great Selectivity and Exceptional Long Range

IF YOU DON'T LIKE THE PROGRAM YOU ARE LISTENING TO—  
YOU MAY FIND ANOTHER MORE SUITED TO YOUR TASTE

Bulletin No. 119-W describes Radio Frequency Apparatus in detail—Copy mailed on request

**Federal Telephone and Telegraph Company**

MANUFACTURERS OF STANDARD RADIO EQUIPMENT

**BUFFALO, N. Y.**

Western Branch Office: 693 Mission St., San Francisco, Cal.

DX Type No. 58 R. F. Receiver



Tell them that you saw it in RADIO

# BUY THE BEST

## Thordarson Condensers and Amplifiers

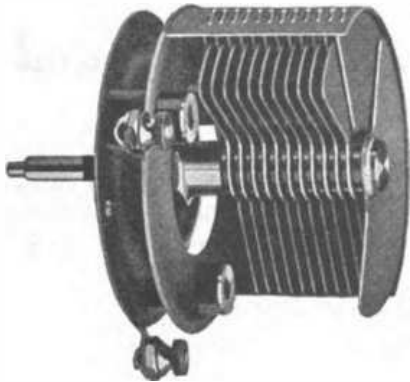

### A New Thordarson

6 to 1 ratio audio frequency amplifying transformer. Designed for those desiring a higher transformer ratio than our standard. Unusually high and constant amplification without distortion over a broad band of audio frequencies. Core is twice the cross section of that of the ordinary amplifying transformer and is made of special 36 gauge silicon steel. The coils have low distributed capacity. The high "Thordarson" standard has been maintained throughout.

6 to 1 ratio transformer.....\$5.00  
3½ to 1 ratio transformer 4.50

### Thordarson Electric Mfg. Co.

500 W. Huron St.  
CHICAGO

### Our Latest Product

The best, most flexible and most complete variable condenser on the market today at any price.

Some of its features are:

Movable and stationary plates completely shielded.

Stationary plates spaced accurately by special punched shell.

Movable plates secured by an ingeniously assembled comb separator brushing against the bearing.

Single bearing fastened directly to the shielding base plate without any dielectric.

Assembled by machine.

Lowest possible zero capacity and dielectric loss.

A Vernier can be added by anyone at any time at a very small cost.

13 plate .00025 M.F.....	\$2.00
with vernier, knob & dial	3.50
25 plate .0005 M.F.....	2.50
with vernier, knob & dial	4.00
43 plate .001 M.F.....	3.00
with vernier, knob & dial	4.50
Vernier furnished separately if desired with knob .....	.60

Continued from page 104

waves impressed upon antenna 1, and the alternators 19, 20 and 21 are arranged to supply different audio frequencies. At the receiving station, a plurality of receiving circuits may be provided, each tuned to its own special audio frequency so as to receive signals transmitted by one of the keys 28, 29 and 30, or else a switching arrangement may be provided to connect a single device so as to be sensitive to any one of the plurality of audio frequencies.

J. Bethenod, Pat. No. 1,427,350: Aug. 29, 1922. Radiotelegraphic Coupling.

In order to prevent circulatory currents between armature section  $C$ ,  $C^2$  and  $C^3$  of a high frequency alternator, they are each connected to individual transformer primary coils  $T^1$ ,  $T^2$  and  $T^3$ , while their secondaries are connected in any appropriate manner to the antenna  $A$ . Further in order to decrease the dielectric stress, the midpoint of each of the armature sections is connected to the midpoint of the corresponding transformer winding, and all these midpoints are connected to ground at  $E$ .

### LETTERS TO THE EDITOR

Continued from page 34

to allow some wild ham with \$8.16 worth of second-hand five-and-dime-store junk to put \$3000 or \$4000 worth of apparatus out of business. Even if the "novice" could afford to change, I doubt the results. I frequently use my Grebe CR-8, and there is the spark "frog" strong at 400 and annoying at 360. On my Westinghouse RC, the spark blankets everything for the entire range, and putting in the loading coil—1800 to 2800 meters—makes no difference, excepting that he is stronger, if anything. But, of course, sparks can't be heard above 200 meters!

As to the comparative value of the amateurs' code and the broadcasting program, only one idea can prevail. The broadcast is by far the more important of the two. The amateurs are always yelling: "Look what the amateur has done for radio!" but they seldom get down to concrete facts and say *what* he has done. And when they do, you usually find out he wasn't an amateur, anyway. As to the amateurs "handling messages, free of cost, for the public," they may—and probably do—shoot a lot of semi-useless stuff into the air which wouldn't otherwise be there, but its value is doubtful, to say the least. The spark hog who is getting every one's goat in this town isn't doing anything but jam the air. His sending is rottenly ragged, and he tries to "step on her" so fast that he is always falling over himself. No one could possibly read him. At times he spends several minutes sending his own call, and at other times he just holds his key shut for twenty to thirty seconds. It is lovely, in the middle of a violin solo or a symphony orchestra number. But, of course, as he is "handling messages for the public, free of charge," all novices—and others—must grin and bear it and say how nice it is that sparks can't be heard on the broadcast wavelengths.

So long as the amateur takes the position that the amateur is king, and that "the king can do no wrong," just so long is he going to have trouble. The letters of "A Belligerent Ham" and "A Reader" are starts in a decidedly wrong direction. The amateur should watch his step and not try to hog it all, as the tendency indicated by your correspondents seems to be, or he will find that the "novice"—who already outnumbers him twenty, or more, to one—will finally turn and rend him. And he will not find the rending pleasant.

—A Novice  
Decatur, Ill.



## —RADIO INSTITUTE—

OF AMERICA

Conducted by the greatest and most experienced radio telegraph organization in the world.

Thorough training given in radio operating, traffic, all systems, including the latest successful commercial radio development of the G. H. Company, which, in one set, combines radio telephony, continuous wave telegraphy, and interrupted continuous wave telegraphy. This apparatus now installed in our school room.

Tuition Ten Dollars per month, for either the day or evening sessions, or both combined.

Prospectus mailed on request

RADIO CORPORATION OF AMERICA

Phone Douglas 3030

331 New Call Bldg., San Francisco

98 Worth St., New York. Phone Franklin 1144

Tell them that you saw it in RADIO

Warren Radio Loop Un-Covered



**The Warren Radio Loop**

Brings Your Set All Inside

Removes the danger, the nuisance of static and interference, and the damage by weather—all the hindrances of an outdoor aerial. The radio entertainment is clearer, stronger, much more enjoyable. The Warren Radio Loop takes up practically no space. Goes under a table, in any corner or odd space. Covered to exclude dust and moisture. Can't get out of order.

18 Inch Directional Loop Pivoted so that, with a honeycomb coil, you can pick up stations in all directions. Indispensable for Armstrong Receivers, Portable and Mobile Sets. Highest type aerial. Sold at most good dealers. Send for Bulletin S-102.

- Type A-737 (300-700 meters) 6 inches square—non-directional.....\$10.00
- Type A-7236 (175-1000 meters) 6 inches square—non-directional..... 12.00
- Type B-2537 (300-700 meters) 18 inches square—directional..... 20.00
- Type BL-2520 (200-18,000 meters) with honeycomb coil. 18 inches square—directional..... 25.00

**V-DE-CO RADIO MFG. CO.**  
ASBURY PARK, N. J.  
Dept. C

**EASY HOME RADIO COURSE**

7 Volumes  
Edited by Gen. Squier  
\$3.00 Per Set

**Pacific Radio Pub. Co.**  
Pacific Bldg., San Francisco, Calif.



**Na-ald De Luxe V. T. Socket**

Contact strips of laminated Phosphor bronze press firmly against contact pins, regardless of variation in length. No open current trouble possible. Socket moulded from genuine Condensite. Practically unbreakable. Special protected slot, with exterior reinforcement. Unaffected by heat of bulbs or soldering iron. All excess metal eliminated, aiding reception. May be used for 5 Watt power tube. Highest quality throughout. Price 75c.

Special proposition to dealers and jobbers

**Alden-Napier Co.**  
52 Willow St. Dept. H Springfield, Mass.

**DEALERS**

Are you ready for the holiday trade? Are your connections of such a nature that you can depend on RUSH ORDERS being put through on time? We can guarantee prompt delivery, and our discounts are most liberal.

**We Are Jobbers For**  
Grebe Receiving Sets  
Murdock Products  
Baldwin Phones  
Federal, Fada and  
Radio Shop Products

Write for our special proposition "A"

**The Radio Shop OF NEWARK**  
415 Orange Ave., Newark, N. J.

**STATEMENT OF THE OWNERSHIP, MANAGEMENT, CIRCULATION, ETC., REQUIRED BY THE ACT OF CONGRESS OF AUGUST 24, 1912,**

Of RADIO, published monthly at San Francisco, California, for October 1, 1922.

State of California, County of San Francisco, ss.

Before me, a notary public in and for the State and county aforesaid, personally appeared H. W. DICKOW, who, having been duly sworn according to law, deposes and says that he is the Business Manager of RADIO and that the following is, to the best of his knowledge and belief, a true statement of the ownership, management, etc., of the aforesaid publication for the date shown in the above caption, required by the Act of August 24, 1912, embodied in section 448, Postal Laws and Regulations, printed on the reverse of this form, to wit:

1. That the names and addresses of the publisher, editor, managing editor, and business managers are:

Publisher, Pacific Radio Publishing Co., Inc., Pacific Bldg., San Francisco. Editor, Arthur H. Halloran, Pacific Bldg., San Francisco; Managing Editor, none; Business Manager, H. W. Dickow, Pacific Bldg., San Francisco.

2. That the owners are: Arthur H. Halloran, Pacific Bldg., San Francisco; H. W. Dickow, Pacific Bldg., San Francisco.

3. That the known bondholders, mortgagees, and other security holders owning or holding 1 per cent or more of total amount of bonds, mortgages, or other securities are: None.

4. That the two paragraphs next above, giving the names of the owners, stockholders, and security holders, if any, contain not only the list of stockholders and security holders as they appear upon the books of the company but also, in cases where the stockholder or security holder appears upon the books of the company as trustee or in any other fiduciary, the name of the person or corporation for whom such trustee is acting, is given; also that the said two paragraphs contain statements embracing affiant's full knowledge and belief as to the circumstances and conditions under which stockholders and security holders who do not appear upon the books of the company as trustees, hold stock and securities in a capacity other than that of a bona fide owner; and this affiant has no reason to believe that any other person, association, or corporation has any interest direct or indirect in the said stock bonds, or other securities than as so stated by him.

H. W. DICKOW,  
Business Manager.

Sworn to and subscribed before me this 21st day of September, 1922.

(Seal) JOHN WISNOM,  
Notary Public in and for the City and County of San Francisco, State of California.  
My commission expires August 14, 1928.  
Form 8526.—Ed. 1922

**GET INTO COMMERCIAL**

**RADIO**

The Most Rapidly Growing Field Today

**\$2,500 to \$10,000 a Year**  
Positions are Waiting

No field is growing faster than Radio. No field has more to offer to the trained man. What's more important, a man can prepare himself for a good-paying position, with short hours and clean, pleasant work, in a remarkably short time. Ernest Bostwick completed our course in only ten weeks! Think of it, you can be a trained radio man ready to take a position in one of the big land stations by next summer. Or, if you want to travel and see the world, you can take charge of a ship station. It would take you three or four years to learn most any of the modern professions and then, after you finish, you would have to work hard for your salary. But not so with radio! It is an uncrowded, growing field, where the work is interesting, the pay good, and the hours short. Everybody respects a "wireless man," too. No knowledge of electricity required. If you can read and write, you can get into Radio.

**LEARN AT HOME DURING SPARE TIME**

The National Radio Institute has revolutionized home radio instruction. We have trained 10,000 men since 1914, and the field is now calling for thousands more. Our course is one of the few that has been recognized by the United States Government. Radio is a fascinating study, too. Think of messages—code, voice and music—flying through the air at a speed of 186,000 miles a second! You can learn to pick them up quickly and easily. And you can learn to design, build, install, maintain and repair the sets that transmit and receive these messages. With four to six months' instruction with the National Radio Institute you can get a training that will bring you more salary to start with than you would receive after a four-year college course.

Instruments Furnished for Practice National Radio Institute training is practical training. We supply you with instruments that give you actual practice at home. You learn the code with the Code-o-meter. Our course quickly qualifies you for a 1st Class Commercial License, which is your passport to the big-pay jobs, up to \$10,000 a year, waiting for you in this great field. Our employment bureau assists all graduates to positions.

**FREE BIG BOOK ABOUT RADIO**

We cannot begin to tell you all the interesting things about radio that you should know. Send for our big book, "How to Learn Radio at Home." It's Free. Read all about our remarkable short-cut course.

our **RADIO INSTRUMENTS**, and how we quickly qualify you for a Commercial License in your spare time at home. Send the coupon or a postal TO-DAY.



**National Radio Institute**  
Dept. 1280 Washington, D. C.

National Radio Institute, Dept. 1280, Washington, D. C.  
Gentlemen: Send me your free book, "How to Learn Radio at Home." Tell me about your Home Study Course and how when I graduate you help place me in a good position. (Please write plainly.)

Name ..... Age .....  
Address .....  
City ..... State .....

Tell them that you saw it in RADIO

# ARE YOU FROM MISSOURI?

Mounted  
\$4.50

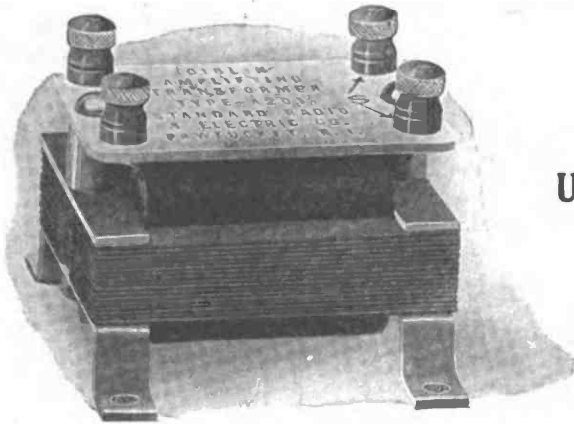

Unmounted  
\$3.50

Mounted Type A 201  
In one month this Transformer has received approval from Main to California.

### THEN TRY THIS

Giblin Audio Frequency Amplifying Transformer. Designed for use with standard amplifying tubes. Maximum amplification without noise or distortion. May be placed in any position without pre-magnetic coupling or squealing.

Pawtucket, Rhode Island

## STANDARD RADIO & ELECTRIC CO.

Liberal discounts to dealers

## "LORAIN"

The coupler with the perfect mounting.

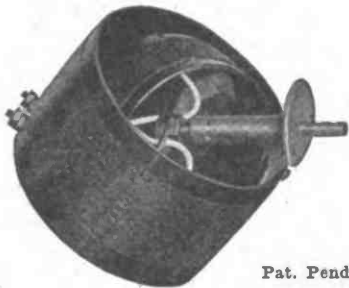

Pat. Pend.

Loose windings, twisted taps that break, noisy rotor connections, and wobbly shaft are enough to make anyone mad; use a Lorain Coupler and rid your set of these troubles. This coupler is designed to WORK. Price \$5.50 Post Paid.

If your dealer cannot supply you order direct. — Dealers write for discounts.

For complete description send for circular C2.

Lorain Radio Supply Co.  
Lorain, Ohio

## MICON

Tested Mica Condensers

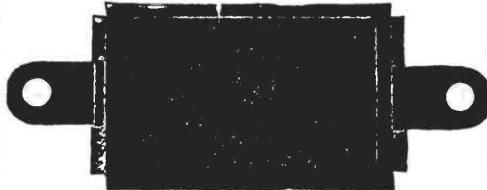

ALL CAPACITIES

Price 25c to \$6.00

## ANTENNELLA



No antenna or aerial needed

At your dealer's—\$2.00

If he can't supply you send purchase price and you will be supplied promptly without further charge.

CHAS. FRESHMAN COMPANY, INC.  
97 Beekman St. New York City

## Our 3 Factories

are dedicated to building only the finest radio apparatus. Every one of our complete outfits and separate parts carries our unqualified guarantee.

**MARVEL** Receives wireless telephone, music and speech in 30 miles radius, telegraph 300. With antennae and insulated wire, headPHONE, switches, etc. Range 180 to 2600 meters. Nothing additional required

**MARVEL** In cabinet, providing greater selectivity and range, with double headphones, antennae, switches, etc. Complete \$25.

Also a complete line of high grade separate parts guaranteed unconditionally as best

**FREED-EISEMANN RADIO CORPORATION**  
255 Fourth Avenue New York, N. Y.

## CALLS HEARD

Continued from page 96

By 8YU, Y. M. C. A., Dayton, O.  
1bcg, 1bi, 1cm, 1gv, 1xm, 2awf, 2aw1, 2bqd, 2ekl, 2fc, 2xl, 2xq, 3afb, 3apr, 3bhm, 3bhl, 3bpw, 3ckl, 3dh, 3do, 3go, 3gr, 3hl, 3iw, 3lr, 3nb, 3ot, 3tb, 3vw, 3zo, 3zw, 4bx, 4di, 4en, 4fg, 4id, 4gh, 5cy, 5da, 5di, 5do, 5ek, 5el, 5ew, 5fj, 5fv, 5kc, 5pl, 5pv, 5px, 5ql, 5ax, 5uo, 5xd, 5su, 6ea, 6ka, 6xa, 7cc, 8acb, 8ach, 8acw, 8afd, 8agd, 8ago, 8aim, 8aiw, 8aly, 8ame, 8an, 8anb, 8aoo, 8ard, 8apw, 8asj, 8ats, 8ave, 8avf, 8awk, 8awl, 8awo, 8abv, 8axb, 8axc, 8azd, 8azm, 8bas, 8bbe, 8bbv, 8bcy, 8bda, 8bdu, 8bea, 8bef, 8bfm, 8bfn, 8bf, 8bie, 8bk, 8bke, 8bja, 8bgn, 8bog, 8bpi, 8br, 8brl, 8bso, 8bas, 8bt, 8bum, 8buo, 8bvh, 8bwb, 8bwk, 8bxm, 8bx, 8byp, 8ccb, 8cbm, 8cbx, 8cdk, 8cei, 8cfp, 8cgx, 8cgm, 8cjs, 8cko, 8ckv, 8ckz, 8cmi, 8esp, 8eur, 8cwr, 8cxp, 8ej, 8dz, 8fv, 8gm, 8iq, 8hn, 8oc, 8oe, 8on, 8ok, 8qm, 8ab, 8td, 8tj, 8zz, 9aap, 9abh, 9abu, 9aep, 9ac, 9abm, 9ahy, 9agm, 9ala, 9al, 9ajg, 9ame, 9ana, 9and, 9apr, 9apw, 9aur, 9aux, 9aw, 9awm, 9aws, 9axc, 9axh, 9axu, 9axw, 9ays, 9ba, 9bai, 9bas, 9bds, 9bcx, 9bet, 9bft, 9bhe, 9bik, 9bj, 9bft, 9bkj, 9bkp, 9bls, 9bly, 9bmn, 9bno, 9bok, 9bop, 9bpw, 9brk, 9cba, 9cbu, 9cd, 9cdc, 9cdg, 9cgn, 9cgz, 9ch, 9cp, 9cja, 9cva, 9cwg, 9dag, 9dda, 9dgu, 9dhz, 9dky, 9dpl, 9dad, 9dsw, 9du, 9dww, 9dyn, 9day, 9fm, 9gk, 9io, 9kwe, 9lq, 9mc, 9me, 9mic, 9pd, 9pp, 9pn, 9qk, 9qx, 9zb, 9uz, 9uu, 9um, 9yah, 9ym, 9yu, 9xt, 9za, 9zx, 9zif, 9zv, 9zn. Can.—3dh.

Above stations all heard on one wire antenna between steel buildings. 8YU would like to know why amateurs don't listen in on 375 meters once in a while. 8YU's 1/2 K. W. 500 cycle spark is QSA vy, anywhere east of the Rockies, but no one to work while we are on that wave. Since putting our C. W. on 200 meters we find we can at least do a little work, but know our 375 meter spark would be easier copying on 375.

By 9DB, 1830 Stevens Ave., Minneapolis, Minn.

C. W.: 1xu, 1yk, 1bko, 1cmk, 2fp, 2gr, 2kl, 2nz, 2qz, 2sk, 2brb, 2ba, 2fs, 2gk, 2lp, 2lr, 2pb, 2pc, 2zo, 2aw, 2afb, 2ajd, 2auu, 2auy, 2bhm, 2bnu, 2bvc, 2bo, 2dq, 2eb, 2ft, 2jk, 2ba, 2de, 2di, 2do, 2ek, (2el), 2fb, 2he, 2je, (2ke), 2lb, 2ma, 2nc, (2nv), 2nk, 2px, 2qs, (2af), 2sm, 2tj, 2uo, 2vm, 2xd, 2za, 2zh, 2acj, 2anu, 2cap, 2dak, 2azg, 2zaw, 2zax, 2cp, 2ca, 2ea, 2en, (2ka), 2pv, 2abx, (2arb), 2asj, 2awt, 2bmn, (2bsa), 2obr, (2xad), 2lu, (2sc), 2zb, 2zo, 2zu, 2afw, 2bwa, 2ab, 2an, 2ar, (2bo), 2cl, 2ft, 2ib, 2kg, 2ow, 2ql, 2qk, 2sp, 2sv, 2wa, 2xe, 2xh, 2yd, (2ze), 2sv, 2sz, 2sz, 2sar, 2afn, 2agc, 2aim, 2aio, 2aiw, 2ajp, 2ajv, 2akp, 2ame, 2anb, 2aoe, 2aqc, 2asv, 2ati, 2atu, 2awp, 2awt, 2awz, 2axp, 2asb, 2bdo, 2bdu, (2bdv), 2bed, (2bfm), 2bke, 2bnj, 2bpl, 2bt, (2bur), 2bvr, 2bwa, 2bxh, 2bxx, 2cak, 2cay, 2cbe, 2cgm, (2cgp), 2cgx, 2cjh, (2cmi), 2cpx, (2ctp), 2cur, 2cun, 2cvt, (2zse), (2cp), (2ex), (2gk), (2ji), (2iy), (2ps), (2uu), (2zc), (2zn), (2abv), (2aq), (2ag), (2aqm), (2aqu), (2ays), (2bcf), (2bed), (2bhq), (2bji), (2bmn), (2bqw), (2bv), (2bvt), (2ccb), (2ccs), (2cfl), (2clw), (2egg), (2chm), (2dba), (2dcf), (2dhs), (2dky), (2dsm), (2dvw), (2zaf). Can.—3co, 3jl, 4bv, 9aw, 9spk: (5zac), (9abv).

By 9OIP, St. Paul, Minn.

All C. W.: 1xm, 1xu, 1ahs, 1bgl, 1bkq, 1cmk, 2gk, 2gn, 2gr, 2lo, 2ml, 2na, 2ud, 2wb, 2xq, 2zk, 2zl, 2agc, 2apa, 2awf, 2aw1, 2awa, 2ayv, 2bea, 2bfz, 2bgl, 2bgn, 2bns, 2bqd, 2bqe, 2brb, 2ekl, 2cqs, 2xap, 2bg, 2bs, 2oc, 2og, 2sk, 2fs, 2iw, 2jk, 2mk, 2rf, 2yh, 2sw, 2av, 2af, 2ans, 2apr, 2aqh, 2bj, 2bit, 2bnu, 2buu, 2bvc, 2bq, 2bv, 2dc, 2de, 2eh, 2en, 2fg, 2gh, 2ki, 2cy, 2da, 2di, 2eg, 2ek, 2er, 2fv, 2jl, 2kc, 2mb, 2mo, 2nk, 2nn, 2nv, 2of, 2pb, 2pf, 2pv, 2px, 2ql, 2rh, 2sk, 2sm, 2tj, 2tu, 2uk, 2un, 2uo, 2va, 2vm, 2vo, 2xa, 2xv, 2za, 2zu, 2ag, 2am, 2aby, 2aac, 2xad, 2zax, 2ak, 2cc, 2cu, 2gr, 2ka, 2abx, 2avd, 2ber, 2xad, 2gk, 2lu, 2zo, 2zv, 2afw, 2bk, 2bo, 2cf, 2gt, 2lt, 2ml, 2ow, 2pf, 2xg, 2yn, 2sr, 2sz, 2sz, 2aio, 2anb, 2axn, 2bdo, 2bke, 2brm, 2btd, 2bsy, 2cjs, 2cur, 2csc, 2saf, 2sag, 2lq, 2oz, 2awh, 2bji, 2bri, 2eba, 2ccv, 2ctr, 2dcr, 2dky, 2dpl, 2rac. Can.—3co, 3dh, 3ds, 3jk, 3nb, 4bv, 5jb, 9al, 9aw, 9yu.

By 6EA, 343 So. Fremont Ave., Los Angeles, Cal.

All C. W.: (Can. 4bv), 5di, (5xd), 5xad, 5za—buzzer, (6ak), (6cc), (6cp), 6fh, 6gr, 6gx, 6lo, 6nx, (6rd), 6rm, 6vi, 6abx, 6ajf, (6ajh—voice), (6aor), 6agw, (6arb), (6asj), (6awt), (6ber), 6bmd, 6bnw, (6bsa), 6bum, 6xb—voice and music, 6bnd, 6sf, 6sh, 6zi, 6zx, (6zcc), 6saf, 7bb, 7dp, 7jw, 7os, 7sc, (7th), 7xl—voice, 7sb, 7zk, 7zo, 7zu, 8cf, 8rr, (9dr), (9ps), 9amb, 9awm, 9bed, (9bji), 9ena, (9dtm), 9xm, 9yaj, (9zaf—voice), klp—voice and music, kzn—voice and music, kdpv, kdpv, kfay—buzzer, kfbk—buzzer, voice and music, nrrs—buzzer, wvw and wxy, My 5 watts A. O. C. W. was also heard by Canadian 5ej, 8ozn, 8ib, 9ag, 9aps, 9aqm, 9bed, 9blg, 9bxt, 9ctr.

DUBILIER  
DUCON  
TRADE MARK

DUCON  
\$1.50 Retail  
(By Mail 5c additional)

**ROSS RADIO SERVICE**  
693 Mission St., San Francisco

**Our 3 Factories**  
are dedicated to building only the finest radio apparatus. Every one of our complete outfits and separate parts carries our unqualified guarantee.

**MARVEL** Receives wireless telephone, music and speech in 30 miles radius, telegraph 300. With antennae and insulated wire, headPHONE, switches, etc. Range 180 to 2600 meters. Nothing additional required

**MARVEL** In cabinet, providing greater selectivity and range, with double headphones, antennae, switches, etc. Complete \$25.

Also a complete line of high grade separate parts guaranteed unconditionally as best

**FREED-EISEMANN RADIO CORPORATION**  
255 Fourth Avenue New York, N. Y.

Tell them that you saw it in RADIO



**Radio Supplies**  
**All Standard Goods**  
**Immediate Deliveries**

Distributors for  
**BALDWIN, BRANDES and FROST PHONES.**  
**MONROE RECEIVING SETS.** Atwater Kent,  
 Chelton, Chelsea Thordarsen, Burgess, Cunnings-  
 ham, Magnavox, and many others.

A COMPLETE line. Largest stock in the  
 middle west.

Write for Catalogue

DEALERS' ATTRACTIVE DISCOUNT

**American Radio Mfg. Co.**

Dept. N

107 E. 13th St. Kansas City, Mo.

**NOVO**  
**"B"**  
**BATTERIES**  
**FOR RADIO**

22½-45 & 105 VOLTS



**NOISELESS**  
**DEPENDABLE**  
**GUARANTEED**

ASK YOUR DEALER

NOVO MANUFACTURING CO.

424-436 W. 33rd ST.  
 NEW YORK

531 SO. DEARBORN ST., CHICAGO.

*free!*



Send one subscription to  
 "RADIO" and you get this  
 Dubilier Micadon — free!

State type when ordering

**"RADIO"**

Pacific Building,  
 San Francisco, Cal.

★ ★ **RADIOADS** ★ ★

A CLASSIFIED ADVERTISING SECTION READ BY BETTER BUYERS

The rate per word is five cents, net. Remittance must accompany all advertisements.  
 Include name and address when counting words.

ADS FOR THE JANUARY ISSUE MUST REACH US BY DECEMBER FIRST

**TRANSMITTING APPARATUS**

500 cycle Telefunken quenched gap Transmitting set for sale. This Transmitter radiates 12 amperes on 875 meters and 11 amperes on 200 meters. Motor Generator with 1½ horse power Wagner induction motor. D. C. end of the motor generator is used for exciter and is good for 25 amperes at any voltage up to 65 for charging storage battery. The Wagner Motor is worth \$90.00 alone. The following meters are included: 0-1500 watt meter, 0-350 volt-meter for 500 cycle use, 0-10 ampere 500 cycle ammeter and a frequency meter. Also necessary field rheostats and switches. Telefunken transformer, quenched gap, mica condensers, wave changer, two loading inductances, and 0-20 amp. thermo radiation meter. Will sell for \$250. For further details write to F. L. Wisner, Radio 62Q, 1906 Chestnut St., Berkeley, Calif.

Genuine German Telefunken H. W. Ammeters with scale reading of 0-4 amps and adjustment for temperature variations. Brand new, very exact, with original seals unbroken. Diameter 2¾ inches; regular price \$8.50—special at \$3.95. Add 30c parcel post charges. Send 5c in stamps for descriptive matter. E. Tiebout, 68 79th Street, Woodhaven, N. Y.

**RECEIVING APPARATUS**

**WESTERN ELECTRIC HEADSETS**, while they last, No. 10020, the \$15.00 grade, prepaid for \$11.25 each. A few only of the former \$12.00 grade at \$9.25 each. Grab this bargain as we have only fifty sets. Radio Supply Co., P. O. Box 842, Phoenix, Arizona.

All parts and accessories for radio you can buy from manufacturer cheap. Get price list. Continental Electric Co., 107 E. 129th St., New York City.

A **BARGAIN**—Two variable condenser .01 mfd. each. From Marconi 107A Tuner. Excellent for long waves; self shorting switch. \$10.00 each, postpaid. D. Linehan, 984 Galt Ave., Chicago, Ill.

Two Step Amplifier \$25.00; Honeycomb Regenerative including coils and Radiotron \$45.00; Variometer Regenerative including Radiotron \$45.00; Homcharger \$12.00; Radiotron Detector \$3.50. Box 205, Williamsport, Pa.

25 Mile Receiving Set Complete \$14.00. Also Regenerative units and parts at a bargain. Write for circular. Alexander Jurek, 2642 Bal-lou St., Chicago, Ill.

Several A-batteries, Willard, 6 volt 90 ampere hours, new, \$10.00 each. Robertson, 1650 Broadway, Alameda. Phone Alameda 1686-J.

Ten per cent discount on all standard radio goods. Prompt service. Superior two step Amplifier \$25.00. QST Radio Service, Williamsport, Pa. (St)

**FOR SALE CHEAP!** \$100 Receiving set like CR-9, for \$60.00. Also Magnavox for \$85. First Class! Ralph Haynes, 1280 American Avenue, Long Beach, Calif.

**MISCELLANEOUS**

**RADIO EXPERIMENTERS WIND YOUR OWN HONEY COMB AND SPIDER WEB INDUCTANCES** with the "RA-GAR UNIVERSAL" COIL WINDER. (Patent Pending). Milling machine accuracy in wire spacing guaranteed. Makes all Standard Honey Combs 25 to 1500 turns, including coils for Armstrong Super-Regenerative Circuit, Lattice wound Variometers and Variocouplers; also Spider Web or Basket Wound Inductances. Average cost per coil, Five to Ten Cents. Simple enough for a child to operate; no experience necessary. Boys make coils for profit. Professional Model makes all of above coils, \$4.50. Amateur Model for Honey Combs only \$3.00—full instructions included with each winder. (Include parcel post for two pounds.) Immediate delivery. No stamps. "RA-GAR UNIVERSAL" COIL WINDER COMPANY, Dept. 5-A, 642 22nd Avenue, San Francisco, Calif.

**FOR EXCHANGE**—1916 Chevrolet "490" Chassis, in good running order, for Magnavox and Magnavox Power Amplifier, complete with bulbs. C. E. McCartney, 901 Obapala St., Santa Barbara, Cal.

**RADIO WORLD, THE GREAT NATIONAL WEEKLY**—published every seven days with all the latest news, developments and pictures of the radio field. 16c a copy. \$6.00 a year (52 numbers), \$3.00 six months, \$1.50 three months. Special to radio readers. Send \$1.00 and we will send you the next eight issues of RADIO WORLD. Pub. Office, 1498 Broadway, New York. (to)

**NOTHING BETTER FOR CHRISTMAS** than a subscription to "RADIO" for your friend. Magazine subscriptions are a lasting gift the whole year 'round. Send us the name and address of the person to whom you desire to send RADIO and we will advise him of your generous gift in the form of a beautiful Xmas card. His subscription will start with either the December or January issue, as stated by you. Send \$2.50 today. Avoid the rush. "RADIO," Pacific Building, San Francisco.

**EASY COURSE IN HOME RADIO**, by General G. O. Squier; a complete volume of radio instruction in the form of seven books, containing hundreds of illustrations and diagrams. A most suitable Xmas gift. Price per set of seven books only \$3.00, postpaid anywhere. "RADIO," Pacific Building, San Francisco.

**TWO PAGES OF AMATEUR CALLS OF THE 6th DISTRICT** will be published weekly in "BROADCAST PROGRAM," a 32-page magazine issued by the publishers of "RADIO." First issue out on November 26th. Contains all broadcast programs for Central California. Price per copy, 5 cents. By mail \$1.00 for six months. "RADIO," Pacific Building, San Francisco.

Salesmen that have been or are calling on electric or radio trade, see Mr. Rice, 6811 N. Clark St., Chicago.

**Announcing**  
**the Publication of---**

**"Broadcast Program"**

**\$ 1.00**  
 for 6  
 months  
 (25 issues)

A 32-page weekly magazine containing programs of all Central California Broadcasting Stations—6th District Amateur Call Letters—interesting stories and photographs and a number of feature articles.

Price 5c Per Copy

**Pacific Radio Pub. Co., Inc. Pacific Building., S. F.**

Tell them that you saw it in RADIO



*These two pictures compare the thickness of the standard variable air condenser and the Dubilier Variadon*



## The New Variadon—

*No thicker than an ordinary dial*

THE following are the more remarkable features of the new Dubilier Variadon, the first practical mica variable condenser:

1. It is no thicker than an ordinary dial. Yet it serves the purpose of an air-condenser with several dozen plates.

2. It can be mounted on any convenient part of a receiver case (front or rear of panel).

3. Its adjustment cannot be destroyed by ordinary shocks, falls or vibrations. Hence short-

circuits are practically impossible.

4. It makes the vernier unnecessary.

5. It can be used as a grid-leak condenser, so that new tubes or different tubes can be adjusted to suit the receiving set.

Capacity .0004 or .0006 mfd. Retail price \$2.50.

Capacity .001 mfd. Retail price \$3.00.

Supplied complete with dial and knob.

### *Other famous Dubilier Products:*

#### **Dubilier Micadons**

Micadons are little mica condensers which reduce tube noises. Made in a wide range of capacities. Price 35 cents to \$1.50 each, according to capacity.

#### **The Ducon**

Screw the Ducon in any lamp socket and thus do away with the antenna. The broadcasting station comes in loud and clear. Price \$1.50.

#### **The Du-rec**

A chemical rectifier of which every spot is sensitive. No "cat-whisker" adjustment necessary. Does not oxidize with age. Price, mounted, 30 cents each.



# DUBILIER Condenser & Radio Corp.

48-50 West 4<sup>th</sup>. St. N.Y.

*Distributors and Branch Offices*

San Francisco, Cal.  
St. Louis, Mo.  
Washington, D. C.  
Chicago, Ill.  
Atlanta, Ga.

709 Mission Street  
Syndicate Trust Bldg.  
Munsey Building  
33 So. Clinton St.  
Forsyth Building

*Distributed in Canada by General Electric Company, Ltd., Toronto*

Tell them that you saw it in RADIO

# REMLER

*Cum gratia*

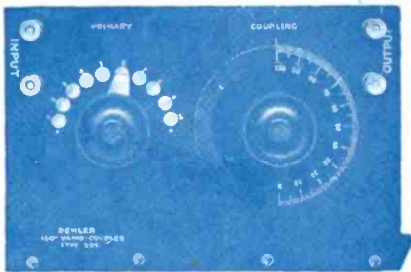

Remler Type 505 Panel Mounted Vario Coupler Price \$12.00



Remler Type 502 Panel Mounted Vanometer Price \$10.50

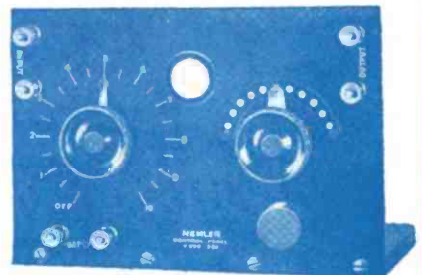

Remler Type 330 Detector Panel Price \$8.50

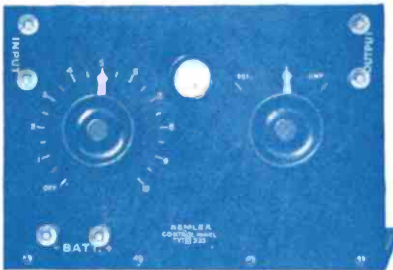

Remler Type 333 Amplifier Panel less transformer Price \$9.00



Remler Type 331 Amplifier Panel less transformer Price \$6.00

## Remler Panels Make An Ideal, Economical Receiving Set

In placing these panels on the market Remler has put a high quality receiving set within the financial reach of everyone.

When designing these Remler panel-units, Remler engineers combined every point necessary for efficiency in receiving, together with special features of construction for the convenience of the user. No process of manufacturing that would make these panels efficient in operation, beautiful and uniform in appearance has been neglected. Each panel is a complete unit mounted on a hardwood base for table use but so designed that any number of panels may be easily mounted in a single cabinet.

Remler standard parts are used exclusively in their assembly—hence it is possible, by using combinations of Remler panel units, to obtain a complete receiving set, using the same circuit employed in the most expensive receiving set on the market, at only a fraction of the cost.

*You can Start with only three panels:*

A complete and efficient receiving set for local work is obtained by connecting together Remler panels types 505-502 and 330. For long distance receptions other panels may be added one at a time to suit the convenience of the owner until the most complete and efficient circuit possible is obtained. The cost is nominal.

The diagram below shows five Remler panels connected to form a complete inductively coupled receiving set and two-stage Amplifier.

Send 10c for new Remler 40-page catalog giving prices and complete descriptions of every Remler article.

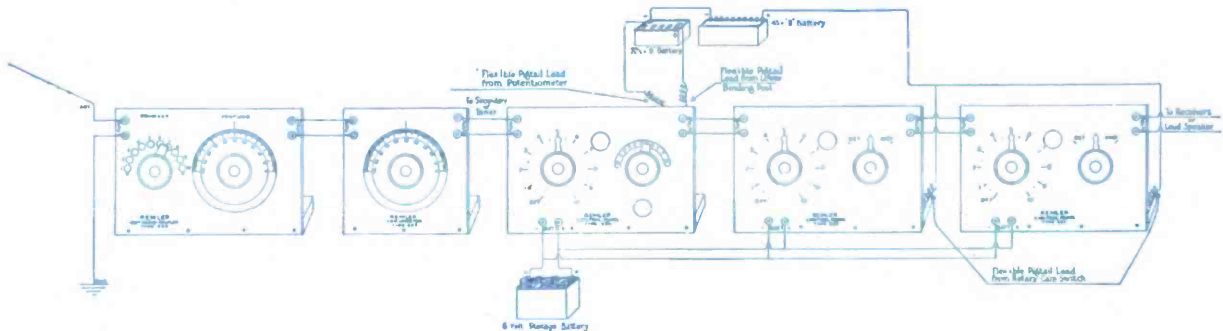

The Remler Technical Bureau is at your Service. Address your problems to Dept. R

## REMLER RADIO MFG. COMPANY

FACTORY AND HOME OFFICE  
248 FIRST STREET  
SAN FRANCISCO, CALIF.

EASTERN SALES OFFICE  
154 W. LAKE STREET  
CHICAGO, ILLINOIS

— for cottage or skyscraper —

*This will be  
A RADIO  
CHRISTMAS!*

—because there are now radio sets so supremely simple anyone can operate them, so compact they are adapted for use in any location from the tiniest cottage to the tallest skyscraper, so efficient that broadcasted programs may be received from stations both near and far with perfect ease and clearness. Such a set makes an ideal Christmas present, and you don't have to accept a substitute either, if you will go to the best radio dealer you know of and insist he show you the *A-P* quality line. Two remarkable sets from the *A-P* line are shown below.

**The Oard Phantom Receptor**



An A-P set so simple, compact, and complete within itself it can be used successfully in any location by any person who desires to receive radio programs or communications. It requires neither aerial nor ground connection. Efficient over both short and long distances. Highly selective.

**Type AR-2 Receiver Detector and two-stage Amplifier**

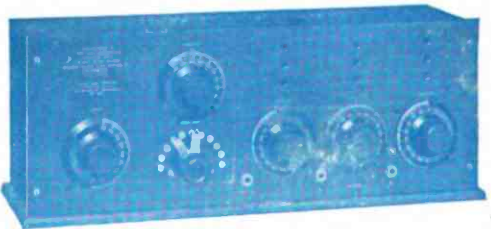

A beautiful regenerative set complete in a single cabinet. Combines ease of operation with marked sensitiveness and selectivity in action. Wave length 175 to 2,000 meters.

*The best radio dealers handle the A-P quality line. Ask the one nearest you to demonstrate the two extraordinary sets pictured above.*

If there is no A-P dealer near you write us for Bulletin R-4. In writing be sure to include the name and address of some radio dealer, together with your own name and address.

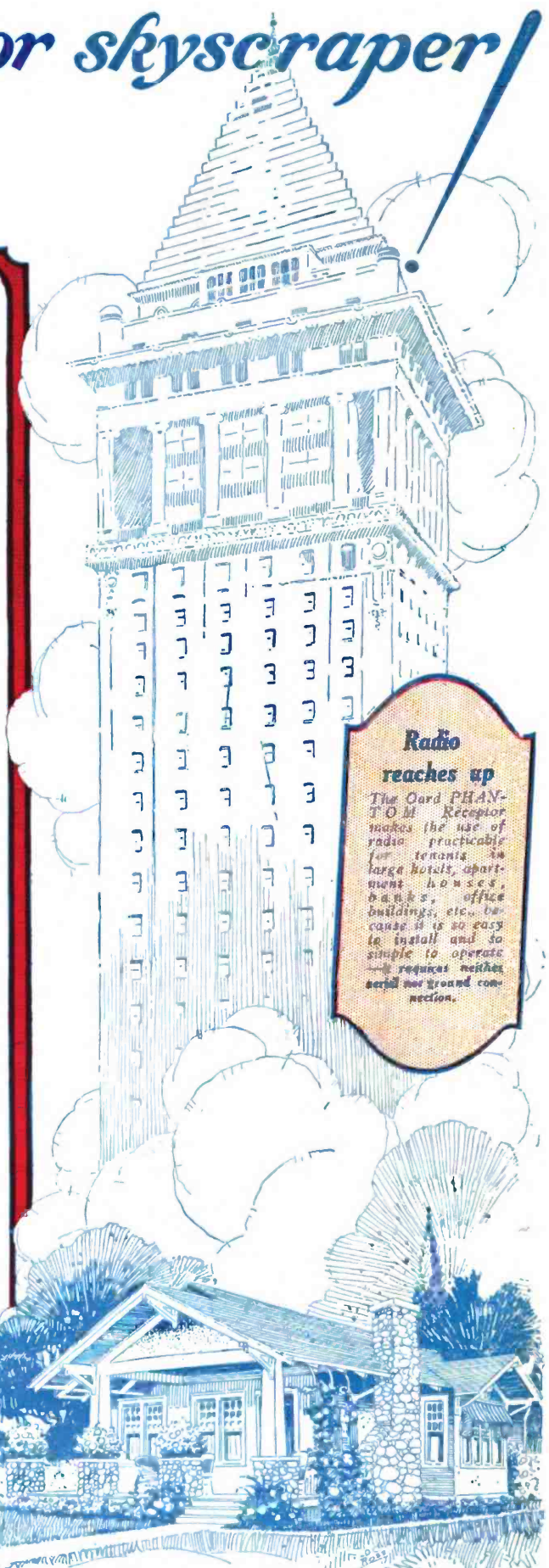

**Radio reaches up**  
The Oard PHANTOM Receptor makes the use of radio practicable for tenants in large hotels, apartment houses, banks, office buildings, etc., because it is so easy to install and so simple to operate — requires neither aerial nor ground connection.

**Atlantic-Pacific Radio Supplies Co.**  
646 Mission St. — San Francisco, Cal.